

RULES AND MASTER PLAN



**Capitol Zoning District Commission
Little Rock, Arkansas**

Adopted September 24, 1998

Amended March 25, 1999

Amended July 29, 1999

Amended December 2, 1999

Amended March 30, 2000

Amended December 7, 2000

Amended November 13, 2012

Amended May 30, 2013

Amended November 7, 2016

Amended May 17, 2018

Table of Contents

AUTHORITY & PURPOSE	4
ADMINISTRATIVE RULES & PROCEDURES.....	5
Permit Types	7
Application Process.....	13
Enforcement	16
Demolition by Neglect	17
Non-Conforming Properties	18
Appeals	20
GENERAL STANDARDS	22
Zoning Requirements	22
Use Groups	33
Zoning Maps	37
Parking Requirements	41
Signs	46
Outdoor Lighting	50
Tree Protection.....	51
REHABILITATION STANDARDS FOR HISTORIC PROPERTIES	53
Preservation Principles.....	56
Streetscape & Site Design.....	57
Building Materials.....	62
Windows	67
Doors.....	72
Porches.....	74
Architectural Details	77
Roofs	80
Additions	82
Secondary Structures.....	85
Interpretation.....	86
Architectural Styles.....	89

CAPITOL AREA MASTER PLAN 97

- Goals & Recommendations..... 101
- Capitol Area Zones 109
- Streetscape Design 111
- Capitol Area Maps 127

MANSION AREA MASTER PLAN 131

- Goals & Recommendations..... 135
- Mansion Area Zones 138
- Streetscape Design 140
- Mansion Area Map..... 147

CAPITOL AREA DESIGN STANDARDS 149

- Site Design Standards 151
- Architectural Standards..... 155
- Parking Lot Design Standards..... 160
- Landscape Standards..... 163

MANSION AREA DESIGN STANDARDS 166

- New Construction Standards for Zones M & N 168
- New Construction Standards for Zone O 178
- Parking Areas & Landscape Standards 181

ARTICLE ONE
AUTHORITY AND PURPOSE

SECTION 1 - 101 TITLE

The Capitol Zoning District Master Plan (composed of the Capitol Zoning District Rule, Capitol Area Framework Master Plan, Mansion Area Framework Master Plan, Mansion Area Design Standards, Capitol Area Design Standards, Rehabilitation Standards, and General Standards) represents the legislation, intentions, design principles, and regulations of Act 267 of 1975, as amended. These regulations are the legally accountable component by which the regulatory aspects of the Act are implemented. These regulations shall be known and may be cited as the Capitol Zoning District Master Plan or the Capitol Zoning Rules.

SECTION 1 - 102 AUTHORITY

A. By Act 267 of 1975, as amended, the Seventieth General Assembly of the State of Arkansas created a Capitol Zoning District and a Capitol Zoning District Commission to supervise zoning within the district, to develop a Capitol Zoning District Master Plan and for other purposes.

B. The Capitol Zoning District Master Plan is the official comprehensive plan for coordinating physical development in the two district areas, the Capitol Area and the Mansion Area. This plan has been adopted according to the provisions of the Arkansas Administrative Procedures Act by the Capitol Zoning District Commission and registered with the Secretary of State as the legal document which transmits Act 267, as amended, into applicable regulations and administrative actions. Any questions concerning the intent of the legislation or zoning regulations will be directed to this plan for clarification.

C. Under Section 4 of Act 267 of 1975, as amended, (A.C.A. 22-3-308), the Commission is authorized to coordinate its Master Plan with city, county, and other area planning agencies and to enter into agreements with the City of Little Rock providing for mutual cooperation and joint regulation with the district with respect to planning and zoning, permission to build upon or otherwise use land, enforcement of building, safety and health codes and inspection to assure compliance. Such agreements between the City of Little Rock and the Commission do not cede the Commission's final authority over the matters entrusted to it by law, except to the extent enforcement of the Rules is authorized by statute and agreed upon by the City and the Commission.

D. The provisions of this Rule and the Capitol Zoning District Master Plan supersede all provisions of the City of Little Rock Code of Ordinances. However, unless specifically dealt with as provisions of this Master Plan, all other regulations, requirements and codes of the city of Little Rock shall continue to be in force in the Capitol Zoning District and are adopted by reference as a part of this Master Plan.

1. The Commission may defer to the City of Little Rock for the administration of such codes, but reserves its final authority over the zoning and regulation of property within the Capitol Zoning District.

2. Any references in these Rules to the City of Little Rock's Code of Ordinances refers to it as it existed on the date the most recent changes to these Rules became effective.

E. The Capitol Zoning District Commission has exclusive authority over the zoning and regulation of all property within the Capitol Zoning District and no subdivision of the state has any zoning or control authority except as agreed upon by the Commission. Exempted from the above stated authority of the Capitol Zoning District Commission are properties owned by the state, and existing streets, alleys, utilities and/or the public right-of-way.

SECTION 1 - 103 PURPOSE

The Capitol Zoning District Rules establish special zoning regulations and design guidelines governing the development and use of land improvements within the Capitol Zoning District in accordance with the provisions of Act 267 of 1975, as amended; provide for regulations and non-conforming uses and structures; and provide for the administration and enforcement of the provisions of the Master Plan.

SECTION 1 - 104 SEVERABILITY

If, for any reason, any one or more portions of this Rule is held invalid, such judgment shall not affect or invalidate the remaining provisions of this Rule, but shall be confined to that specific statement and in no instance shall affect or prejudice the validity of the remaining portions of this Rule.

ARTICLE TWO **ADMINISTRATIVE RULES AND PROCEDURES**

SECTION 2-101 ORGANIZATION

The Capitol Zoning District shall be regulated by a Capitol Zoning District Commission as set forth in Act 267 of 1975, as amended. The Capitol Zoning District Commission will meet monthly (although it may meet more or less often, as conditions dictate) to hear matters concerning project proposals for major developments, requests for conditional use permits, requests for variances, requests for demolition or major modification of structures, requests for non-conforming use approval or renewal, appeals, summary reports on other requests, administrative matters, citizen communication, and other business as may come before the Commission.

SECTION 2-102 ADMINISTRATION

A. The administration and enforcement of the provisions of this Master Plan are the ultimate responsibility of the Capitol Zoning District Commission. The Capitol Zoning District Commission will enter into agreements with departments of the City of Little Rock relevant to the execution of this plan. However, nothing in these Rules should be construed as divesting the Capitol Zoning District Commission of any authority to regulate development within the Capitol Zoning District in the manner described herein.

B. The Capitol Zoning District Commission shall consider the recommendations of all departments, boards and committees of the City of Little Rock related to the normal review and permit procedures of the city, in arriving at its decisions on development policy, procedures and daily administration. The Capitol Zoning District Commission shall also coordinate its agenda and business meetings with those of the City of Little Rock and its departments to facilitate prompt action on all applications where joint review by the City and the Capitol Zoning District Commission are required.

C. The Capitol Zoning District Commission shall employ a director and staff to establish procedures for coordinating with the City of Little Rock and administration of this Master Plan; to establish review procedures with the various commissions and departments of the state to promote coordination of state construction projects with the provisions of this Master Plan; to establish priorities and methods for continuing the Capitol Zoning District planning process; to explore new programs, approaches and funding sources for promoting development in the Capitol Zoning District; to prepare materials for consideration by the Capitol Zoning District Commission at its meetings; and to generally direct the day to day administration of the Capitol Zoning District Commission.

D. The staff will review all projects within the District and make recommendations to the Commission on development projects and permit applications. In addition, continual research and planning will be carried on to encourage coordinated, sensitive growth in the Capitol Area and the preservation of the neighborhood character in the Mansion Area. The Capitol Zoning District Director and staff shall have the authority to act on behalf of the Commission on certain permit applications and procedural matters to eliminate undue delay in the granting of permits which are in conformance with the provisions of this Master Plan pursuant to guidelines adopted by the Commission and revised from time to time. This comprehends, but is not limited to, any or all of the permits and matters described in Section 2-105 of this Rule (all of which shall be comprehended within the terms “permit” or “permits”), subject to the limitations set forth in said Section 2-105.

SECTION 2-103 ADVISORY COMMITTEES

The Capitol Zoning District Commission shall establish three standing advisory committees: the Capitol Area Advisory Committee, the Mansion Area Advisory Committee, and the Design Review Committee.

A. Membership, terms and officers

1. The Area Advisory Committees shall consist of at least nine (9) members, and Design Review Committee at least seven (7) members. The Capitol Zoning District Commission shall receive nominations from individuals, groups and organizations and shall appoint members with the concurrence of the committee majority. Commission members may also serve as *ex-officio* members of any of the advisory committees.

2. The committee members’ terms of office and qualifications shall be determined by the committee bylaws, which bylaws shall be approved by the Commission; however, the Advisory Committees, in prescribing the terms of office, shall endeavor to provide continuity by having the terms staggered. Members of the committees representing governments or organizations shall have terms conterminous with the terms of office within the governments or organizations they represent.

3. Each Advisory Committee shall elect a chairperson and a vice-chairperson, whose terms of office shall be at least one year. The duties of the chairperson shall be to call and to conduct the meetings. The director of the Capitol Zoning District Commission shall serve as secretary to each committee and shall furnish the Commission with the records of committee meetings. Additional duties may be assigned to these offices and other offices created by the advisory committee bylaws.

B. Meetings and reports

The Advisory Committees shall meet at least once a year and shall report their findings to the Capitol Zoning District Commission at least once a year. Additional meetings will be held as often as necessary to monitor the impact of the Capitol Zoning District Master Plan on the development within the Capitol Zoning District. The Advisory Committee meetings shall be open to the public and shall be held at locations that afford the maximum opportunity for community participation.

SECTION 2-104 APPLICATION

A. All applications for permits shall be made through the procedures established by the Capitol Zoning District Commission using application forms or other information-gathering devices drafted and revised from time to time by the Director. If the application requires special consideration by, or presentation to the Capitol Zoning District Commission, the applicant will be so notified and instructed as to the date at which the application is to be considered by the Capitol Zoning District Commission.

B. No application for any permit or variance which has been denied by the Capitol Zoning District Commission will be accepted within one year of the date of denial.

C. Applications, reviews, permits and other requirements called for by this Rule are in addition to, and not in lieu of, those required by the City of Little Rock (including the MacArthur Park Historic District). However, in areas where the Commission has chosen not to exercise its authority, such as platting and subdivision of property, the ordinances of the City of Little Rock are controlling.

SECTION 2-105 PERMIT APPROVAL PROCEDURE

A. Capitol Zoning District Commission / City of Little Rock Agreement

1. Under a memorandum of agreement between the City of Little Rock and the Capitol Zoning District Commission dated November 7, 1977 and City of Little Rock Resolution Number 5,849, the City of Little Rock shall not issue the following permits for properties within the Capitol Zoning District without prior Capitol Zoning District Commission approval:

1. Building Permits
2. Sign Permits
3. Grounds Permits
4. Privilege Licenses
5. Demolition Permits
6. Certificates of Occupancy
7. Certificates of Compliance

2. All work performed within the Capitol Zoning District shall be in compliance with the Little Rock Code of Ordinances as it applies to construction, and may not be performed without a properly issued building permit.

3. The Capitol Zoning District Commission shall have sole authority for acting on and issuing Conditional Use Permits and Variances.

B. Work Not Requiring a Permit

Ordinary maintenance (such as lawn mowing, shrub trimming, re-painting, etc) shall not be considered modifications and will not require a CZDC permit. Nor shall work affecting only the interior of a structure (such as plumbing, insulation, flooring, etc) require a CZDC permit.

C. Permits / Types - The Capitol Zoning District Commission or staff may issue the following permits:

1. Certificates of Appropriateness

a. A Certificate of Appropriateness must be obtained prior to effecting any major modification or addition to a structure, site or improvements within the District. *Major modifications* are those which substantially alter, from the public right-of-way, the appearance of a structure or site feature. Applications for major modifications requiring Commission review will first be scheduled for a review by the Design Review Committee which will make a recommendation regarding proposed work's appropriateness of the modification to the historical style of the structure and neighboring structures; compatibility with its architectural, historical or cultural significance and level of intactness; and its consistency with the goals of the Commission's Master Plan and Standards. Capitol Zoning staff may issue a Certificates of Appropriateness for major modifications only when:

(i) The proposed changes substantially comply with all applicable review standards; or

(ii) There is substantive and compelling evidence (photographic, documentary, or physical) to indicate the proposed work will return a property to a probable earlier appearance.

b. A Certificate of Appropriateness shall also be required for the erection of any new structure, including accessory structures, or site improvements, such as retaining walls, fences, ponds, or pergolas. Movable items, such as furniture, shall not be considered structures or improvements. Applications for new construction requiring Commission approval will first be scheduled for a review by the Design Review Committee which will make a recommendation regarding proposed work's appropriateness in historical style in the context of adjoining or neighboring structures; and its consistency with the goals of the Commission's Master Plan and Standards. Capitol Zoning staff may issue Certificates of Appropriateness for new construction only when the proposed changes substantially comply with all applicable review standards, and:

(i) The proposed new construction is not a structure; or

(ii) The proposed new construction is an accessory structure similar to those traditionally seen in the District, such as storage sheds, unenclosed walkways, gazebos, animal enclosures, tree houses, carports, green houses, etc.

c. A Certificate of Appropriateness shall be required for the total or partial destruction of any structure, accessory structure or site improvement. Applications for demolition which require approval of the Commission, will first be scheduled for a review by the Design Review Committee which will make a recommendation regarding the architectural, historical or cultural significance of the structure or improvement; the impact of its demolition on the character of the neighborhood and the District and on the goals of the Master Plan; the physical and economic possibilities for its rehabilitation, taking into account the source of any alleged deterioration in the condition of the structure or improvement, i.e., whether the condition was caused or contributed to by neglect. Capitol Zoning staff may issue Certificates of Appropriateness for demolition only when:

(i) The structure, or site feature proposed for demolition is not historic and not the primary building on a site; or

(ii) The structure, addition or site feature has been determined to be an imminent and irreparable hazard to public safety by a city or state official responsible for such determinations, and staff agrees with the determination.

d. Under no circumstances will staff issue a Certificate of Appropriateness that will cause a property to become non-conforming, or that will serve to intensify a property's existing non-conformance, with the General Standards.

e. In cases where more than 75% of the historic true divided light windows of one design in a structure are totally destroyed due to an act outside the owner's control, the CZDC staff may issue a Certificate of Appropriateness for the replacement of such windows with windows that are substantially identical to the historic windows in the configuration of the panes, the dimensions of all defining elements such as panes, muntin, mullions, and sash, the reveal, and sash and glazing materials. This includes the approval of double glazed simulated divided light windows which include a paintable fixed exterior applied muntin and a spacer bar dividing the double panes of glass if such windows appear substantially identical to the historic windows from the public way. The determination of whether a window appears substantially identical to the original shall be made by the CZDC staff after an inspection of the proposed replacement windows. In no case shall a new window be considered substantially identical if the linear dimensions of any element visible from the public right of way vary by more than 10% from the dimensions of the historic window it is to replace. For the purposes of this section, "an act outside the owner's control" shall not include normal deterioration due to weathering, insect infestation, or other similar maintenance issue.

2. Conditional Use Permits - Each zone within the Capitol Zoning District allows for one or more use groups as to be allowed as conditional uses (see Section 3-201). The conditional uses listed for each zone are understood to be acceptable for that zone, but are more intensive land uses than those allowed by right. Applications for Conditional Use Permits are therefore reviewed by the Commission on a case-by-case basis to allow Commission to set any conditions that the Commission finds will make a proposed use more consistent with the goals of the Master Plan.

- a. The Commission shall grant a Conditional Use Permit to permit a use of land not permitted by right under the zoning applicable thereto, provided that the conditional use in question is permitted for that zone, but may attach additional conditions that will serve to make the proposed use more compatible with the surrounding neighborhood and the District as a whole.
- b. A Conditional Use Permit may not be granted at the staff level.

3. Variances - The General Standards (Article 3) allow the Commission to waive several of its provisions on a case-by-case basis. In some extenuating circumstances, however, such waivers may not be sufficient to allow for the appropriate, compatible development of a site. In such cases, the Commission may issue a Variance to grant additional relief from the literal provisions of the General Standards when it is demonstrated to the Commission's satisfaction that the proposal will be otherwise consistent with the goals of the Master Plan; and

- a. The proposal will, based on sound documentary, photographic, or physical evidence, restore a historic property to its original appearance, or to another historic configuration dating from the District's period of significance; or
- b. The proposal will afford the least intrusive solution possible; and
 - (i) physical or topographical conditions unique to the land (such excessive slopes, natural features worthy of conservation, etc), which were not created or intensified by the applicant or a previous owner, will result in an extreme hardship if the literal requirements of the General Standards are applied, resulting in the deprivation of any reasonable use of the property; or
 - (ii) the preservation of a historic or archeological resource will result in an extreme hardship if the literal requirements of the General Standards are applied, resulting in the deprivation of any reasonable use of the property.

Under no circumstances shall the Commission grant a Variance to allow a use not identified as a permitted or conditional use within a given zone, nor to allow for building heights in the Capitol Area greater than the allowed maximums. A Variance may not be granted at the staff level.

4. Certificates of Economic Hardship - The Commission may issue a Certificate of Economic Hardship following the denial of a proposed modification to a historic property if it is demonstrated to the Commission's satisfaction that the literal requirements of the Rehabilitation Standards, if applied, will deprive the property owner of a reasonable economic return or beneficial use from the property, and the proposed work will be otherwise consistent with the applicable Design Standards and Master Plan.

- a.** An applicant may request a proposal be considered for a Certificate of Economic Hardship immediately following the denial of a Certificate of Appropriateness for the subject property. An applicant may also choose to apply concurrently for a Certificate of Economic Hardship and a Certificate of Appropriateness.

- b.** If an applicant fails to avail themselves of either of the options above, the applicant may submit an application for a Certificate of Economic Hardship within fifteen (15) calendar days from the date of the notice of denial by the Commission. Such applications shall be subject to the same notice provisions applicable to all other permits.

- c.** It shall be incumbent on the applicant to demonstrate economic hardship to the Commission's satisfaction. The applicant for a Certificate of Economic Hardship shall submit the following information, as applicable, for the Commission to make a determination on the application:
 - (i)** Estimate the cost of the proposed work and an estimate of any additional cost that would be incurred to comply with the Commission's Rules for changes necessary for the issuance of a Certificate of Appropriateness;

 - (ii)** A written opinion from a professional engineer or architect, licensed to practice in Arkansas with experience in rehabilitation, as to the building's suitability for rehabilitation relative to its current structural condition and proposed new use. The opinion can be based on visual observation only and is not intended to declare a building "safe" or "unsafe", nor to be a comprehensive report on feasibility of rehabilitation.

 - (iii)** Estimated market value of the property in its current condition; after completion of the work; after any changes recommended by the Commission; and, in the case of a proposed demolition, after renovation of the existing property for continued use;

 - (iv)** In the case of a proposed demolition, an estimate from a licensed architect or contractor, appraiser, or other real estate professional experienced in rehabilitation as to the economic feasibility or rehabilitation or reuse of the existing building or structure on the property;

- (v) Amount paid for the property, the date of purchase, and the party from whom purchased, including a description of the relationship, if any, between the owner of record or applicant and the person from whom the property was purchased, and any terms of financing between seller and buyer;
- (vi) If the property is income-producing, the annual gross income from the property for the previous two (2) years, itemized operating and maintenance expenses, and depreciation for the previous two (2) years; and annual cash flow before and after debt service, if any, during the same period;
- (vii) All appraisals obtained within the previous two (2) years by the owner or applicant in connection with the purchase, financing, or ownership of the property;
- (viii) Any listing of the property for sale or rent, price asked and offers received, if any, within the previous two (2) years;
- (ix) Assessed value of the property according to the two (2) most recent assessments;
- (x) Form of ownership or operation of the property, whether sole proprietorship, for-profit or not-for-profit corporation, limited partnership, joint venture, or other; and,
- (xi) Information about plans prepared for the property, if a building or structure is demolished, including material on the timing and financing of the new construction.

d. The Commission may seek expert testimony on the foregoing and may request the submission of any other information reasonably considered necessary to make a determination as to whether the property does yield or may yield a reasonable economic return or beneficial use to the owner.

e. If the Commission makes a finding of economic hardship, based on the evidence and information submitted, it may grant a Certificate of Economic Hardship to approve the work proposed by the applicant. The Commission may choose not to grant approval if it determines the alleged hardship was created and/or exacerbated by action or inaction on the part of the applicant, or if it determines the proposed work is otherwise inconsistent with the applicable Design Standards or Master Plan.

5. Certificates of Compliance - Certificates of Compliance may be issued by the Capitol Zoning District Commission staff certifying that any minor modification, proposed land use, or other development has been reviewed under the applicable provisions of this ordinance and is in compliance with the requirements of this Rule.

- a.** Permits for minor modifications may be issued by the staff after a determination that such modifications are in compliance with the CZD Rules. *Minor modifications* are those which
 - (i) do not substantially alter the appearance, from the public right of way, of a structure, site or improvements; or

(ii) involve only replacing or repairing existing elements (such as like-kind window or roof replacements); or

(iii) involve only changes to a vehicular use area; or

(iv) involve only signage; or

(v) involve an accessory structure not visible from the public right of way; or

(vi) involve only installation of satellite dishes, antennas, and similar devices.

b. Permits for minor modifications may be issued by the staff after a determination that such modifications are in compliance with the Rules.

c. "Like-kind replacements" shall be defined as the replacement of an architectural feature with a feature identical to the original in materials, design, and functionality. For instance, replacement of damaged historic true divided light wood casement windows with new true divided light wood casement windows identical to the historic windows in the configuration of the panes, the dimensions of all defining elements such as panes, muntin, mullions, and sash, the reveal, and the materials.

d. Additionally, Certificates of Compliance may be issued by the Capitol Zoning staff certifying that a proposed land use is allowed by right.

6. Temporary Use Permit - A Temporary Use Permit may be issued to permit an activity and associated temporary signage that otherwise is not allowed by right.

a. Staff may issue a Temporary Use Permit for an activity that would otherwise require a Conditional Use Permit and/or full enclosure if staff determines the proposed activity substantially complies with all of the following standards:

(i) The proposed use or activity is so designated, located and proposed to be operated in such a manner that the public health, safety and welfare will be protected.

(ii) The proposed use or activity is compatible with and will not adversely affect other property in the area where it is proposed to be located.

(iii) The proposed use or activity would not exceed fourteen (14) days in duration.

(iv) All requirements of other public agencies would be met.

(v) Any associated signage would not be permanently affixed, would not exceed thirty-six (36) square feet, and would be removed in a timely fashion following the proposed use or activity.

(vi) The maximum time approved for all Temporary Use Permits issued by staff for the property in question would not exceed eight (8) weeks per 12-month period.

b. If the Staff determines all of these standards will not be met, the application shall be scheduled for a public meeting before the Commission. The Commission will also review all Temporary Use applications for activities which would otherwise be prohibited.

(i) When reviewing requests for Temporary Use permits, the Commission shall consider the criteria above, as well as the impact of the proposed activity on the property, on neighboring properties, and the goals of the Master Plan.

(ii) A Temporary Use Permit may be granted by the Commission for any time period up to one year from the date of issuance.

D. Staff Issuance of Permits Approved by the Commission - The Commission may delegate to the Staff the drafting of such permits (including modifications and extensions) without additional review by the Commission.

1. Staff may approve modifications to a permit that are consistent with all applicable review criteria and do not substantively change the nature of the work or use approved by the Commission.

2. Except for a permit with a maximum time limit prescribed by the Commission, the Director may, at his or her discretion, extend a permit for construction, modifications, or demolition once, for a period not to exceed one year.

3. The Commission may require that evidence of any permit be posted and maintained on the affected property on a form or sign to be provided by staff.

E. Permit Expiration

Permits shall be construed to run with the parcel of land for which they are granted, not to a particular applicant or property owner. A new owner and/or tenant of a given property shall not be required to obtain a new permit for the continuation of an allowed or permitted use or project. Permits may, however, expire under the following circumstances:

1. Unless otherwise prescribed by the Commission, or extended by the Director in accordance with D.2 (above), permits for construction, modifications, or demolition shall expire one (1) year after issuance if work is not commenced and diligently pursued within that time period. Permits for work that is commenced shall also expire one (1) year after work is discontinued.

2. Permits, other than Variances and Temporary Use Permits, issued for the use of land shall expire after any one (1) year of continuous disuse. Such expirations shall be construed as abandonment of the use.

3. Variances issued prior to January 1, 2017 shall expire after any six (6) months of continuous disuse. A Variance issued after January 1, 2017 shall expire when the use of the land, at the time the Variance was issued, is abandoned.

4. A Temporary Use Permit shall expire on the date prescribed by the permit.

F. Application Review Procedures

The following procedures shall be followed in the consideration of any permit:

1. All changes in the Capitol Zoning District will be evaluated according to the General Standards and the applicable Area Master Plan. Also,

a. Changes to historic structures or site features shall be evaluated according to the Rehabilitation Standards for Historic Properties.

i. Structures and site features 40 years or older are assumed to be historic, unless they have been significantly altered, and reversing the alteration(s) would be impossible or wholly unreasonable. (In some cases, structures or site features less than 40 years old may also be considered historic if they are of exceptional architectural or cultural significance.)

ii. The Commission may waive the Rehabilitation Standards for cause (see Section 4-101 C.), in which case a proposed change to a historic structure or site feature shall be evaluated according to the applicable Design Standards.

b. Changes to all other (non-historic) structures and site features, as well as new construction, shall be evaluated according to the applicable Design Standards.

2. Application

a. The applicant shall file an application form and any additional information requested by the Capitol Zoning District Commission staff.

b. Staff shall review the application and shall determine whether the requested permit can be issued by staff. Within five business days of receipt of an application:

(i) If the permit can be issued by staff, according to section 2-105(C), staff shall issue the permit.

(ii) If staff determines that the proposed work and/or use is not substantially consistent with the applicable review criteria, staff may deny the application. If staff denies an application, staff shall provide the applicant with written reasons for the denial.

(iii) If staff is unable to determine whether the proposal can be approved by staff, or if the request otherwise requires Commission approval (such as with conditional uses), staff shall schedule a review at an upcoming meeting of the Capitol Zoning District Commission. Staff shall notify the applicant of the date time and location of the Commission meeting, as well as of any advisory committee meetings at which the application will be considered.

c. For an application requiring a review by the Commission, the Director shall notify surrounding property owners as follows:

(i) The Director will give not less than ten (10) calendar days written notice of the time, place and the date of the review meeting to all owners of record of property situated within 200 feet of the property for which the permit is requested. The notice shall be sent by first-class mail to the last known address of such recorded owners(s), unless a property owner has previously requested, in writing to the Director, to be notified by email or other written means.

(ii) The Director shall post a sign near the front of the property so that it can be seen from the street, at least ten (10) calendar days before the meeting.

(iii) The applicant or a representative of the applicant is required to be present at the meeting in order to answer any questions that the Commission or interested parties may have.

- d. Lack of representation may cause an application to be withheld and not considered at the appointed time and may require the re-filing of the application and the re-notification of property owners at the applicant's expense.

3. Staff Report

In preparation for the review, a report by the Staff shall be prepared and submitted to the Commission recommending approval, approval with conditions, deferral, or denial of the permit. The Commission shall consider the staff report along with other evidence presented at the review meeting, but shall not be bound by the recommendations of the report.

4. Commission Review and Public Input

The Commission review contemplated in this section, and elsewhere in this Rule, is meant to allow members of the public, in addition to the applicant(s), to present before the Commission any relevant testimony or evidence relating to an application for a permit. These reviews may be conducted informally, and shall not be construed as administrative adjudications, as contemplated under the Arkansas Administrative Procedures Act.

5. Decision

- a. In reviewing the application, the Commissioners shall consider the application and base their decision upon the report of the Staff, the recommendations of the Design Review Committee, advice from Advisory Committees, impact of the proposal on the property, neighboring properties, the District as a whole, the goals of the Master Plan, any applicable review criteria, and the evidence or testimony presented by the applicant(s) and other interested parties. The Commission shall approve the permit(s) if it finds the proposal to be substantially consistent with the applicable review criteria. If the Commission approves an application as submitted, staff shall issue the permit to the applicant within five business days of approval.
- b. The Commission may approve an application, contingent on conditions that the Commission has determined would make a proposal more consistent with the applicable review criteria. If the Commission approves an application with conditions, staff shall issue the permit to the applicant within five business days, or within five business days of the fulfillment of any requirements set by the Commission as conditions of issuance.
- c. The Commission shall deny an application if it finds the proposal is not substantially consistent with the applicable review criteria, and shall state its reasons for denial in the record. If the Commission denies a permit, staff shall notify the applicant in writing within five business days the reasons given for the denial.
- d. The Commission may defer an application until its next regular meeting at the request of the applicant, to collect additional information, or for other cause.
- e. Unless an applicant affirmatively consents to a longer time period, the Commission shall act on an application within 100 calendar days of submittal of a completed application. If an applicant has not consented to a longer deferral period, and the Commission has not taken final action within 100 days, the application shall be construed as approved, and staff shall issue the permit upon request of the applicant.

SECTION 2-106 ENFORCEMENT

Any citizen of Arkansas may report to Staff, by written, verbal, or electronic communication, any potential violation of the Rules. Staff will investigate, in a timely fashion, every alleged violation reported. Staff will also regularly monitor the District for potential violations.

A. If the Staff finds that a violation may have occurred or be occurring:

1. Staff shall notify the property owner of record of this preliminary finding, stating the reasons therefore, and shall give the owner thirty (30) days from the date of notice to submit a proposal for work rectifying the specific concerns. The notice to the property owner shall also include information on possible financial incentives that may be available. Such notice shall be accomplished in the following manner:

a. By mail to the last known address of owner; or

b. In the event that **(a)**, above, is not successful, then such notice shall be attached to the building or improvements twice within a week.

2. If the owner fails to submit an application within thirty (30) days from the date of notice (described above), the Staff shall notify the owner in the manner provided above to appear at an upcoming meeting of the Commission for a show cause hearing.

a. The show cause hearing shall be conducted as an administrative adjudication, in conformance with the provisions set forth in the Arkansas Administrative Procedures Act.

b. Staff shall present to the Commission at the show cause hearing the reasons for the notice, as well as any applicable evidence or expert testimony, and owner shall have the right to present any rebuttal thereto. If the owner fails to show adequate cause to stay further action, the Commission may determine that a violation exists and issue an order to compel corrective action.

c. In accordance with the Arkansas Administrative Procedures Act (A.C.A. 25-15-217), the order may include:

i. revocation or suspension of any permits previously issued for the property in question, or for any other property in the District held by the same owner(s); and/or

ii. a request to the Attorney General to seek appropriate injunctive relief; and/or

iii. other legal remedies compelling corrective action.

d. In accordance with Act 1338 of 2013 (A.C.A. 22-3-308(b)), the order may also include a request to the City of Little Rock to pursue enforcement action in Little Rock District Court, in the same manner as a violation of a municipal ordinance.

e. The Commission may file a lien against the property equivalent to any costs associated with implementing any corrective actions.

f. The owner is not required to be present at the hearing for the Commission to find that a violation has occurred or is occurring.

B. Staff may not accept applications from, or on behalf of, individuals or legal entities that own property or properties within the District on which one or more unresolved outstanding violations of the Rules exist, except applications to specifically reverse or otherwise correct the outstanding violation(s).

C. The undertaking of any work or use that was denied by the Commission or staff, but not subsequently reversed on appeal (see Section 2-109), shall also be construed as a violation of the Rules. If staff observes such work or use has occurred or is occurring:

1. Staff shall not accept any new applications, in accordance with Section 2-106 (B); and

2. The Commission shall hold a show-cause hearing, according to the procedure described in Section 2-106 (A), to determine the appropriate corrective action and issue an order.

D. An approved permit and arrangements to correct a violation or violations may serve to stay proceedings under this section. Nothing in this section shall be construed to prohibit the informal disposition of a violation or an alleged violation by settlement, stipulation, or other agreement between the property owner(s) and the agency.

SECTION 2-107 DEMOLITION BY NEGLECT

A. No owner or person with an interest in real property located within the District, including but not limited to Sole Proprietors, members of Limited Liability Companies and shareholders in closely held corporations, shall permit said property to fall into a state of disrepair. The owner or person with an interest in the real property in charge of any building or structure within the District shall keep in good repair all of the exterior portions of the structure and all interior portions which, if not so maintained, may cause the exterior portions of the structure to deteriorate, decay or become damaged or otherwise to fall into a state of demolition by neglect.

B. Demolition by neglect shall be defined as neglect in the maintenance of any building or improvements resulting in any one or more of the following:

1. The deterioration of a building to the extent that it creates or permits a hazardous or unsafe condition as determined by the City of Little Rock.

2. The deterioration of a building(s) characterized by one or more of the following:

a. Those buildings which have parts thereof which are so attached that they may fall and injure members of the public or property.

b. Deteriorated floor supports or floor supports insufficient to carry imposed loads with safety.

c. Members of walls, or other vertical supports that split, lean, list, or buckle due to defective material or deterioration.

d. Members of walls or other vertical supports that are insufficient to carry imposed loads with safety.

e. Members of ceilings, roofs, ceilings and roof supports, or other horizontal members which sag, split, or buckle due to defective material or deterioration.

f. Members of ceilings, roofs, ceiling and roof supports, or other horizontal members that are insufficient to carry imposed loads with safety.

g. Fireplaces or chimneys which list, bulge, or settle due to defective material or deterioration.

h. Any fault, defect, or condition in the building which renders the same structurally unsafe or not properly watertight.

3. Action by the City or Fire Marshall relative to the safety or physical condition of any person.

C. If the Staff finds a property is being demolished by neglect, and the Commission concurs with Staff's finding, Staff will initiate the enforcement proceedings found in Section 2-106.

SECTION 2 - 108 NON-CONFORMING USES OF LAND AND STRUCTURES

A. Purpose

The purpose of this section is to establish regulations and limitations on the existence of uses and structures which were established prior to the effective date of this Rule and which do not conform to the provisions of this Rule. Such non-conformities may continue, but the provisions of this section are designed to curtail enlargement or expansions of such non-conformities and to encourage their eventual elimination, in order to preserve the integrity of the Capitol Zoning District and the regulations established by this Rule.

B. Uses of Land

1. Authority to Continue

Any lawfully existing non-conforming use of part or all of a structure, or any lawfully existing non-conforming use of land not involving a structure or involving a structure which is accessory to such use of land, may be continued, so long as it remains otherwise in conformance with the provisions of this section.

2. Ordinary Repair and Maintenance

Normal maintenance and incidental repairs or replacement, and installation or relocation of walls, partitions, fixtures, wiring or plumbing, may be performed on any structure that is devoted in whole or in part to a non-conforming use; provided, however, that this shall not be deemed to authorize any violation of the other subsections of this article.

3. Addition or Extension

A non-conforming use of land shall not be extended, expanded, enlarged or increased. Such activity shall include, but shall not be limited to:

a. Extension of such use to any structure or land area other than that occupied by such non-conforming use on the effective date of this Rule, or any amendment hereto which causes such use to become non-conforming.

b. Extension of such uses within a building or other structure or any portion of the floor area that was not occupied by such non-conforming use on the effective date of this Rule, or an amendment hereto which causes such to become nonconforming.

4. Relocations

No structure that is devoted in whole or in part to a non-conforming use shall be relocated in whole or in part to any other location on the same or any other lot, unless the entire structure and the use thereof shall thereafter conform to all the regulations of the zone in which such structure and use are located after being so relocated. No non-conforming use of land shall be relocated in whole or in part to any other location on the same or any other lot, unless such use shall thereafter conform to all regulations of the zone in which such use of land is located after being so relocated.

5. Change in Use

Existing lawful use of land which does not conform to the provisions of this Rule at the date of adoption may continue. In no case shall a change from one non-conforming use group to another non-conforming use group, or change from one use to another within the same use group be allowed nor permitted by the Capitol Zoning District Commission.

6. Abandonment or Discontinuance

When a non-conforming use of land or a non-conforming use of part or all of a structure is discontinued or abandoned for a period of 180 consecutive days (regardless of any reservation of an intent not to abandon and to resume such use), such use shall not thereafter be reestablished or resumed. Any subsequent use or occupancy of such land or structure shall comply with the regulations of the zone in which such land or structure is located.

C. Structures

1. Authority to Continue

Any non-conforming structure which is devoted to a use which is permitted in the zone in which such structure is located may be continued so long as it remains otherwise lawful, subject to the provisions of this section.

2. Damage or Destruction

In the event that any structure that is devoted in whole or in part to a non-conforming use or which is not in conformance with the CZD Design Guidelines is destroyed by fire, explosion or other casualty, or the public enemy, to the extent of more than fifty percent (50%) of the current replacement value immediately prior to such damage, such structure and use thereof shall thereafter conform to all regulations of the zone in which such structure and use are located. When such damage or destruction is fifty percent (50%) or less of the reasonable replacement value of the structure immediately prior to such damage, such structure may be repaired and reconstructed and used for the same purposes as it was before the damage or destruction; provided that such repair or reconstruction is commenced within six (6) months and completed within twelve (12) months of the date of such damage or destruction. In extenuating circumstances, the Capitol Zoning District Commission may grant an extension of that time period.

3. Relocation

No non-conforming structure shall be relocated in whole or in part to any other location on the same or any other lot unless the entire structure shall thereafter conform to the regulations of the zone in which such structure is located after being relocated.

4. Structural Alterations

A non-conforming building shall be structurally added to, reconstructed or extended only under the following conditions:

- a.** The use to which said building is put conforms to the zone in which it is located.
- b.** Any accessory building located on the lot conforms to all requirements of the Capitol Zoning District Commission and the Little Rock Building Code.
- c.** The total lot area occupied by a building after the erection, conversion, reconstruction or structural alteration and the lot area occupied by existing encroachments, extensions or the projections into a required yard space shall not exceed the total area allowed by this Rule for new construction.
- d.** No part of the existing non-conforming building shall encroach, extend or project into more than forty percent (40%) of any one side yard distance required by this article.

- e. No part of the existing non-conforming building shall encroach, extend or project into more than thirty percent (30%) of either the front or rear yard distance required by this article.
- f. No part of the existing non-conforming building shall encroach, extend or project into more than one yard (front, side or rear) space distance required by this article.
- g. All erection, conversion, reconstruction or structural alteration shall fully conform to the yard space and all other applicable provisions of this article required for new construction.

SECTION 2 - 109 APPEALS

A. Any person aggrieved by actions of the Capitol Zoning District Commission staff in the administration of this Rule, may appeal within a reasonable time such action to the Commission for reconsideration. Such appeal shall be made by filing with the Director a written notice of appeal specifying the grounds thereof.

1. The Commission shall hear, at a time no later than the regular meeting following its next scheduled regular meeting, appeals from the following parties if filed within ten (10) business days of the action being appealed:

- a. the applicant or petitioner of the matter in question, or
- b. the owner of a property within 200 feet of the property in question.

2. The Commission may also consider, on a case-by-case basis, appeals made by other parties, and/or those filed after ten (10) business days of the action being appealed. To establish standing, any such appellants must demonstrate to the Commission's satisfaction why the appellant is substantively aggrieved by the action being appealed.

- a. If the Commission agrees to grant standing and hear such an appeal, it shall fix a reasonable time for the hearing of the appeal.
- b. If the Commission declines to hear such an appeal, it shall notify the appellant of its reasons for not hearing the appeal.

B. Appeals for reconsideration of staff decisions shall be conducted as administrative adjudications, as contemplated by the Arkansas Administrative Procedures Act (Act 434 of 1967, as amended), and shall follow such requirements as established therein.

1. All the materials constituting the record regarding the action being appealed shall be provided by the Director. The Commission shall give due notice to the affected parties, and shall decide, within a reasonable time, whether to affirm, amend, or reverse the action being appealed.

2. A pending adjudication stays all proceedings in the furtherance of the action appealed from, unless the Capitol Zoning District Commission determines that, on the basis of available facts, a stay would cause peril to life or property.

C. Any person aggrieved by any rule, regulation, order or decision of the Capitol Zoning District Commission, or of any decision by staff that the Commission has declined to review, made on or after July 1, 2016 may appeal the action to the Director of the Department of Arkansas Heritage, as set forth in A.C.A. 22-3-310, as amended. The appeal shall be made in writing within 30 days of the action in question and shall state the reason for the appeal. All appeals should be mailed via certified mail to: Director, Department of Arkansas Heritage, 1100 North Street, Little Rock, AR 72201.

1. The Director of the Department of Arkansas Heritage shall notify the Commission within 10 business days of such an appeal.

2. Within 10 business days from receipt of such notice, the Director of the Capitol Zoning District Commission shall provide a record of all proceedings concerning the action including a copy of all materials constituting the administrative record to the Director of the Department of Arkansas Heritage.

3. The Director of the Department of Arkansas Heritage shall overturn the decision of the Commission upon a finding that the Commission's decision is clearly erroneous.

4. Within 60 days of receipt of the record, the Director of the Department of Arkansas Heritage shall notify in writing the appellant and the Commission of his or her decision.

D. The decision of the Director of the Department of Arkansas Heritage may be appealed to the Circuit Court of Pulaski County, under the procedures established by the Arkansas Administrative Procedures Act. The Circuit Court shall review the appeal of the Director's decision *de novo*.

SECTION 2-110 AMENDMENTS TO THE CAPITOL ZONING DISTRICT MASTER PLAN & RULE

Amendments to the Capitol Zoning District Master Plan and the Capitol Zoning District Rule shall require compliance with the Arkansas Administrative Procedures Act (Act 434 of 1967, as amended).

ARTICLE THREE
GENERAL STANDARDS

SECTION 3- 101 PURPOSE & APPLICABILITY

Change is a sign of economic health and confidence in Little Rock's future. It is an essential process in a vital community, representing the current phase of an evolution that has been continuing since the beginning of the city. How we construct, where we build, and how we treat what is already established will determine the quality of life we provide for current and future generations. However, the character of change must be managed to assure that the heritage of Arkansas as represented in these special areas surrounding the State Capitol and Governor’s Mansion is protected and that the urban framework will support and enhance the quality of life for residents and visitors.

Historic buildings should be treated with respect, and additions and other new buildings should strengthen the design context. If the imprint of new construction is to be positive, thoughtful consideration must be given to each change in the built fabric of the community. Uncontrolled demolition, alteration and insensitive new construction can irreparably alter the character of the area. Once lost, the ambience of the Mansion and Capitol Areas cannot be recaptured with any sense of authenticity. These standards therefore are intended to guide the character of change such that the citizens of Arkansas will derive the maximum benefit of the Capitol and Mansion Areas and their environs.

This article contains prescriptive standards for development within the Capitol Zoning District, including allowable uses, building dimensions, parking, and signs. These standards apply to all properties within the jurisdiction of the Capitol Zoning District Commission.

SECTION 3- 201 ZONING REQUIREMENTS

This section contains the requirements for each zone in the Capitol Zoning District, as shown on the maps in Section 3-204. *The letter “Z” precedes each of the standards in this section and the next to indicate they are zoning requirements.*

Z1. Zone A “State Capitol Foreground”

Capitol Avenue should develop as the state’s principal ceremonial thoroughfare, linking the State Capitol with downtown Little Rock. This area should develop as a professional office center with supporting commercial uses. Medium-scale offices should be the predominant building type, with taller structures allowed on Capitol Avenue.

1. Setbacks

- Front, across any street from the State Capitol complex = minimum 25 feet, landscaped, no parking
- Front, fourth & fifth stories on Capitol Avenue = minimum 50 feet, landscaped, no parking
- Front, all other properties = maximum 25feet, landscaped, no parking
- Rear, structures designed for residential use = minimum 25 feet
- Rear, all other properties = no required minimum or maximum
- Side, detached residential-style structures = minimum 5 feet
- Side, all other properties = no required minimum or maximum

2. Ground coverage ratios

- Lot area per dwelling unit = minimum 1,200 square feet
- Enclosed floor to lot area = maximum 2.5 : 1.0

3. Building heights

- Properties adjoining Capitol Avenue, with review = maximum 5 stories or 75 feet (whichever is less)
- All other properties = maximum 3 stories or 45 feet (whichever is less)

4. Permitted uses

- Allowed by right = Residential 2, Office 1 - 2, Commercial 1
- Allowed with Commission review (conditional uses) = Residential 1, Civic 1- 3, Commercial 2 - 4

Z2. Zone B “Capitol Area Residential”

This zone encompasses what remains of the early neighborhoods that once surrounded the State Capitol. It allows for some light commercial and office uses, but the predominant building form should continue to be residential.

1. Setbacks

Front, all properties	= minimum 25 feet, landscaped, no parking
Side, all properties	= minimum 5 feet
Rear, all properties	= minimum 25 feet

2. Ground coverage ratios

Lot area per dwelling unit	= minimum 1,200 square feet
Enclosed floor to lot area	= maximum 1.5 : 1.0

3. Building heights

All properties	= maximum 3 stories or 45 feet (whichever is less)
----------------	----------------------------------------------------

4. Permitted uses

Allowed by right	= Residential 1, Office 1 - 2, Commercial 1
Allowed with Commission review (conditional uses)	= Residential 2-3, Civic 1- 3

Z3. Zone C “Union Station Mixed Use”

The blocks surrounding Union Station should develop as a broad mix of residential, office, and commercial uses and building forms.

1. Setbacks

Front, structures designed for residential use	= minimum 10 feet, landscaped, no parking
Front, across any street from the State Capitol complex	= minimum 25 feet, landscaped, no parking
Front, all other properties	= build to sidewalk
Rear, structures designed for residential use	= minimum 5 feet
Rear, all other properties	= no required minimum or maximum
Side, detached residential-style structures	= minimum 5 feet
Side, all other properties	= no required minimum or maximum

2. Ground coverage ratios

Lot area per dwelling unit	= minimum 1,200 square feet
Enclosed floor to lot area	= maximum 2.5 : 1.0

3. Building height

Properties with 10%+ slopes, with review	= maximum 5 stories or 75 feet (whichever is less)
All other properties	= maximum 3 stories or 45 feet (whichever is less)

4. Permitted uses

Allowed by right	= Residential 1- 2, Office 1 - 2, Commercial 1 - 3
Allowed with Commission review (conditional uses)	= Residential 3, Civic 1- 3, Commercial 4

Z4. Zone D “Interstate Industrial”

The area is isolated from other neighborhoods, and access is limited. Large, low warehouses are the predominant building form.

1. Setbacks

Front, all properties	= minimum 25 feet, landscaped, no parking
Rear, all properties	= minimum 25 feet
Side, all properties	= minimum 5 feet

2. Ground coverage ratios

Lot area per dwelling unit = n/a (residential uses not allowed in this zone)
Enclosed floor to lot area = maximum 1.1 : 1.0

3. Building height

All properties = maximum 3 stories or 45 feet (whichever is less)

4. Permitted uses

Allowed by right = Office 1 - 2, Commercial 1- 4, Industrial 1
Allowed with Commission review (conditional uses) = Civic 1- 3

Z5. Zone E “State Capitol Complex”

This zone is comprised entirely of state-owned property and is excluded from the Capitol Zoning District Commission’s jurisdiction (see A.C.A. 22-2-220 and Section 1-202 of this Rule).

Z6. Zone M “Mansion Area Residential”

This zone, comprising most of the Governor’s Mansion Area, allows for the continuation of traditional neighborhood residential development patterns. Single-family residences should be the predominant, though not the exclusive, land use and building form in this zone.

1. Setbacks

Front, where historic precedent exists on the block = minimum 15 feet, landscaped, no parking
Front, all other properties = minimum 25 feet, landscaped, no parking
Rear, all properties = minimum 25 feet
Side, all properties = minimum 10% of lot’s average width, but never less than 5 feet from an adjoining property

2. Ground coverage ratios

Lot area per dwelling unit, by right = minimum 2,500 square feet
Lot area per dwelling unit, with Commission review = minimum 1,200 square feet
Enclosed floor to lot area = maximum 1.1 : 1.0

3. Building height

All properties = maximum 2.5 stories or 35 feet (whichever is less)

4. Permitted uses

Allowed by right = Residential 1
Allowed with Commission review (conditional uses) = Residential 2, Civic 1- 2
Allowed with Commission review (conditional uses) = Office 1- 2, Commercial 1 (when located in a historic civic or commercial building)

Z7. Zone N “Neighborhood Commercial”

This hybrid zone allows for some light commercial and office uses in a traditional neighborhood context, but the predominant building form should remain residential. Commercial style structures may be allowed on corner lots.

1. Setbacks

Front, where historic precedent exists on the block = minimum 15 feet, landscaped, no parking
Front, all other residential style properties = minimum 25 feet, landscaped, no parking
Front, all other commercial style properties = maximum 0 feet (build to sidewalk)
Rear, all properties = minimum 25 feet
Side, all residential style properties = minimum 10% of lot’s average width, but never less than 5 feet from an adjoining property
Side, all commercial style properties = same as residential above, but with maximum of 5 feet on the side facing the adjoining street.

2. Ground coverage ratios

Lot area per dwelling unit, by right	= minimum 2,500 square feet
Lot area per dwelling unit, with Commission review	= minimum 1,200 square feet
Enclosed floor to lot area	= maximum 1.5 : 1.0
Floor area for commercial style properties	= maximum 2,000 square feet per floor

3. Building height and width

All residential style properties height	= maximum 3 stories or 45 feet (whichever is less)
All commercial style properties height	= maximum 2.5 stories or 35 feet (whichever is less)
All commercial style properties width	= maximum 30 feet on front facade

4. Permitted uses

Allowed by right	= Residential 1, Office 1
Allowed with Commission review (conditional uses)	= Residential 2, Office 2, Commercial 1, Civic 1- 2
Allowed with Commission review (conditional uses)	= Commercial 2 (when located in a historic civic or commercial building); Residential 3 (when not located in a historic single-family structure or duplex)

Z8. Zone O “General Commercial”

This zone allows for a broad mix of urban residential and business uses. Commercial-style buildings with traditional storefronts should be the predominant building form.

1. Setbacks

Front, all properties	= maximum 0 feet (mandatory build to sidewalk)
Rear, all properties	= maximum 5 feet
Side, all properties	= maximum 5 feet

2. Ground coverage ratios

Lot area per dwelling unit	= minimum 1,200 square feet
Enclosed floor to lot area	= maximum 1.5 : 1.0

3. Building height

All properties	= maximum 3 stories or 45 feet (whichever is less)
----------------	----------------------------------------------------

4. Permitted uses

Allowed by right	= Residential 1, Office 1, Commercial 1
Allowed with Commission review (conditional uses)	= Residential 2, Office 2, Commercial 2-3, Civic 1- 3
Allowed with Commission review (conditional uses)	= Residential 3 (when not located in a historic single-family structure or duplex)

SECTION 3- 202 ADDITIONAL ZONING REQUIREMENTS AND DEFINITIONS

The items in this section apply to all properties within the Capitol Zoning District unless clearly indicated otherwise. *The letter “Z” precedes each of the standards in this section, continuing the sequence from the previous section, to indicate they are zoning requirements.*

Z9. Accessory uses and structures are allowed by right.

1. An accessory use is a use located upon the same parcel as an allowed principal use which is clearly secondary and incidental to the principal use.

a. The most common accessory uses are storage and parking.

b. Accessory commercial uses include side businesses or services which do not change the overall character of the primary business, such as a limited-service bank branch within a grocery store, or a car wash at a fuel station.

c. Accessory civic uses may include a wide-range of activities related to a property's primary civic use, such as a church-sponsored soup kitchen, a college dormitory, or a concert series in a public park.

d. Typical residential accessory uses include, but are not limited to, children's playhouses, greenhouses, swimming pools, ball courts, etc.

e. Home Occupations in compliance with these Rules are also allowed as accessory uses to residential principal uses. Home occupations are income-producing activities conducted entirely within a dwelling or an accessory building and carried on by the resident(s) thereof, which are clearly incidental and secondary to the use of the dwelling for dwelling purposes and do not change the character of the dwelling nor the neighborhood,

i. A home occupation shall have no display, no stock-in-trade, no outside storage of equipment, and no commodity sold upon the premises. There shall be not more than three (3) persons engaged in such an occupation, at least one (1) of which must be occupant resident of the dwelling.

ii. A maximum of one home occupation per dwelling unit shall be allowed by right. Additional home occupations will be considered conditional uses, and will be considered by the Commission on an individual basis.

iii. The Capitol Zoning District Commission shall have final authority in determining the particular uses that may be defined as Home Occupations.

2. An accessory structure is a structure built or operated in conjunction with an accessory use, located on the same parcel of land as a principal structure containing the principal use. Accessory Structures must comply with the following requirements:

a. An accessory building or structure may occupy not more than thirty percent of the required rear yard.

b. All single and two family residences shall be separated from accessory structures by a distance of not less than six (6) feet.

c. No accessory building or structure shall be allowed in the front yard setback but in the side or rear yard, they shall maintain at least a three (3) foot setback from any property line. Where said rear yard abuts a dedicated alley, no setback shall be required from said alley.

Z10. Adult uses are prohibited in the Capitol Zoning District. Adult uses include, as defined herein, an Adult Bookstore, Adult Paraphernalia Store, Adult Motion Picture Theatre Establishment, or an Establishment Which Displays Live Nudity, or any other business or establishment characterized by an emphasis depicting, describing or related to sexual conduct or sexual excitement for prurient purposes. Uses which combine any or all of the uses listed above shall constitute an Adult Use if the floor area or inventory stock items cumulatively amount to more than ten percent (10%) of the establishment's total floor area or inventory stock.

1. An adult bookstore is an establishment having as a substantial or significant portion of its stock in trade, books, magazines, and other material, which are distinguished or characterized by their emphasis depicting, describing or relating to sexual conduct or sexual excitement for prurient purposes. For purposes of this paragraph, "substantial or significant portion of stock" shall mean more than ten percent (10%) of the subject establishment's inventory stock, or more than ten percent (10%) of subject premise's gross floor area.

2. An adult paraphernalia store is an establishment having as a substantial or significant portion of its stock devices, objects, tools, or toys, excluding clothing, which are distinguished by their association with sexual activity for prurient purposes, including sexual conduct or sexual excitement. For purposes of this paragraph, "substantial or significant portion of stock" shall mean more than ten percent (10%) of the subject establishment's inventory stock, or more than ten percent (10%) of subject premise's gross floor area.

3. An adult motion picture theatre is an enclosed building used for presenting material motion picture films, video cassettes, cable television, slides or any other such visual material distinguished by an emphasis on matter depicting, describing, or relating to sexual conduct or sexual excitement for prurient purposes, and to which minors under the age of 18 would not be admitted according to the system of ratings put forward by the Motion Picture Association of America.

4. An adult video store is an establishment having a substantial or significant portion of its stock in trade for sale or rent, movies, videos, and similar audio/visual media, which are distinguished or characterized by their emphasis depicting, describing, or relating to sexual conduct or sexual excitement for prurient purposes, or which, if exhibited for theatrical release, to which minors under the age of 18 would not be admitted according to the system of ratings put forward by the Motion Picture Association of America. For purposes of this paragraph, "substantial or significant portion of stock" shall mean more than ten percent (10%) of the subject establishment's inventory stock, or more than ten percent (10%) of subject premise's gross floor area.

5. An establishment which displays live nudity is an establishment which provides live entertainment for its patrons, which includes the display of nudity, including full frontal or rear nudity, or both, or the display for the primary or secondary genitalia of either sex for prurient purposes.

Z11. General industrial uses are prohibited in the Capitol Zoning District. General industrial uses include factories, power plants, petroleum or chemical refineries, saw mills, paper mills, slaughterhouses, wastewater treatment facilities, dumps or landfills, equipment or durable goods manufacturing, or any other industrial uses not listed under the use group "Light Industrial".

Z12. Building Height The height permitted, without additional review, within the Capitol Zoning District shall be forty-five feet (45'), except in Zone "M" where the maximum height is thirty-five feet (35').

1. The height of a building is determined by the highest vertical distance obtained under any roof element. Said vertical distance shall be measured from the highest point of the coping of a flat roof, or from the highest point of a mansard roof, or from the mean elevation between the ridge and eave of the gable of a sloped roof to the median elevation of a point on the final grade five feet (5') away from the foundation, or to a reference datum of the natural grade prior to site disruption for construction, whichever yields a greater dimension.

2. Exceptions to the permitted height shall only occur as approved by the CZDC using the height review procedures described below. Under no circumstances shall a structure exceed seventy five feet (75') as measured using the procedure defined in (1) above.

3. Buildings which are constructed under the permitted height of the District may have no more than three (3) stories or portions thereof above grade, except in Zone "M" where buildings may have no more than two and one-half (2½) stories above grade.

a. Buildings allowed, through height review, to exceed the permitted height, may have no more than five (5) stories or portions thereof above grade.

b. Appurtenances which meet the definition and requirements of "Appurtenances" below may exceed the height limit on new structures, with Commission review.

4. No addition to that portion of a building exceeding the seventy-five foot (75') maximum height limitation is allowed for structures which are made non-conforming by these Rules as to height. (Appurtenances which meet the definition and requirements of "Appurtenances" below may exceed the seventy five foot height limit, with Commission review, on such structures.).

5. There shall be no increase in the highest point of the floor area of buildings greater than the thirty-five foot (35') permitted height, but less than the seventy-five foot (75') maximum, unless approved by the Commission as described below. (Appurtenances which meet the definition and requirements of "Appurtenances" below may, with Commission review, exceed the permitted height on any such structures made non-conforming by these rules.)

6. Building height may be increased by up to thirty feet (30') in Zones A and C upon a finding by the CZDC that the proposed height is in conformance with the provisions of this section and the Design Standards for the Capitol Area.

a. In Zone A, along Capitol Avenue, in order to protect the view of the State Capitol Building and Dome, any additions to the permitted height must be set back fifty feet (50') from the Capitol Avenue right-of-way. **See Figure 1, at the end of this section.**

b. On slopes greater than ten percent (10%) in Zone C, the building height may exceed the permitted height, but under no circumstances shall a structure exceed seventy-five feet (75') or five stories on any façade. For the purposes of calculating the slope of a site for a height exception, the slope shall be the median slope as calculated along the long axis of a parcel. **See Figure 2, at the end of this section.**

7. Building appurtenances are architectural or mechanical features located above the roof level and not used for human occupancy, including, but not limited to, spires, belfries, cupolas or dormers, parapet walls, cornices, HVAC equipment, chimneys, ventilators, skylights, antennas, microwave dishes, and solar systems

Appurtenances may be added under the following circumstances:

a. The addition of an appurtenance to a building is permitted by right if it does not cause building height to exceed the height allowed in this section, considering, for this purpose only, the uppermost point of the appurtenance to be the uppermost point of the roof.

b. The CZDC may approve additions of appurtenances to buildings causing a building height to exceed the maximum permitted height if ALL the following standards are met:

i. There is a functional need for the appurtenance that cannot be met with an appurtenance at a lesser height; and

ii. Visible materials and colors are compatible with the building to which the appurtenance is attached; and

iii. All appurtenances are consistent with any applicable Design Standards.

c. In no circumstance shall an appurtenance or appurtenances:

i. have usable a floor area, except as needed for mechanical equipment installations; or

ii. cover more than twenty-five percent (25%) of the roof area of the building; or

iii. be more than sixteen feet (16') in height.

d. All appurtenances consisting of mechanical equipment shall be screened from view, regardless of the height of the building, unless it is demonstrated to the satisfaction of the CZDC such screening would conflict with the function of the mechanical equipment. The CZDC will determine if the screening of the equipment is adequate based on the following criteria:

i. Screening is consistent with the building design, colors, and materials;

ii. Screening placed on the portion of the roof which is least visible from adjacent streets and properties;

iii. Screening is consistent with any applicable Design or Rehabilitation Standards;

- iv. The height of the screen is the minimum appropriate to adequately screen the mechanical equipment; and
- v. Screening does not increase the apparent height of the walls of the building. The use of parapet walls to screen mechanical equipment is discouraged. The height of parapet walls should be the minimum necessary to screen mechanical equipment.

Z13. Dwelling Units A dwelling unit is any room or group of rooms within an enclosed structure and forming a single habitable unit with facilities which are used or intended to be used for living, sleeping, bathing, cooking and eating, whether or not such unit is occupied or vacant.

- 1. Any dwelling unit occupied by any group of individuals other than a family shall be construed as a rooming house, shelter, group home, or other communal living facility. (See U.6 in Section 3-203.)
- 2. A family is:
 - a. an individual or two or more persons related by blood, marriage, adoption, or other verifiable familial relationship living together as a common household; or
 - b. a group of no more than four persons unrelated by blood, marriage, adoption, or other verifiable familial relationship living together as a common household; or
 - c. a group of not more than six unrelated disabled persons, as contemplated by applicable state and federal law, along with up to two additional persons, acting as supervisors or guardians (who need not be related to each other, nor to any of the disabled persons in the group), living together as a common household, but with no persons receiving ongoing medical or nursing care on the property; or
 - d. a group of not more than four unrelated disabled persons, as contemplated by applicable state and federal law, with one or more receiving ongoing medical or nursing care on the property, along with up to two additional persons, acting as supervisors or guardians (who need not be related to each other, nor to any of the disabled persons in the group), living together as a common household.
- 3. Group living facilities are generally inappropriate uses in the Mansion Area. To accommodate disabled persons, however, whose disability or disabilities call for living in a larger group than those described in items **b.** & **c.**, above, the Commission will consider applications for Conditional Use Permits for group living facilities on a case-by-case basis.
 - a. The Commission will approve a proposal for a group living facility in the Mansion Area if it is:
 - i. Located in Zone N or Zone O; and
 - ii. Not located in a historic structure designed for single-family or two-family use; and
 - iii. Not located within 600 feet (measured from property line to property line) of another such facility; and
 - iv. Consistent with the requirements for parking and any other applicable review criteria.
 - b. The Commission may also approve for a group living facility in the Mansion Area that is not consistent with the above requirements, if it is demonstrated to the Commission's satisfaction that the proposal represents a reasonable accommodation for the disabled individuals.

Z14. Floor Area A building's enclosed floor area is the total square footage of all levels included within the outside walls of a building or portion thereof, but excluding courts and uninhabitable areas below the first floor level. A building's enclosed floor to lot area ratio is the ratio of the floor area of a building to the area of the parcel on which the building is situated, excluding structured parking, balconies, and decks.

Z15. Setback A setback is the required space or yard, unenclosed from its lowest portion to the sky, from the property line to the nearest finished vertical surface of the main structure, not including the ordinary projection of architectural elements such as chimneys, eaves, sills, cornices, steps, unenclosed walkways, or ornamental features.

1. The Commission, with review, may reduce a required setback by up to 25% in cases where a lot is smaller than what is typical for the Area, is not accessible from an alley, or is otherwise irregular due to its shape or platting. In extreme cases of lots 4,500 square feet or less in total area that were platted or subdivided prior to July 1, 2018, the Commission may reduce a required setback by up to 50%.
2. The front yard is that portion of a parcel which directly abuts a public street. In cases where a parcel is located on the corner of two intersecting streets, the narrowest portion of the lot contiguous to the public street will be defined as the front yard.

Z16. Food and Beverage Uses

1. A restaurant is an establishment with a sanitary kitchen and persons to prepare, cook and serve, in consideration of payment, meals and beverages to guests.
 - a. A microbrewery is an establishment that annually manufactures less than 50,000 gallons of alcoholic beverages for consumption primarily on site (75% or greater of beverages manufactured on site are consumed on site), and provides food preparation and service on site. Microbreweries shall be treated as restaurants for the purposes of these regulations.
 - b. A fast food restaurant is a restaurant, with minimal or no table service, that prepares food in bulk in advance, packaged to order, and ready to take away. A drive-in or drive-through restaurant is a fast food restaurant with service offered directly to persons in automobiles.
2. A tavern or bar is an establishment serving malt, vinous, and spirituous liquors in which the principal business is the sale of such beverages at retail for consumption on the premises.
3. A liquor store or package store is an establishment in which the principal business is retail sales of prepackaged malt, vinous, and spirituous liquors for consumption off the store's premises.
4. A grocery store is an establishment in which the principal business is retail sales of fresh and/or packaged food, generally intended for home consumption. A neighborhood grocery" means a retail establishment offering for sale a limited line of groceries and household items intended for convenience of the neighborhood, and not exceeding 12,000 square feet of floor area.

Z17. Structure A structure is any improvement placed on a property, permanently or semi-permanently attached or affixed to the ground, more than four feet tall and with a solid roof.

Z18. Wireless Communication Facilities

A wireless communication facility (WCF) is any unstaffed facility for the transmission or reception of wireless telecommunications services, usually consisting of an antenna array, connection cables, an equipment facility, and a support structure to achieve necessary elevation. Wireless Communications means any personal wireless service as defined in the Telecommunications Act of 1996, which includes FCC licensed commercial wireless telecommunications services including cellular, personal communication services (PCS), specialized mobile radio (SMR), enhanced specialized mobile radio (ESMR), paging, and similar services that currently exist or that may in the future be developed.

1. An attached WCF is an antenna array attached to an existing building, structure or associated new construction with any accompanying pole or device that attaches the antenna array to the building or structure and associated connection cables, and any equipment facility which may be located either inside or outside the attachment structure. Attached WCFs that meet each of the below criteria are allowed by right in all areas of the Capitol Zoning District. (Proposals for attached WCFs that do not meet each of the criteria below may also be considered by the Commission on a case by case basis.)

a. Stealth technology must be employed to conceal, camouflage and minimize the antenna arrays associated with the facility.

i. Antenna Array means one or more rods, panels, disks or similar devices used for the transmission or reception of radio frequency signals, which may include an omni-directional antenna (rod), a directional antenna (panel) and a parabolic antenna (disk).

ii. Stealth Technology means systems, components and materials used in the construction and design of attached WCF which are developed to mask or conceal the facility and antenna array to make them compatible with the structure they are attached to, the surrounding properties, and the neighborhood in general.

b. Attached WCFs shall not be artificially illuminated directly or indirectly, except as may be required by state or federal law and shall not display any signage, logos, decals, symbols or any messages of a commercial or noncommercial nature except for a small message containing provider identification and emergency telephone numbers.

c. Attached WCFs shall comply with all standards for height, setback, design, and any other applicable requirements as specified in these Rules,

2. Free standing, detached wireless communication facilities (WCF) consisting of, but not limited to, omni-directional antennas (rods), directional antennas (panels), and parabolic antennas (disks) supported by monopoles, towers, self-supporting (lattice) or guywire supported towers, or other similar structures are inappropriate installations in both the Governor's Mansion and Capitol areas.

3. Wireless Communications Facilities (either attached or free standing) in existence on January 1, 2017, which do not comply with the requirements of this amendment (nonconforming WCF) are subject to the following provisions:

a. Nonconforming WCF may continue in use for the purpose now used, but may not be expanded or change users without complying with this amendment.

b. Nonconforming WCF which become damaged or destroyed due to any reason or cause, may be repaired and restored to its former use, location, and physical dimensions provided the user does not change and the facility is not expanded.

c. Any nonconforming WCF that is not operated for a continuous period of twelve (12) months shall be considered abandoned, and the owner of such WCF shall remove same.

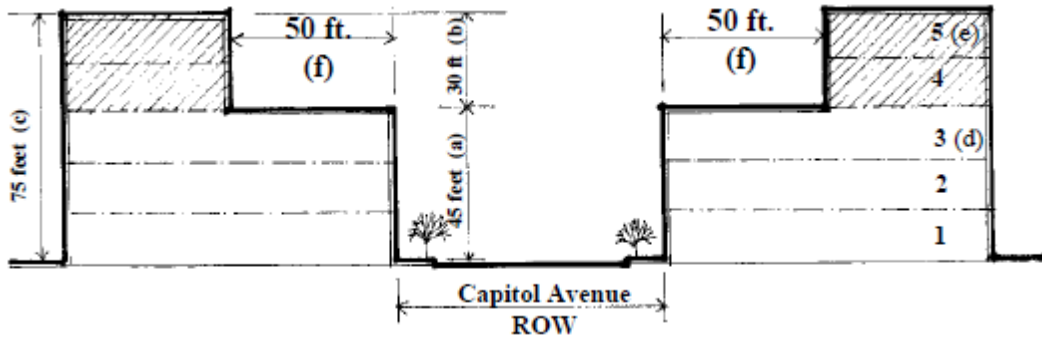

Figure 1. SETBACKS AT CAPITOL AVENUE

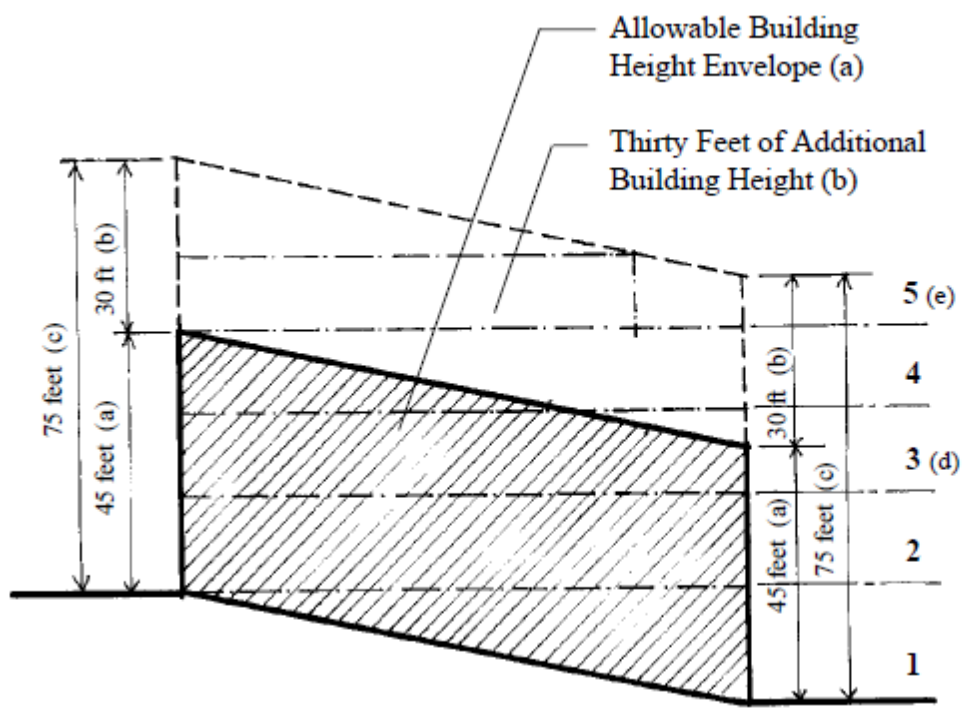

Figure 2. SLOPES GREATER THAN 10% in ZONE "C"

NOTES:

- (a) Permitted Height of forty-five (45) feet
- (b) Thirty (30) Feet of Additional Building Height (*allowed only in Zones A and C and only upon Height Review approval by the CZDC*)
- (c) Seventy-five (75) maximum height (*allowed only in Zones A and C and only upon Height Review approval by the CZDC*)
- (d) Buildings which are constructed under the permitted height may have no more than three (3) stories
- (e) Buildings allowed, through Height Review, to exceed the permitted height, but under no circumstances greater than seventy-five (75) feet, nor more than five (5) stories, on any façade.
- (f) Thirty (30) Feet of Additional Building Height, upon approvals outlined in Note (b) above, shall be set back fifty (50) feet from Capitol Avenue

SECTION 3- 203 USE GROUPS

The permitted uses of land within the Capitol Zoning District are listed herein by use groups, and these use groups are permitted only within the specific zones as indicated in Section 3-201 and within the limits of the zones as shown on the maps included in Section 3-204. *The letter “U” precedes each of the standards in this section to indicate they are use groups.*

U.1 CIVIC 1 (Unstaffed Facilities)

- Airway beacon or marker
- Bus passenger depot
- Civil Defense and related activities facility
- Electric regulating substation
- Electric utility mains and distribution facilities and apparatus
- Fire protection and related activities facilities
- Flood control works
- Gas pipeline right of way
- Gas pressure control station
- Petroleum pipeline or pressure control station
- Pipeline right of way or pressure control station, not elsewhere classified
- Railroad passenger terminal
- Railroad right of way (excluding switching and marshaling yards)
- Rapid rail transit or street railway right of way
- Rapid rail transit or street railway terminal
- Sewage pressure control station
- Taxicab stand or dispatching station
- Telephone exchange station, relay tower or r.o.w.
- Telegraph transmitting or receiving station or r.o.w.
- Television or radio transmitting station or relay tower
- Water pipeline r.o.w., treatment plant, storage facility or pressure control station

U.2 CIVIC 2 (Neighborhood Community Facilities)

- Church, Synagogue, or Temple, including Sunday School or other religious education facilities
- Community center (public)
- Library (private, non-profit and public)
- Museum or Art Gallery
- Nursery school, daycare, kindergarten
- Parish house, parsonage, rectory or manse
- Park, playground, playfield or tot lot (public)
- School, elementary (public or private)
- School, secondary (public or private)
- Fine Arts Studio:, Dance, Drama, Visual Arts, Music, etc.
- Swimming pool (public)
- Tennis courts (public)
- Theatrical group or community theatre
- Meeting or reception facility
- Tour home or house museum

U.3 CIVIC 3 (Regional Community Facilities)

- Club or lodge (private non-profit)
- Rehabilitation institution for substance abuse
- Hospital; general
- Hospital; restricted to mental, narcotics or alcoholic patients
- Mental institution, sanitarium
- Modeling school and studio
- Trade or vocational school, such as barber, beauty, real estate, clerical, etc. (but excluding manual training, shopwork, auto repair, or maintenance of machinery or mechanical equipment)
- Eleemosynary institution, philanthropic institution
- University, college, community college, junior college, or professional school; including satellite or extension facilities
- Zoological gardens (public)

U.4 RESIDENTIAL 1 (One and Two Family) *Uses in this group may have a maximum of one family per dwelling unit and two dwelling units per parcel.*

- Single family detached dwelling
- Duplex; including detached or semi-detached duplex
- Home occupation (max. 1 per dwelling unit)

U.5 RESIDENTIAL 2 (Multifamily) *Uses in this group may have a maximum of one family per dwelling unit.*

- Triplex, four-plex, five-plex, etc
- Apartment building
- Townhouse
- Apartment hotel
- Condominiums
- Home occupations (max. 1 per dwelling unit)
- Bed and breakfast house (max. of 5 guest rooms; exempt from 1 family/DU maximum)

U.6. RESIDENTIAL 3 (Group Living) *Uses in this group feature shared facilities for sleeping, bathing, and/or cooking.*

- Convalescent, maternity or nursing home
- Home for the elderly
- Home or shelter for battered women and/or children
- Fraternity or sorority house
- Boarding or rooming house
- Residential care or assisted living facility
- Shelter for homeless individuals

U.7 OFFICE 1 (Quiet Office) *All uses in this group are to operate in their entirety within a completely enclosed structure.*

- Artist's or photographer's studio (not including film processing for others)
- Broker, consumer goods (no inventory for sale on site)
- Collection agency (no repossessed items stored on site)
- Drafting service
- Insurance agency or office
- Medical clinic, including family practice, urgent care, optometry, dentistry, psychiatry, chiropractic or osteopathic medicine, etc.
- Political campaign headquarters
- Office of nonprofit membership association or union office
- Office a recognized professional practice, such as Accounting, Architecture, Law, Business consulting, , Private investigation, Engineering, Advertising, Public relations, , Graphic arts, Interior design, Landscape architecture , , Insurance, Financial planning, Stock brokerage, Real estate, etc

U.8 OFFICE 2 (General Office) *Every use in this group, shall be operated in its entirety within a completely enclosed structure.*

- Addressing, duplicating, mailing, mailing lists, stenographic, telephone messages, and similar office services
- Bailbond broker
- Blueprinting, photocopying and similar reproduction services
- Broadcasting or recording studio
- Computing, data processing, or similar service
- Employment service
- Engraving (except when in connection with printing)
- Financial institution, including banks and credit unions, but excluding pawn shops or payday lending
- Funeral establishment, ambulance and embalming service
- Office, not elsewhere classified
- Optical laboratory or supplies
- Sales, service, repair or rental of business machines including accounting, computing, and data processing machines, copying and office reproduction machines, dictating and recording machines, typewriters
- Store selling architects' artists', or engineers or scientific supplies and equipment or dental, medical or office supplies or equipment
- Post Office
- Police station, fire station, or emergency medical dispatch
- Courier or specialty transportation or delivery service

U.9 COMMERCIAL 1 (Quiet Retail)

Enclosure of uses required. Every use in this group, shall be operated in its entirety within a completely enclosed structure.

- Antique shop (not junk or second hand merchandise)
- Art shop (sales only)
- Artist supply stores
- Barber shop
- Beauty Shop
- Bed and Breakfast house (more than 5 guestrooms)
- Bookstore or newsstand
- Camera and photographic supply store
- Cigar or tobacco shop
- Clothing or accessories store
- Delicatessen, sandwich or coffee shop
- Gift shop
- Neighborhood Grocery ()
- Gym or fitness center (commercial)
- Health clubs, therapeutic massage and sauna
- Hobby shop
- Ice cream and candy store
- Interior decorator store
- Jewelry store
- Knit shop
- Leather goods or luggage store
- Music shop
- Newsstand
- Notions store
- Optical goods store
- Pet shop
- Plant or flower shop
- Pottery and ceramics store (sales only)
- Prescription pharmacy
- Religious goods store
- Restaurant (other than fast food)
- Shoe store (sales or repair shop)
- Specialty food and beverage (non-alcoholic) store
- Sporting goods store
- Stationery store
- Tailor shop
- Toy store
- Video rental store
- Watch or clock stores

U. 10 COMMERCIAL 2 (Consumer Goods and Services) *Enclosure of use required. Every use in this group shall be operated in its entirety within a completely enclosed structure.*

- Accessories for vehicles or equipment whose sale is permitted, but not including the rebuilding or recapping of tires
- Air conditioning units (portable)
- Amusement machines

- Automatic merchandising establishment (excluding amusements, games or music)
- Automobile parts store (no parts installation or attachment allowed on site)
- Awning shop and sales
- Bicycle store*
- Building materials store
- Building contractors; display rooms, offices and storage
- Burglar alarm systems
- Clothing; second hand*
- Coupon redemption store
- Department store
- Dry goods store
- Electrical supplies
- Exhibition house
- Fast Food restaurant
- Furniture, home furnishings, equipment and appliances*
- Garden equipment and furniture*
- Gasoline and motor oil sales only (does not include usual gasoline service station facilities)
- General store, general merchandise only*
- Glass or mirror store
- Greenhouse and botanical nursery
- Grocery store, including bakery (retail only)
- Hardware store*
- Heating equipment (sales, rental and repair)
- Household appliance store
- Lawnmower and small motor appliances
- Limited price variety store*
- Liquor store
- Lumber (retail sales)
- Mail order house (no stock)
- Meat or poultry shop (no live poultry)*
- Monuments, including incidental processing to order, (but not shaping)
- Orthopedic appliance store
- Paint, glass or wallpaper store*
- Plumbing equipment (sales, rental and repair)
- Pest or insect control
- Radio, television, phonograph, or other household electronics equipment store*
- Retail bakery with production on site*
- Rubber or metal stamp*
- Sewing machines stores, embroidery and hem stitching
- Aluminum recycling plant
- Animal hospital serving household pets and similar small animals, breeding, raising, or boarding of household pets or similar small animals for commercial purposes; kennel
- Archery range
- Auction house or store
- Cabinet maker

- Caterer*
- Custom dressmaker, milliner, or tailor*
- Delivery and express service
- Dry cleaning pick-up or self service
- Dry cleaning plant
- Fix it shop
- Fur repair and storage
- Gunsmith shop
- Household appliance repair shop
- Laundry pick-up or self service
- Novelties shop
- Pawn shop
- Payday lending
- Picture framing*
- Pressing, alteration or garment repair*
- Safe and vault repair
- Scientific instrument repairs
- Sign painting
- Taxidermist
- Telegraph company office
- Tool sharpening
- Upholsterer; furniture

** Uses in this group marked with an asterisk shall be treated as a quiet business when the total floor area of the business will be less than 4,000 square feet.*

U.11 COMMERCIAL 3 (Lodging and Amusement)

Enclosure of use required. Every use in this group shall be operated in its entirety within a completely enclosed structure, unless noted otherwise.

- Arena or auditorium; commercial
- Billiard or pool parlor
- Bowling alley
- Dance hall
- Eating places providing dancing or entertainment
- Hotel or motel
- Motion picture theatre
- Skating rink; commercial
- Swimming pool; commercial (exempted from enclosure)
- Tavern or bar, night club, or semi-private club*
- Tennis court; commercial (exempted from enclosure)
- Arcade

U. 12 COMMERCIAL 4 (Automobile Oriented Commercial)

Enclosure of uses required. Every use in this group, unless specifically exempted, shall be operated in its entirety within a completely enclosed structure.

- Automobile parking as a principal use (exempted from enclosure)
- Automobile body repair
- Automobile rental

- Automobile parking as a principal use (exempted from enclosure)
- Automobile body repair
- Automobile rental service
- Automobile repair and test station
- Automobile sales (exempted from enclosure)
- Automobile storage garage
- Automobile upholstery repair
- Automotive vocational training or school
- Automobile wash service (including self-service)
- Commercial parking lot (exempted from enclosure)
- Convenience store / Auto convenience market
- Drive-in restaurant (drive-in facilities exempted from enclosure)
- Driving school
- Gasoline service station (fuel pumps exempted from enclosure)
- Parking deck

U.13 COMMERCIAL 5 (Adult Uses)

These uses are not allowed in the Capitol Zoning District.

- Adult Bookstore
- Adult Paraphernalia Store
- Adult Motion Picture Theater
- Adult Video Store
- Establishment Which Displays Live Nudity

U. 14 INDUSTRIAL 1 (Light Industry)

- Assembly, production, fabrication
- Direct selling organization; retail
- Laboratory; research, development or testing
- Motion picture distribution and services
- Photofinishing service
- Printing, lithography, stamp mfg., and book binding
- Warehousing (not elsewhere classified) other than warehousing accessory to another permitted use
- Wholesale commercial brewery or distillery
- Wholesaling (not elsewhere classified) with stocks limited to floor samples
- News syndicate service

U.15. INDUSTRIAL 2 (General Industry) *These uses are not allowed in the Capitol Zoning District.*

- Any manufacturing or industrial use, not elsewhere classified

U.16 OTHER USES

1. For any use not listed in one of the above groups, the Commission or its staff shall determine on a case-by-case basis which Use Group the proposed use most closely resembles, following due consideration.

2. For mixed-use developments, the Commission will evaluate the proposal according to the development's primary or principal use. If no primary or principal use can be determined, the Commission or its staff will evaluate the proposal according to the most intense of all the uses proposed.

SECTION 3- 204 ZONING MAPS

A. State Capitol Area Zoning Map

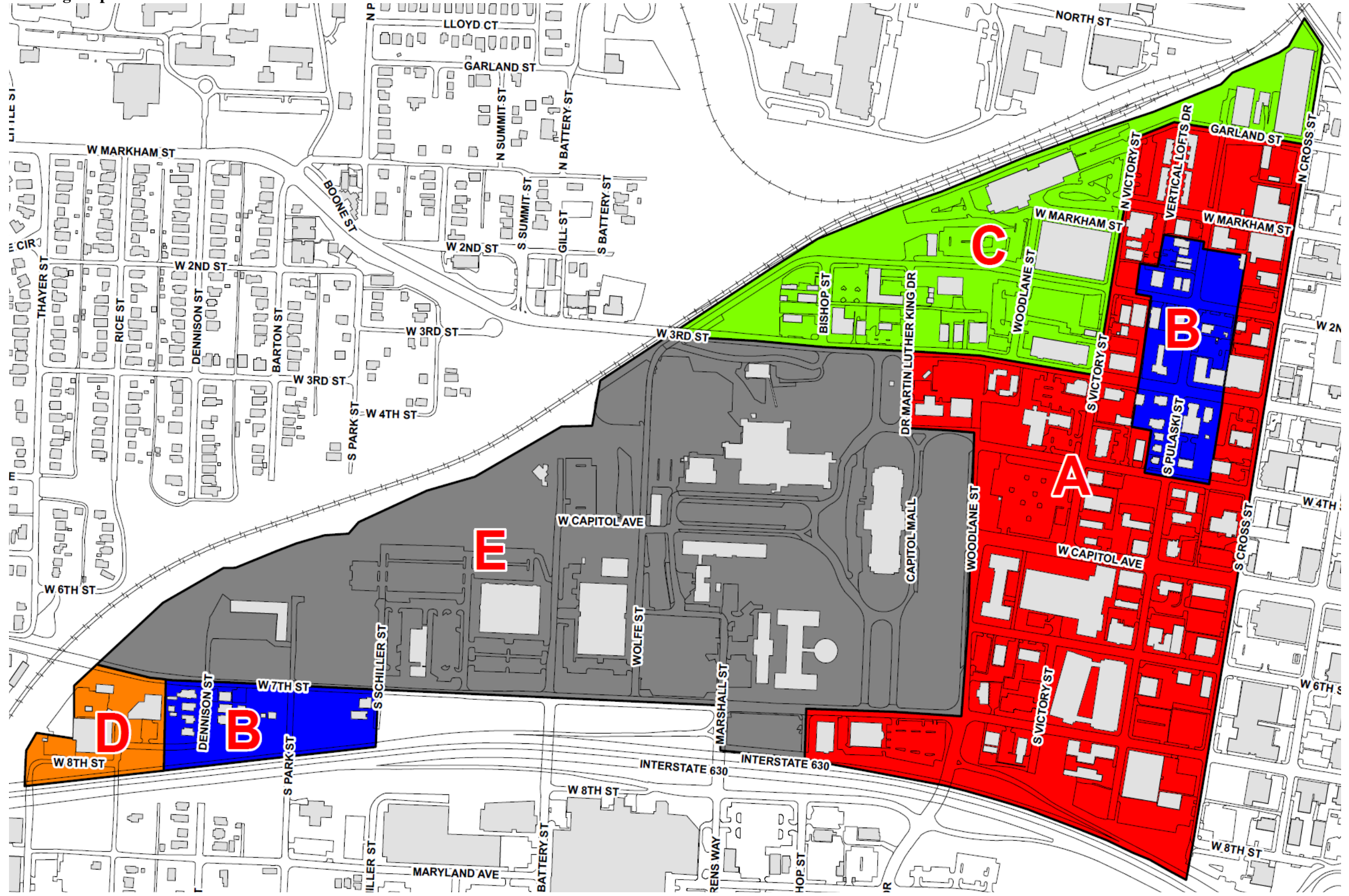

THIS PAGE INTENTIONALLY LEFT BLANK.

B. Governor's Mansion Area Zoning Map

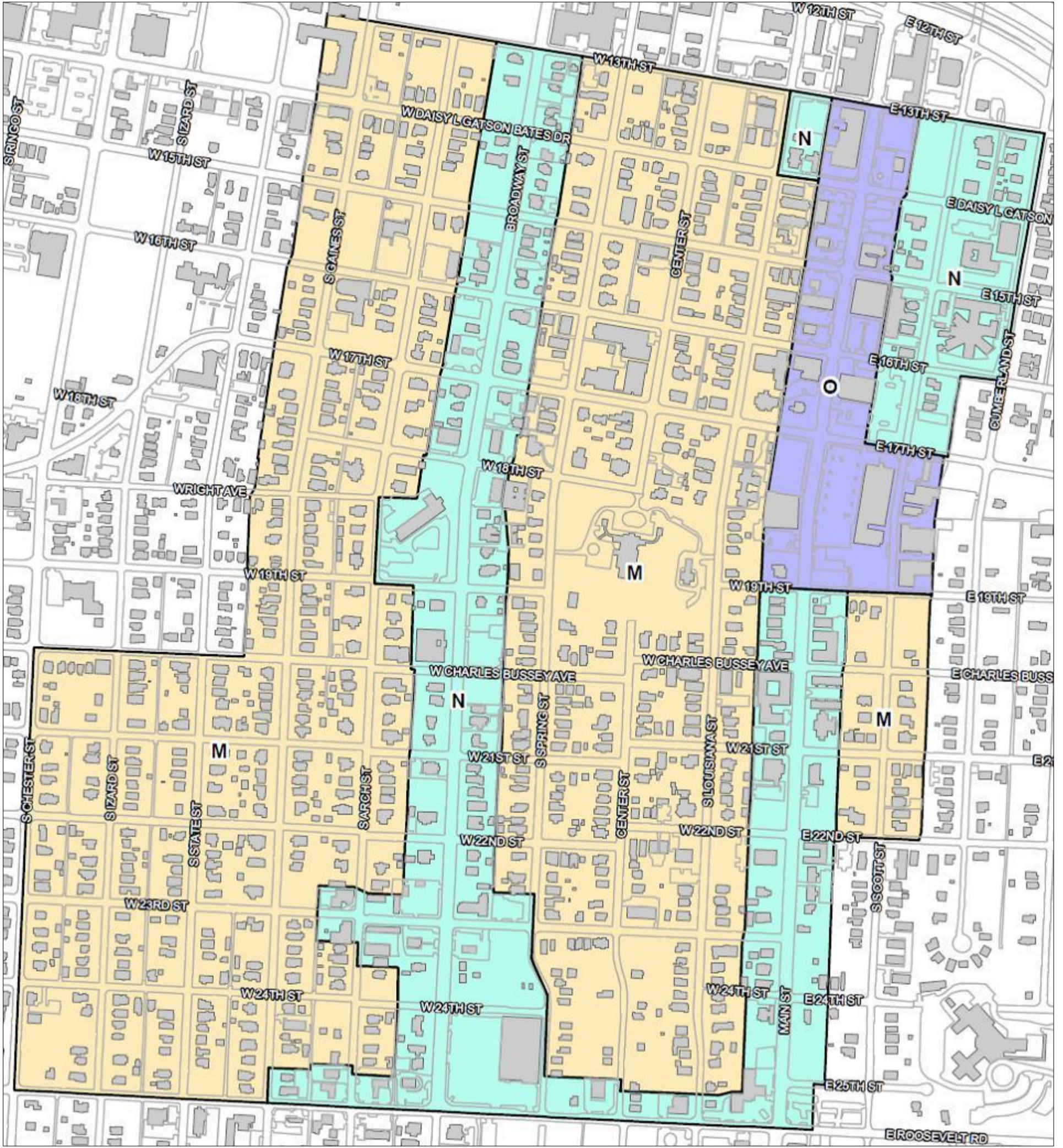

THIS PAGE INTENTIONALLY LEFT BLANK.

SECTION 3- 301 PARKING REQUIREMENTS *The letter "P" precedes each of the standards in this section to indicate they are parking requirements.*

P.1 Requirement

There shall be provided for each use in any zone the number of off street parking spaces required for that use as listed in Standard P.14, "Required Parking Spaces by Use", unless the number of parking spaces required by Standard P.14 is six (6) or fewer, in which case no off-street parking spaces shall be required.

P.2 Standing and Loading Space

On the same premises with every building hereafter erected or structurally altered and occupied by uses involving the receipt or distribution by commercial vehicles, there shall be provided and maintained adequate space for standing, loading and unloading in order to avoid undue interference with public use of the street or alley. The minimum off street loading space required shall include a loading space which measures twelve (12) feet by thirty (30) feet with a fourteen (14) foot height clearance for every 20,000 square feet of floor and land area involved in the use of the property. The first 20,000 gross square feet shall be exempt from the loading space requirement. This required off-street loading space shall be in addition to an area or means adequate for egress, ingress and maneuvering.

P.3 Combined Facilities

Off-street parking facilities required for two or more similar uses located on the same building site may be combined and used jointly, provided however that the total number of off-street parking spaces shall not be less than the sum of requirements for the various individual uses computed separately. If the number of parking spaces suggested by these regulations is six (6) or fewer for each use, then no parking spaces shall be required, even if the combined total is greater than six (6).

P4. Parking Reductions

1. A parking reduction of up to 50% of the required parking may be granted by staff in commercial zones A, C, D, and O if each of the following criteria is met:
 - a. The parking needs of the use or uses will be adequately served; and
 - b. If a mix of residential uses with either office or retail uses is proposed, the parking needs of all uses will be accommodated through shared parking; and
 - c. If joint use of common parking areas is proposed, varying time periods of use will accommodate proposed parking needs
2. The Commission may also approve a parking reduction up to 50% (for a total reduction of up to 100% in commercial zones A, C, D, and O) with review. In such reviews, the applicant must demonstrate to the Commission's satisfaction that:
 - a. The pattern and character of development in the vicinity is consistent with the request for reduced parking; and
 - b. The use is likely to attract residents, employees, and/or visitors who are likely to avail themselves of alternate modes of transportation.

P5. Use of Right-of-Way for Provision of Required Parking

The public street frontage immediately adjoining the parcel(s) containing a current or proposed use may be considered as fulfilling or partially fulfilling the parking requirements of this section.

P.6 Expansions

When a building or structure erected prior to or after the effective date of this document shall undergo any increase in number of dwelling units, gross floor area, seating capacity, number of employees, or other unit of measure used in determining required parking facilities, and when said increase would result in a requirement for additional parking facilities, such additional facilities shall be accordingly provided as a condition for obtaining a building permit or privilege license. In computing the number of spaces required for such a building, however, only the increase in unit of measure shall be considered.

P7. Location of Required Parking

1. For staff-level approval, all parking spaces provided pursuant to this section shall be on the same parcel with the building they serve or within three hundred (300) feet thereof; and

a. The distance to any off-site parking area (on a parcel or parcels other than that on which the building in question is located) shall be measured between the nearest point of the parking area or facility and the nearest public entrance of the building said parking area or facility is to serve; and

b. No off-site parking spaces shall be counted towards any required parking spaces for the disabled and;

c. Any proposed off-site parking does not comprise more than fifty percent (50%) of the total number of spaces required in this section; and

d. The right to use the proposed off-site parking area(s) is established by ownership, easement, or similarly executed covenant or agreement.

2. The Commission may approve an additional 25% (for a total of 75% off-site parking) with review; and/or the use of an employee parking area located up to 500 feet from the building served (using the measurement described in 1.a., (above)). In such cases, applicants for this additional and/or farther off-site parking must demonstrate to the Commission's satisfaction that

the request will not cause unreasonable hazard to pedestrian or vehicular traffic in the vicinity

P8. Pavement Requirements

1. Any portion of land which is changed to a parking or other vehicular use area shall be improved where subject to wheeled traffic.

a. Well-maintained gravel or chat surfaces are usually sufficient for parking areas of up to 20 spaces. Bricks or pavers are also appropriate for most residential parking areas.

b. For larger parking areas, pavement should comply with the U.S. Environmental Protection Agency's Best Management Practices for porous asphalt pavement, permeable interlocking concrete pavement, or pervious concrete pavement.

c. Proposals for traditional asphalt or concrete pavement in conjunction with multifamily or non-residential uses will be evaluated by the Commission on a case by case basis. (Staff may approve limited applications of traditional concrete pavement in association with single and two-family uses.)

2. Any land being paved to accommodate parking for a new use should not exceed 110% of the area required for parking and maneuvering (prior to applying any reductions or waivers). The Commission may allow an applicant to pave up to 150% of the area required if it is demonstrated to the Commission's satisfaction that:

a. The pattern and character of development in the vicinity is consistent with the request for additional parking; and

b. Paving the additional area will be sufficiently mitigated by the use of porous or semi-permeable paving systems, additional landscaping beyond the minimum required, or other innovative mitigation measures.

3. A proposal to pave an area larger than 150% of the minimum required for parking and maneuvering (prior to applying any reductions or waivers) will be considered a request for parking as the principle use for the entire parcel.

P.9 Parking Design for Standard Size Cars

The following four parking angles are allowed with their respective width and depth dimensions for stalls and maneuvering areas:

TYPE	WIDTH	DEPTH	MANEUVERING AREA
Parallel	22 ft.	9 ft.	11 ft.
Right Angle	9 ft.	20 ft.	20 ft.
60 Degree Angle	9 ft.	18 ft.	20 ft.
45 Degree Angle	9 ft.	18 ft.	16 ft.

P.10 Parking Spaces for the Disabled

The requirements for disabled and accessible parking set forth in the Little Rock Code of Ordinances, as it existed on the date of the most recent amendment to this Rule, shall be in full force and effect erecting, constructing, enlarging or otherwise altering or improving a vehicular use area.

P.11 Permanency of Spaces Provided

Any off-street parking or loading space established prior to the effective date of this document and which is used or intended to be used in connection with any main building, structure or use, or any spaces designed and intended to comply with the requirements of this document for any such main building or structure erected after such effective date, shall hereafter be maintained so long as said building or structure remains, unless the owner provides and maintains in another location an equivalent number of required spaces in conformance with the provisions of this document. Any conveyance of such parking or loading space, or transfer of interest therein, by the owner of the property served thereby without a simultaneous conveyance or transfer of the property served thereby to the same guarantee or transferee or without suitable provisions being made in another location for the maintenance of an equivalent number of required spaces in conformance with the provisions hereof, shall be in violation of this document.

P.12 Parking Lot Design and Landscaping Requirements

1. The landscaping and screening requirements set forth in the Little Rock Code of Ordinances, as it existed on the date of the most recent amendment to this Rule, shall be in full force and effect when erecting, constructing, enlarging or otherwise altering or improving a vehicular use area. The Commission may approve reductions, on a case-by-case basis, for any required landscaping area not adjacent to a public right of way.

2. Refer to the Capitol Area Design Standards for additional standards relating to parking lot design (Section 7-203) and landscaping (Section 7-204). These standards are also appropriate for any large parking areas (greater than 20 spaces) in the Mansion Area.

P.13 Residential Parking

Utilization of front yard areas for parking is prohibited.

1. The location of one or more vehicles in the front yard of any residential dwelling for three (3) or more days in a given month shall be considered “utilization of the front yard area for parking”, and shall constitute a violation of the Capitol Zoning District Rules unless a valid temporary use permit has been issued for this parking use.

2. For the purposes of this standard, “front yard” shall mean any portion of a front yard or corner lot side yard which is not improved in accordance with Standard P8.

P.14 Required Parking Spaces By Use

USE

REQUIRED PARKING SPACES

1. CIVIC 1

All uses in this group

1 per employee or 500 gross sq. ft. of floor area, whichever is greater.

2. CIVIC 2

Church, synagogue, or temple, including Sunday School or other religious education facilities

1 for each 3 seats of main auditorium

Community center (public)

1 per 200 gross sq. ft. of floor area

Library, private and public

1 per 400 gross sq. ft. of floor area

Museum or art gallery

1 per 200 gross sq. ft. floor area

Nursery school, daycare, or kindergarten

1 per employee

Parish house, parsonage, rectory or manse

2 per dwelling unit

School, elementary

1 per employee

School, secondary

1 per employee plus 1 per 500 gross sq. ft. of floor area

Studio: dance, drama, visual arts, music, etc

1 per 100 gross sq. ft. of floor area or 1 per 25 sq. ft. of classroom or studio space or 1 per 2 students enrolled, whichever is greater.

Swimming pool (public)

1 per 400 gross sq. ft. of pool and deck area

Theatrical group, community theatre

1 per 400 gross sq. ft. of floor area

Tennis courts (public)

1.5 per court

Meeting facility or tour home

1 per 300 gross sq. ft. of floor area

3. CIVIC 3

College, junior college, professional school or university (public or equivalent private)

1 per 3 seats for patron use

Eleemosynary institutions, philanthropic institution

1 per 400 gross sq. ft. of floor area

Club or lodge

1 per 200 gross sq. ft. of floor area

Rehabilitation institution

1 per 400 gross sq. ft. of floor area

Hospital (general) and those restricted to mental, narcotics or alcoholic patients or sanatorium

1 per 3 beds

Mental institution

1 per employee

USE

Trade or vocational school

Zoological gardens (public)

4. RESIDENTIAL

Single family dwelling

Two family dwelling and multi-family dwelling

Group living

Bed and breakfast house

5. OFFICES

For all uses in these use groups

6. LODGING AND AMUSEMENT

Commercial arena or auditorium*

Bowling alley*

Hotel or Motel*

Motion picture theatre*

Swimming pool; commercial (exempted from enclosure)

Tennis court; commercial (exempted from enclosure)

All other uses in this group

7. COMMERCIAL

Bed and Breakfast Inn

Restaurant

Storage for retail uses (maximum 20% of total building area)

For all other uses in these Use Groups

For structures larger than ten thousand (10,000) gross square feet, parking shall be provided as follows:

REQUIRED PARKING SPACES

1 per 100 gross sq. ft. of floor area, or 1 per 25 sq. ft. of studio space, or 1 per 2 students enrolled, whichever is greatest

1 per 400 gross sq. ft. of floor area

1 per dwelling unit

1 per 1 bedroom unit, 1.5 per 2 bedroom unit or more

1.5 per 2 bedrooms

1 per guest room, plus 1 for residence

1 per 350 gross sq. ft. of floor area.

1 per 3 seats

3 per alley

1 per guest room

1 per 3 seats

1 per 200 gross sq. ft. of pool

2 per court

1 per 200 gross sq. ft. of floor area

1 per guest room, plus 1 for resident(s)

1 per three (3) seats

1 per 400 sq. ft. floor area

1 space per 300 gross sq. ft. of floor area.

10,001 to 20,000 sq. ft. - 95% of Parking Requirement
20,001 to 30,000 sq. ft. - 90% of Parking Requirement
30,001 to 40,000 sq. ft. - 85% of Parking Requirement
40,001 to sq. ft. and up - 80% of Parking Requirement

USE

REQUIRED PARKING SPACES

8. INDUSTRIAL

For all uses in this group, except warehousing & storage

1 per 300 gross sq. ft. of floor area.

Warehouse and storage

1 per 400 gross sq. ft. of floor area

SECTION 3-401 SIGNAGE REQUIREMENTS

It is the purpose of this section to regulate signage within the Capitol Zoning District to prohibit unsafe, inadequately maintained, improperly sited, and aesthetically obtrusive signs which detract from the health, safety, welfare, convenience and enjoyment of the area's residents, property owners and visitors. These requirements are not intended to regulate any specific commercial, political, or otherwise protected content or speech, but only the general nature of signage within the District, including the amount, location, and dimensions of signs, the means by which signs are installed and illuminated, and the duration of time after which a sign must be removed. *The letter "S" precedes each of the standards in this section to indicate they are signage requirements.*

S.1 SIGN DEFINITION

1. A sign, for the purposes of these rules, is any written identification or description, with or without illustration or other device, which is exposed to the view of potential clients or customers and/or the general public, located outside of a building or any such identification or description affixed or attached to the interior of a window and visible from a public right-of-way.

a. A wall sign is a sign attached to or erected against the wall of a building with the face parallel to the plane of the building wall.

b. A ground mounted sign is a sign supported by a sign structure secured in the ground and which is wholly independent of any building, fence, vehicle or other support.

c. A sign structure is any device which supports, has supported, or is designed or intended to support a sign, including any decorative cover or detailing.

d. A temporary sign is a sign not permanently attached or affixed to the ground or to a structure.

2. A sign, for the purposes of these rules, does **not** include:

a. Illustrations or devices with a primarily artistic purpose, or with no writing, such as public art installations or wall murals;

b. National and state flags, flags identifying military service branches, or other similar flags or banners;

c. Flags depicting a school, college, or sports team, or religious or political affiliations, or banners marking a holiday or season, or other similar flags or banners;

d. Decorative devices or emblems displayed on a residential mailbox, porch, or lawn;

e. With the exception of obscene or explicit material (see standard S.8.10) any storefront or interior displays, with or without writing, not directly affixed or attached to an exterior window;

f. Signs affixed to or painted on movable vehicles;

g. Any road, wayfinding, or traffic safety or regulatory signs installed by the City of Little Rock, Pulaski County, the State of Arkansas, Rock Region Metro, or other government or quasi-governmental agency;

h. Writing to indicate a street address;

i. Writing permanently carved, engraved or otherwise affixed to a historic structure by its original owner or builder, such as the lettering set traditionally into the entablature of a historic commercial building.

3. The dimensions related to signs in the Capitol Zoning District will are defined as:

a. **Sign area;** the square foot area enclosed in the smallest rectangle encompassing the sign face. With respect to signs which are composed of individual symbols, letters, figures, illustrations, message, forms or panels, sign area shall be considered to include all lettering, wording, and accompanying designs and symbols, together with the background on which they are displayed, and frame around the sign and “cutouts” or extensions, but shall not include any supporting structure or bracing. The area shall be computed as including the maximum number of faces viewable from any single ground position as follows:

i. Double faced sign - one face counted.

ii. “V” sign with 45 degree or greater angle - two faces counted.

b. **Sign height:** the vertical distance measured from the surrounding grade to the highest point of the sign structure.

c. **Sign setback:** the minimum horizontal distance between the property line and edge of the sign or sign structure, whichever is closer. Any ground mounted sign in the Capitol Zoning District should be set back five feet from all property lines.

S.2 Allowable Signage in Zones A, C and D

Signs consistent with these requirements, per each permitted use, may be approved at the staff level:

1. One wall sign not to exceed 24 square feet. Wall signs shall be located on a vertical surface of the building including canopies, wing walls, etc., but not higher than the eave or rafter line of the wall on which located.

2. One ground-mounted sign not to exceed 24 square feet in area nor six (6) feet in height. Any property which has more than 300 feet of frontage on a public street or streets may display one (1) additional ground sign for each 300 feet of frontage in excess of the first 300 feet of frontage. However, no property may display a ground sign within 250 feet of any other ground sign installed on the same property.

3. One additional wall sign, in lieu of a ground-mounted sign, not to exceed 24 square feet.

4. Any illumination shall be indirect, and shall be directed downward, in conformance with the exterior lighting standards in Section 3-501.

S.3 Allowable Signage in Zones B, N and O

Signs consistent with these requirements, per each permitted use, may be approved at the staff level:

1. One wall mounted sign up to 18 square feet plus 2 square feet for each 10 feet that the building sets behind the property line, but not to exceed 28 square feet. Wall signs shall be located on a vertical surface of the building including canopies, wing walls, etc., but not higher than the eave or rafter line of the wall on which located.

2. One ground mounted sign not to exceed 18 square feet in area, nor six feet in height. Any property which has more than 300 feet of frontage on a public street or streets may display one additional ground sign for each 300 feet of frontage in excess of the first 300 feet of frontage. However, no property may display a ground sign within 250 feet of any other ground sign installed on the same property.

3. One additional wall sign on another wall of premises or in combination with sign on wall containing the major entrance, in lieu of a ground mounted sign, not to exceed 18 square feet.

4. Any illumination shall be indirect and shall be directed downward, in conformance with the exterior lighting standards in Section 3-501.

S.4 Allowable signage in Zone M

Signs consistent with these requirements may be approved at the staff level:

1. For properties used primarily for permitted non-residential uses, one wall mounted sign not to exceed six (6) square feet, **or** one ground mounted sign not to exceed six (6) square feet in area nor six feet in height.

2. For properties primarily used as residences, one wall mounted sign, denoting the name of the occupants or complex, not exceeding one (1) square foot. For properties with permitted home occupations, one additional sign, not to exceed one square foot, is also allowed.

3. Any property used primarily for a permitted civic use and which has more than 300 feet of frontage on a public street or streets may display one (1) additional ground sign for each 300 feet of frontage in excess of the first 300 feet of frontage. However, no property may display a ground sign within 250 feet of any other ground sign installed on the same property.

4. Any illumination shall be indirect and shall be directed downward, in conformance with the exterior lighting standards in Section 3-501.

S.5 Other signs allowed by right

The following signs are allowed in every zone unless noted otherwise noted. Signs consistent with these requirements may be approved at the staff level and will not be counted as part of the maximum signage allowed in Standards S2, S3, and S4 above:

1. **Signs located in or adjoining parking areas:** All Use Groups, except Residential 1, are allowed:

a. one sign per entry / exit to a parking area, not to exceed four square feet in area nor six feet in height, and not obstructing traffic or vision; and

b. one sign per parking space, not to exceed one-half square foot in area, nor three feet in height.

2. **Signs at delivery points:** All Use Groups, except Residential 1, are allowed one wall-mounted sign, not to exceed four square feet, to be installed at or near a delivery point.

3. **Signs for properties with more than one permitted non-residential use:** one wall-mounted sign, not to exceed 12 square feet, to be located near the main public entrance.

3. **Storefront signs for properties with permitted non-residential uses:** up to five additional signs, none exceeding two square feet, may be affixed non-permanently (such as with adhesive tape or suction cups, etc) to storefront windows, the storefront door, or adjacent to the main public entrance.

4. **Signs at historic properties:** Any property that is

a. Listed in the Arkansas Register of Historic Places;

b. Listed in the National Register of Historic Places;

c. Listed as a contributing resource in a historic district listed in the National Register; and/or

d. Has been approved to participate in a historic marker program sponsored by the Quapaw Quarter Association, Preserve Arkansas, Department of Arkansas Heritage, or other similar entity;

is allowed up to two signs, one of which may be ground mounted. A wall mounted sign may not exceed two (2) square feet. A ground mounted sign may not exceed four (4) square feet in area, nor six (6) feet in height.

S.6 Temporary signs

A temporary sign consistent with one of these descriptions shall not require a separate permit:

1. **Signs at properties undergoing permitted construction or rehabilitation:** One ground or wall mounted sign not to exceed 20 square feet in area nor six feet in height, may be displayed at the time construction begins and must be removed within 10 days following the conclusion of work.

2. Signs prior to an election: Any size or number of signs may be displayed up to 45 days prior to an election date. Such signs shall be removed within 10 days after the election.

3. Signs at properties listed for sale or lease: One sign per parcel or storefront, not to exceed 20 square feet in area nor six feet in height. Such signs must be removed within two weeks after conveyance or occupancy of the property or unit.

4. Signs prior to a holiday: Any sign may be displayed up to four weeks before and two weeks after a recognized civic or religious holiday.

5. Signs for permitted civic uses:

a. For a civic use sponsoring a special event, up to three signs may be displayed two weeks prior to the special event. Such signs shall be removed immediately following the event.

b. For civic uses that sponsor ongoing daily or weekly activities, any sign which is removed from the public view immediately following the activity.

6. Signs for approved temporary uses: Any property with an approved by a Temporary Use Permit may display a sign or signs described in the permit. Such signs shall be removed immediately upon expiration of the permit.

S.7 Signs allowed with Commission review

1. These signs will be considered by the Commission on a case by case basis:

a. Projecting signs: Wall-mounted signs which project more than six inches from the façade on which they are mounted, will be considered only within the Capitol Area and in Zone O, and may not exceed 18 square feet in area, nor project more than five feet from the building façade, nor interfere with pedestrian traffic. Such signs may be considered in addition to, or in lieu of one of, the signs allowed by right for the zone.

b. Historic signs: Signs originally fabricated for use in the District, or replicas of such signs, may remain or be reinstalled at their original locations in the District, based on physical, documentary, or photographic evidence. Historic signs relocated from elsewhere will also be considered, within the Capitol Area and in Zone O, to facilitate the preservation of such signs. Such signs may be considered in addition to, or in lieu of one of, the signs allowed by right for the zone.

c. Internally-lit signs: Signs with an internal light source, including neon signs, will be considered only within the Capitol Area and in Zone O.

d. Extra signage: Proposed signs exceeding the number or dimensions for allowed signage set forth in Standards S.2 through S.6, but not exceeding twice the number of allowed signs, nor 150% of the maximum allowed area or height for any individual sign.

2. When evaluating the appropriateness of a proposed sign, the Commission shall consider the following criteria:

a. Compatibility with surrounding properties and streetscape.

b. The total height, area, and location of the proposed sign(s), as well as any other existing signs on the property.

c. Materials, lighting, and method of installation or attachment.

d. Whether any significant historic or architectural features of the property will be obscured, damaged, or otherwise affected.

e. For temporary signs, the length of time the sign(s) will be displayed.

S.8 Prohibited signs

The following signs are prohibited within the Capitol Zoning District:

- 1. Signs on fences, utility poles, or natural elements**
- 2. Signs which create traffic hazards**
- 3. Signs not permanently attached** (except those temporary signs described in S.7)
- 4. Abandoned signs:** any sign displayed for a period of 60 days after the abandonment of a permitted use.
- 5. Roof signs:** any sign mounted or attached to the roof of a structure, or extending above the lowest portion of the roof line.
- 6. Marquee signs:** any sign with manually or electronically changeable copy, except for those associated with a permitted cinema, theatre, or similar performance venue
- 7. Animated, flashing or changing signs:** any sign that features action or motion, flashing or intermittent lighting, or automatically changing copy, including video signs.
- 8. Projecting signs** (prohibited in Mansion Area Zones M & N only)
- 9. Portable signs** (except those described in S.7)
- 10. Explicit or obscene material:** any sign, picture, publication, display of explicit graphics or language or other advertising which is distinguished or characterized by emphasis depicting or describing sexual conduct or sexual activity, displayed in windows, or upon any building or grounds, or visible from sidewalks, walkways, roads, highways, or any public area. (This provision shall not be interpreted to limit signage which constitutes political speech or artistic expression.)

S.8 ADMINISTRATION OF SIGN REGULATIONS No sign, other than those temporary signs not specifically required to have a permit (see S.6, above), shall be erected, relocated or otherwise altered in height or size without securing an appropriate permit from the Capitol Zoning District Commission.

S.9 NON-CONFORMING SIGNS All signs which became non-conforming as a result of the 1998 Capitol Zoning Master Plan, as amended, shall be removed by the owner or lessee or made to conform upon abandonment of the property's principal use (see Section 2-108) or expiration of the permit under which the property was operating. The Commission may, on a case by case basis, approve Certificates of Appropriateness for the installation of the following non-conforming signs:

- 1.** Historic signs reinstalled at their original locations in the District, or replicas of such signs.
- 2.** Historic signs relocated from elsewhere, to facilitate the preservation of such signs.

SECTION 3-501 OUTDOOR LIGHTING REQUIREMENTS

The purpose of this section shall be to regulate outdoor lighting on public and private property to help reduce energy waste, to minimize glare and over lighting that can result in hazardous conditions for all modes of transportation, and to reduce light pollution that detracts from the dignity and character of the Capitol Zoning District and from enjoyment of the night sky by individuals. Lighting levels should be designed to avoid light trespassing onto adjacent properties or the public right of way. *The letter "L" precedes each of the standards in this section to indicate they are lighting requirements.*

L1. Light poles may not exceed 35' in height.

L2. No outdoor lighting fixture may be installed, reinstalled, moved or maintained:

1. Unless it is shielded, hooded and aimed downward toward the ground surface.
2. In a manner that shines, reflects, or causes direct light or glare beyond the property where the fixture is installed.
3. That features “sag” or “drop” style lenses under canopies or overhangs.
4. That exceeds forty-thousand (40,000) lumens.

L3. This section shall **not** apply to:

1. Outdoor lighting fixtures of 1,700 lumens or less.
2. Outdoor lighting providing illumination and safety for workers repairing or maintaining streets, utilities, or other public infrastructure.
3. Outdoor lighting fixtures legally installed before the effective date of this section, unless the existing fixtures are repaired, moved or replaced, or are determined to create direct light or glare that extends beyond the property where the fixture is installed.
4. Outdoor lighting installed and operating in compliance with any applicable federal safety regulations, such as those necessary for aircraft navigation.
5. Recreational or sports field lighting fixtures, if such lighting is extinguished within one (1) hour after the last use of the facilities for the day.
6. Lighting for national, state, or other similar flags or public monuments.
7. Lights that are controlled by a motion-sensor switch and which do not remain on longer than 10 minutes after activation.
8. Lighting in observance of religious or civic holidays.

SECTION 3-601 TREE PROTECTION

Mature trees contribute to the unique character and dignity of the Capitol Zoning District. These trees constitute a distinctive feature of the District and are important to preserve whenever feasible. *The letter “T” precedes each of the standards in this section to indicate they are tree protection requirements.*

T1. Removal of an existing tree is not allowed unless:

1. The tree is less than four inches in diameter at a point four and half feet (4.5’) above grade (or 12 inches in diameter at ground level if a point at 4.5’ is not available to measure); or
2. The tree has been damaged by a recent natural event to such an extent that CZDC staff finds it is clearly and plainly an imminent threat to life, property, or public safety.
3. A registered forester (licensed by the Arkansas State Board of Registration for Foresters), a Certified Forester (certified by the Society of American Foresters), or a Certified Arborist (certified by the International Society of Arboriculture) has affirmed in writing that:
 - a. the tree is dead or so badly damaged or diseased so as be an imminent threat to life, property, or public safety; or
 - b. the tree is of an invasive or undesirable species; or

c. removal of the tree is otherwise consistent with sound arboricultural or urban forestry practices; or

4. The tree is being removed to accommodate approved new construction, and

a. Removal will not reduce the lot's tree canopy coverage below 20% in residential zones (B, M, and N), or less than 10% in commercial zones (A, C, and O); or

b. A plan to mitigate the removal with a new tree or trees has been approved by the Commission. The new tree or trees must be of the same species as the removed tree, or of a species recommended in the in the City of Little Rock Landscape Ordinance, as it existed on January 1, 2017.

T2. No pavement may be installed, no parking spaces may be designated, and no vehicles or heavy equipment may be stored within the drip line or critical root area (whichever is larger) of any tree not approved for removal.

T3. Tree pruning shall be done in accordance with accepted industry standards that maintain both the appearance and health of the tree.

1. Trimming that does not remove more any portion of the trunk and less than ten percent (10%) of the canopy shall be construed as ordinary maintenance, and shall not require a permit. For staff-level approvals, pruning shall not involve a portion of the trunk, nor more than twenty-five percent (25%) of the canopy. The Commission will consider requests for more extensive pruning on a case-by-case basis.

2. The practice of "tree topping" – removing the entire top of a tree, or all its trunks and large branches above a certain height – is specifically prohibited.

SECTION 3-701 ARCHEOLOGY

The areas surrounding the State Capitol and Governor's Mansion have been home to human activity for centuries. Though uncommon, it is not unheard of for property owners to come across archeological evidence while undertaking a project or improvement. Archeological artifacts and, especially, remains must be treated with extreme sensitivity. *This Standard is marked with an "A" to indicate it relates to archeology.*

A1. Archeological evidence shall be identified and documented by an archeology professional. If any archeological evidence is found, any work that could potentially affect the evidence shall stop, and the commission staff shall be notified immediately, along with the Arkansas Archeological Survey and the Arkansas Historic Preservation Program.

SECTION 3-801 RENEWABLE ENERGY AND SUSTAINABILITY

As interest in renewable energy sources continues to grow in Arkansas, property owners in the Capitol Zoning District are encouraged to explore sustainable energy solutions in a manner compatible with the character of the District. *This Standard is marked with an "E" to indicate it relates to energy.*

E1. Systems or equipment for collecting or using alternative energy, such as that derived from solar, wind, or geothermal sources, should be compatible with the character of the District.

1. For staff approval, alternative energy equipment shall observe the same zoning requirements for height and setback as structures, and:

a. Systems attached to buildings shall be located on a roof plane not facing a street. For equipment attached to a historic building, see the Rehabilitation Standards for roofs (Section 4-207).

b. Freestanding systems shall be located in a rear yard and screened from any street views with fencing or vegetation.

2. The Commission will consider all other requests for alternative energy systems on a case-by-case basis.

ARTICLE FOUR
REHABILITATION STANDARDS FOR HISTORIC PROPERTIES

SECTION 4-101 PURPOSE & APPLICABILITY

A. Change is a sign of economic health and confidence in Little Rock's future. It is an essential process in a vital community, representing the current phase of an evolution that has been continuing since the beginning of the city. How we construct, where we build, and how we treat what is already established will determine the quality of life we provide for current and future generations. However, the character of change must be managed to assure that the heritage of Arkansas as represented in these special areas surrounding the State Capitol and Governor's Mansion is protected and that the urban framework will support and enhance the quality of life for residents and visitors.

Historic buildings should be treated with respect, and additions and other new buildings should strengthen the design context. If the imprint of new construction is to be positive, thoughtful consideration must be given to each change in the built fabric of the community. Uncontrolled demolition, alteration and insensitive new construction can irreparably alter the character of the area. Once lost, the ambience of the Mansion and Capitol Areas cannot be recaptured with any sense of authenticity. These Rehabilitation Standards for Historic Properties therefore are intended to guide the character of change such that the citizens of Arkansas will derive the maximum benefit of the State Capitol and Governor's Mansion Areas.

B. This article applies to the treatment of all historic properties within the jurisdiction of the Capitol Zoning District. The standards address treatment of existing historic features, repair of deteriorated details and replacement of missing elements.

C. An asterisk (*) adjacent to a statement in the text in this article indicates that it is a standard that will not be waived by the Capitol Zoning District Commission for historic structures or site features built during the District's period of significance and/or listed in the National Register of Historic Places, except as an Economic Hardship (see Section 2-105 C.4).

- 1.** For other historic structures or site features, these standards may be waived if it is demonstrated to the Commission's satisfaction that such a waiver will not adversely affect the historic character of the surrounding neighborhood.
- 2.** Compliance with other standards, without an asterisk, is also required, but may be waived if it is demonstrated to the Commission's satisfaction that such a waiver will not adversely affect the historic character of the surrounding neighborhood.
- 3.** Other text in this article, including principles, policies, and narrative sections, as well as illustrations, will also be considered by the Commission and staff when reviewing an application.

D. The letter "R" precedes each of the standards in this article, to indicate that it is a Rehabilitation Standard.

SECTION 4-102 PRESERVATION IN THE CAPITOL ZONING DISTRICT

Across the nation, thousands of communities promote historic preservation because doing so contributes to neighborhood livability and quality of life, minimizes negative impacts on the environment, preserves and passes on important elements of the community's past, and yields economic rewards. Many property owners also are drawn to historic resources because the quality of construction is typically high, and the buildings are readily adaptable to contemporary needs. All of these benefits apply in the Capitol and Mansion Areas.

Goals for the areas

The overall preservation goal is to maintain the integrity of the Capitol and Mansion Areas' individual historic structures and their settings. To maintain the character of a historic building, design elements such as form, mass and materials should be considered in any alteration of a property. Another goal for the areas is to preserve key character-defining features and details. The relationship a building has with other neighborhood design elements also is important. In particular, considering the hierarchy of site elements, such as street trees, secondary structures, historic street elements, front yards and walkways, is a high priority.

Construction quality

Many of the historic structures in the Capitol and Mansion Areas are of high-quality construction. Lumber used came from mature trees and was properly seasoned and typically was milled to “full dimensions,” which often yielded stronger framing. These structures also were thoughtfully detailed. The finishes of materials, including fixtures, wood floors and trim, were generally of high quality as well. By comparison, in today’s new construction, materials of such quality are rarely available and comparable detailing is very expensive. The high quality of construction in historic buildings is therefore a “value” for many people.

Adaptability

Owners also recognize that the floor plans of historic buildings easily accommodate comfortable life-styles and support a diversity of populations. Rooms are frequently large, permitting a variety of uses while retaining the overall historic character of each structure. Open space often exists on a lot to accommodate an addition, if needed.

Livability and quality of life

When groups of older buildings occur, they create a street scene that is “pedestrian friendly,” which encourages walking and neighborly interaction. Mature trees and architectural features also contribute to a sense of identity that is unique for the neighborhood, an attribute that is rare and difficult to achieve in newer areas. This physical sense of neighborhood can also reinforce desirable community social patterns and contribute to a sense of security.

Environmental benefits

Preserving a historic structure also is sound environmental conservation policy because “recycling” saves energy and reduces the need for producing new construction materials. Three types of energy savings occur. First, no energy is consumed to demolish the existing building and dispose of the resulting debris. Second, energy is not used to create new building materials, transport them and assemble them on site. Finally, the “embodied” energy, that which was used to create the original building and its components, is preserved. By “reusing” older materials as a historic building, pressure also is reduced to harvest new lumber and other materials that also may have negative effects on the environment of other locales where these materials are produced. Because older buildings often are more energy-efficient than new construction, when properly used, heating and cooling needs are reduced as well.

Living in historic neighborhoods also helps reduce Little Rock’s dependence upon automobiles. Because these older places are in close proximity to the original downtown, they provide opportunities for many people to work close to where they live, and because commuting distances are reduced, so are vehicle miles traveled. A reduction in gasoline consumed and in air pollution from emissions discharged are therefore positive results of living in historic neighborhoods.

Economic benefits

Historic resources are finite and cannot be replaced, making them precious commodities that many buyers seek. Therefore, preservation adds value to private property. Many studies across the nation document that, where historic districts are established, property values typically rise or at least are stabilized. In this sense, designation of a historic district appears to help establish a climate for investment. Although the Mansion Area, for example, is not a locally designated district, but rather a state administered zoning district, it functions much in the same way. Property owners within the Mansion Area know that the time and money they spend on improving their properties will be matched with similar efforts on surrounding lots; their investments will not be undermined by inappropriate construction next door.

The condition of neighboring properties also affects the value of one’s own property. People invest in a neighborhood as much as the individual structure itself and, in historic districts where investment is attracted, property owners recognize that each benefits from the commitment of their neighbors. An indication of the success of historic preservation is that the number of designated districts across the country has increased, due to local support, such that an estimated 1,000,000 properties, both as individual landmarks and in historic districts, are under local jurisdictions.

Preservation projects also contribute more to the local economy than do new building programs because each dollar spent on a preservation project has a higher percentage devoted to labor and to purchase of materials available locally. By contrast, new construction typically has a higher percentage of each dollar spent devoted to materials that are produced outside of the local economy and to special construction skills that may be imported as well. Therefore, when money is spent on rehabilitating a building, it has a higher “multiplier effect,” keeping more money circulating in the local economy.

Rehabilitating a historic building also can cost less than constructing a new one. In fact, the Standards for Rehabilitation of Historic Properties promote cost-saving measures. They encourage smaller and simpler solutions, which in themselves provide savings. Preserving building elements that are in good repair is preferred, for example, rather than replacing them. This typically is less expensive. In some instances, appropriate restoration procedures may cost more than less sensitive treatments. In such cases, property owners are compensated for this extra effort, to some extent, in the added value that historic designation provides.

Incentives for preservation

While the economic benefits of rehabilitation are substantial, some special incentives also exist to help offset potential added costs of appropriate rehabilitation procedures. Income tax credits and deductions are offered at the state and federal levels for certain appropriate rehabilitations.

Responsibility of ownership

Ownership of a historic property carries both the benefits described above and also a responsibility to respect the historic character of the property and its setting. While this responsibility does exist, it does not automatically translate into higher construction or maintenance costs. Ultimately, residents and property owners should recognize that historic preservation is a long-range community policy that promotes economic well-being and overall viability of Little Rock at large and that they play a vital role in helping to implement that policy through careful stewardship of the area’s historic resources.

SECTION 4-103 BASIC PRESERVATION THEORY

The Concept of Historic Significance

What makes a property historically significant? In general, properties must be at least 40 years old before they can be evaluated for potential historic significance, although exceptions do exist when a more recent property clearly has historical value. Historic properties must have qualities that give them significance. A property may be significant for one or more of the following reasons:

- Association with events that contributed to the broad patterns of history, the lives of significant people or the understanding of the community’s prehistory or history.
- Construction and design associated with distinctive characteristics of a building type, period or construction method.
- An example of an architect or master craftsman or an expression of particularly high artistic values.
- Integrity of location, design, setting, materials, workmanship, feeling and association that form a district.
- An established and familiar natural setting or visual feature of the community.

Period of Significance

In most cases, a property is significant because it represents or is associated with a particular period in its history. Frequently, this begins with the construction of the building and continues through the peak of its early occupation. Building fabric and features that date from the period of significance typically contribute to the character of the structure. Historic neighborhoods also have a period of significance. The Mansion Area, for example, has a period of significance which spans approximately 60 years (1880-1940). Throughout this period of significance, the district has been witness to a countless number of buildings and additions which have become an integral part of the neighborhood. Conversely, several structures have been built or alterations have been made after this period which are generally considered no historic and may be considered for removal or replacement. In general keep this in mind:

- Early alterations, additions or new construction (more than 40 years old) may have become historically significant and thus merit preservation.
- Many additions or alterations to buildings and districts that have taken place in the course of time are themselves evidence of the history of the building and its neighborhood and therefore may merit preservation.

More recent alterations, additions or new construction that are not historically significant may be removed.

- For example, asphalt, aluminum, vinyl or other synthetic siding may presently obscure the original clapboard siding. In this case, removal of this alteration and restoration of the original material is strongly encouraged.
- Most alterations less than fifty years old lack historic significance.

Concept of Integrity

In addition to being from a historical period, a property also must have integrity, in that a sufficient percentage of the structure must date from the period of significance. The majority of the building's structural system and materials should date from the period of significance and its character defining features also should remain intact. These may include architectural details, such as dormers and porches, ornamental brackets and moldings and materials, as well as the overall mass and form of the building. It is these elements that allow a building to be recognized as a product of its own time.

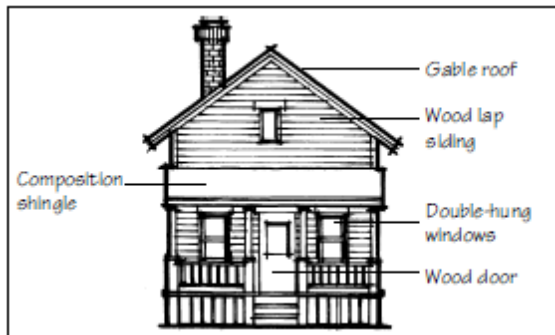

This property retains a high degree of integrity: most of the original features and materials survive.

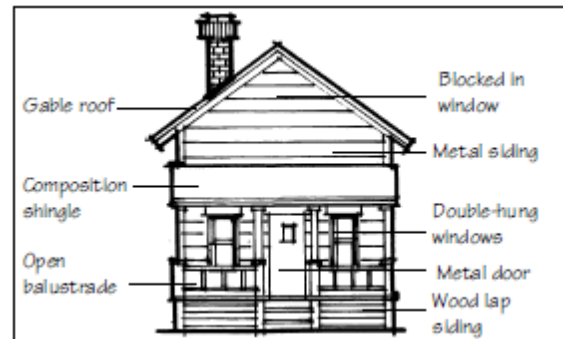

In this case, the building has lost some of its original features and materials and integrity has been compromised. Nonetheless, these losses are retrievable and therefore the building would retain its historic integrity.

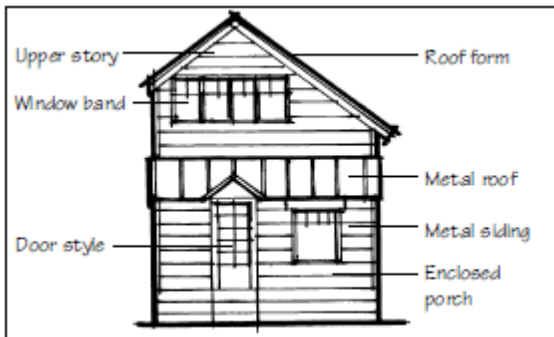

A building in this condition has lost a substantial amount of details and materials. It is no longer possible to adequately interpret its historic character and therefore, has lost its historic integrity.

SECTION 4-104 PRESERVATION PRINCIPLES

The following preservation principles should be applied to all historic properties in the Capitol Zoning District:

Principle 1: Respect the historic design character of the building.

Don't try to change its style or make it look older than it really is. Confusing the character by mixing elements of different styles also is an example of disrespect.

Principle 2: Seek uses that are compatible with the historic character of the building.

Building uses that are closely related to the original use are preferred. Every reasonable effort should be made to provide a compatible use for the building that will require minimal alteration to the building and its site.

Principle 3: Protect and maintain significant features and stylistic elements.

Distinctive stylistic features or examples of skilled craftsmanship should be treated with sensitivity. The best preservation procedure is to maintain historic features from the outset so that intervention is not required. Protection includes the maintenance of historic material through treatments such as rust removal, caulking, limited paint removal and reapplication of paint.

Principle 4: Preserve any existing original site features or original building materials and features.

Preserve original site features such as hitching posts, rock walls, etc. Avoid removing or altering original materials and features. Preserve original doors, windows, porches and other architectural features.

Principle 5: Repair deteriorated historic features, and replace only those elements that cannot be repaired.

Upgrade existing material, using recognized preservation methods whenever possible. If disassembly is necessary for repair or restoration, use methods that minimize damage to original materials.

SECTION 4-201 HISTORIC STREETScape & SITE DESIGN FEATURES

Policy: Historic streetscape and site features that survive should be preserved. In addition, new features should be compatible with the historic context.

Background

A variety of streetscape features, including street trees, sidewalks and curbs, appeared early in the Mansion and Capitol Areas. Walkways and planting strips were popular and defined the front property line. A variety of plantings in the planting strip and front lawns also was seen. Each of these elements contributed to the historic character of these neighborhoods. Most of these features survive in the Mansion Area, and their preservation is an important objective.

Sidewalks

Concrete sidewalks are also historically significant elements that contribute to the neighborhood's inviting atmosphere and provide spaces for walking and personal interaction. A few stone pavers also survive in public sidewalks. These accent the scene and should be preserved.

Walkways

Walkways are usually straight and lead from the sidewalk to each house entry. The rhythm of these walkways spaced along the street contributes to a sense of visual continuity in the Mansion Area and to a few blocks in the Capitol Area. This progression of spaces, combined with landscape features such as fences and walls, greatly enhances the street scene. Most walks are also of concrete, although some brick and stone walks survive. Each of these contributes to the historic character of the area and should be preserved.

Fences

Historically, most properties were not fenced, but several examples of the use of fences survive today indicating that, while not universal features, they were important accents. When used, fences were simple wood picket and cast or wrought iron, usually in front and side yards. These were relatively low in height and had a "transparent" character that allowed views into yards, providing interest to pedestrians. A noteworthy example is at the Villa Marre on Scott.

Retaining Walls

Occasionally masonry retaining walls occur in the Mansion and Capitol Areas. Many of these are short stone curbs at the inside sidewalk edge. In some cases, however, these walls rise to as much as four feet, such as along the 1500 block of Spring Street. These may have distinct mortar characteristics. The color and finish of the brick or stone, as well as its mortar style, are distinctive features that should be preserved.

Trees and other plant materials

Traditionally, foundation plantings were installed around many residential structures and other decorative plants were located in beds along property lines. Individual specimen trees were located throughout the areas. Mature trees are distinctive features of the Mansion Area that are especially important to preserve where feasible. Street trees, located in the planting strip between the curb and the sidewalk, are also important features that should be maintained.



A tree-lined planting strip, front lawns and low scale fences are elements of traditional site designs in the Mansion Area.

STREETSCAPE AND SITE DESIGN STANDARDS

Planting Strip

R1.1 Maintain the character of the public planting strip.

- Preserve the character of the streetscape and any historically significant planting designs.
- Existing street trees that are in good condition should be maintained. If removal of a street tree is necessary in the public right of way, replanting with a species that is similar in character to that used historically should be considered.
- Planted turf is preferred. Avoid replacing plant materials with hard surfaces.

Sidewalks

R1.2 Preserve historic sidewalks.

- The alignment with other original sidewalks, the street and overall grid is of primary importance.
- Replace only those portions that are deteriorated beyond repair. Any replacement materials should match the original in color, texture, size and finish.

R1.3 When new sidewalks are to be installed, they should be compatible with the historic character of the streetscape.

- Sidewalks should be detached and separated from the curb with a planting strip.
- The concrete used for new sidewalks should be finished to match that of the original sidewalks.
- Modern finishes, such as exposed aggregate, are prohibited. Asphalt and brick are also inappropriate.

Do not cover grassy areas with gravel, rock or paving materials.



Maintain the character of the public planting strip. Sidewalks should be detached and separated from the curb with a planting strip.

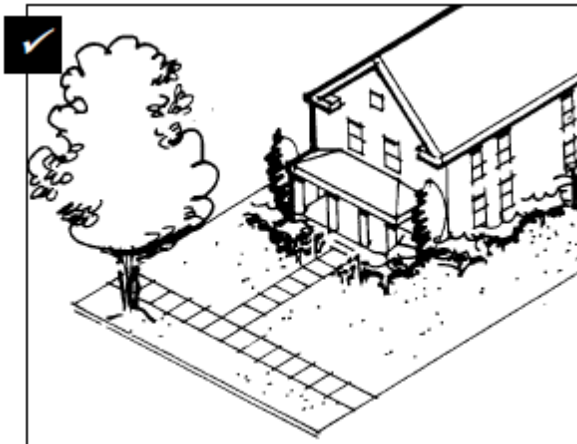

Maintain the established progression of public-to-private spaces in front yards. This includes a sequence of experiences, beginning with the "public" sidewalk, proceeding along a "semipublic" walkway, to a "semiprivate" porch or entry feature, and ending in the "private" spaces beyond.

Walkways

R1.4 Maintain the established progression of public-to-private spaces in front yards.

- This includes a sequence of experiences, beginning with the "public" sidewalk, proceeding along a "semipublic" walkway, to a "semiprivate" porch or entry feature, and ending in the "private" spaces beyond.
- Provide a walkway running perpendicular from the street to the front entry.

R1.5 Use paving designs that are similar to those employed historically for front yard walkways.

- Stone, concrete or brick are appropriate materials for private, front yard walks.
- The paving design should be compatible with the building style.

R1.6 Preserve historic walkways in front yards.

- Preserving historic stone and brick paving is particularly important.
- The historic paving pattern and mortar details also should be preserved.



Experiencing the progression from the public sidewalk, into the yard and onto a porch is one of the most important character defining features of residential construction. This feature should be preserved with historic buildings and also should be interpreted in new construction.



Fences

R1.7 Preserve original fences.

- Maintain a painted finish on wood fences. Many metal fences also should be painted.
- Replace only those portions that are deteriorated beyond repair.
- Preserve significant design details, such as finials and newel posts.

R1.8 A new front yard fence should be in character with those seen historically.

- The fence should be in keeping with the building style.
- A metal picket fence, in the character of traditional wrought iron, is preferred. A painted wood picket fence also is an appropriate alternative in most locations. Pickets should be evenly spaced. Post-and-rail designs are discouraged.
- A fence that defines a front yard is usually low to the ground (40 inches or less). This scale should be maintained.
- Unpainted wood, chain link and solid "stockade" fences are inappropriate materials in front yards.
- Newel posts should be in character with the fence. Decorative metal newel posts should be used with wrought iron, for example.
- Requests for the use of masonry (brick, stone, or concrete) in front yard fences, either as pier supports or as a foundation material, will be considered by the Commission on a case-by-case basis.
- On corner lots, both sides that abut public sidewalks and/or streets should be treated as front yard fences.
- For the purposes of this section, a front yard is that portion of a parcel from the street to a line coplanar with the building's front façade, not including the front porch. For corner lots, the front yard will continue along the side façade facing the cross street to a line coplanar with either the rearmost corner of the building, not including any rear porches or non-historic rear additions, or with the required rear yard setback.
- Chain link fences are generally inappropriate for historic properties in the District and should be limited to locations not substantially visible from a public right-of-way.



A fence that is low to the ground and "transparent" in nature, such as this wrought iron fence, is appropriate.

R1.9 The height of any fence will be measured from the grade on the side of the fence facing the public right-of-way.

- For fences set on top of a masonry base, such as a retaining wall or concrete footer, the base will be included when measuring the fence's total height.
- Taller fences may be considered on a case-by-case basis when they are set farther back from the property line or other required setback.

R1.10 A solid fence may be used in a rear or side yard.

- Although the use of transparent fences is also encouraged in rear and side yards, a solid stockade fence may be used where privacy is a concern. The Commission will consider requests for masonry (brick or stone) privacy fences on a case-by-case basis.
- Privacy fences used in back yards and along alleys should be 72 inches (6 feet) or less.
- For the purposes of this section, the rear and side yards are those portions of a parcel not covered by the main structure or defined as a front yard, above.
- A backyard fence on corner lot with an adjoining property to the rear should be set back from the right-of-way according to either the front yard setback for that zone, or coplanar with the front façade of the building behind it (if any) on an adjoining property, whichever is less.

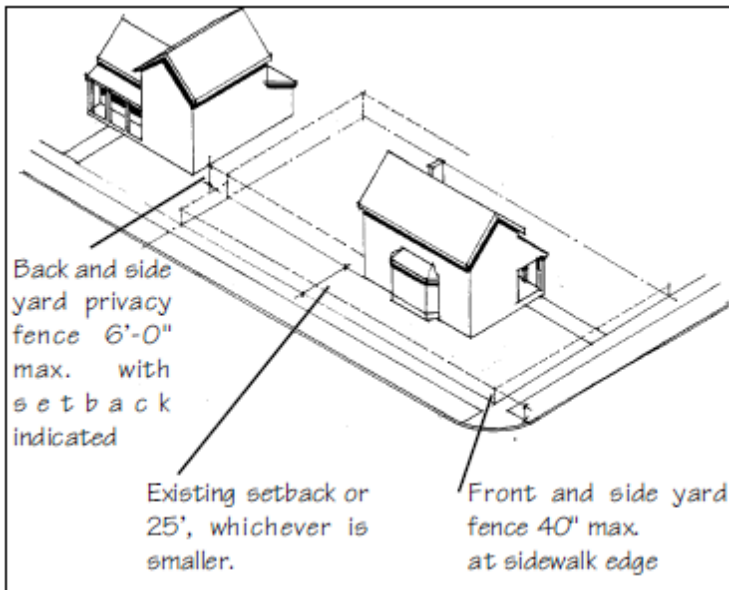

Fence height and setback requirements for a corner lot with an adjacent structure to the rear.



A new fence should be in character with those seen historically.



Although the use of transparent fences is also encouraged in rear yards, a solid stockade fence may be considered where privacy is a concern. Also preserve an original retaining wall.

Retaining Walls

R1.11 Preserve original retaining walls.

- If repointing is necessary, use a mortar mix that is similar to that used historically and apply it in a joint design that matches the original.
- Replace only those portions that are deteriorated beyond repair. Any replacement materials should match the original in color, texture, size and finish.
- Painting a historic masonry retaining wall, or covering it with stucco or other cementitious coatings, is inappropriate.

R1.12 Maintain the original height of a retaining wall.

- Increasing the height of a wall to create a privacy screen is inappropriate. If a fence is needed for security, consider using a wood or iron one similar to those seen historically that is mounted on top of the wall.

R1.13 For a replacement retaining wall, use materials that appear similar to that of the original.

- The color and finish of the brick or stone, as well as its mortar style, are distinctive features that should appear in replacement walls.

R1.14 New retaining walls should be similar in height, depth, apparent construction and function to historic retaining walls in the area.

- Materials for new retaining walls should be those used historically in the area for this purpose; i.e. stone and brick.
- In some cases, alternate materials, such as textured concrete block, may be appropriate when the material substantially resembles the materials used for this purpose historically.
- Installation of a retaining wall to facilitate a substantial change in the historic topography of a site is generally inappropriate.

Yard Designs

R1.15 Preserve the traditional character of residential front yards.

- The front yard should be predominantly lawn, with planting material.
- The use of paved surfaces should be minimized.

R1.16 Avoid using plant materials that may damage historic building materials.

- Avoid planting climbing ivy on building walls
- Also avoid locating plant materials or trees too close to a building.

R1.17 Preserve mature trees when feasible.

- Removal of mature trees is strongly discouraged.
- See General Standards for Tree Protection.

Parking Areas and Driveways

R1.18 Locate parking to the side or rear.

- Place parking in the rear when feasible. Locating to the side may also be appropriate.
- Locating parking in front of a building is inappropriate.

R1.19 Screen parking areas from the public way.

- Planting beds and hedges are preferred.
- Low masonry walls or fences that are in character with those seen historically may be considered.

R1.20 Include landscaped areas in large parking lots.

- See the detailed landscape standards for parking lots in the parking sections in the Design Standards for the Mansion and Capitol Areas.

R1.21 Minimize the visual impacts of driveways as seen from the street.

- Providing access from an alley is preferred, rather than creating a new curb cut.
- Use porous paving materials, such as grasscrete or consider using paving strips in order to reduce the amount of hard surface in the front yard.



Distinctive landscape features include retaining walls, lawns and foundation plantings.



Preserve the traditional character of residential front yards.

SECTION 4-202 HISTORIC BUILDING MATERIALS

This section addresses the treatment of primary historic building materials, those that compose the dominant exterior surfaces of historic buildings. The treatment of materials used for architectural trim is addressed in a separate section.

Policy: Primary historic building materials should be preserved in place whenever feasible. When the material is damaged, limited replacement which matches the original should be considered. Primary historic building materials should never be covered or subjected to harsh cleaning treatments.

Typical Materials

In the Capitol and Mansion Areas, painted wood siding and brick were typical primary building materials used historically. A variety of lap profiles were used, but a clapboard siding, with a four-inch exposure, was the most typical. Board and batten siding was occasionally applied to accessory structures. Brick appeared on some of the grander houses as well as commercial and institutional structures. Brick buildings include the New Hotze House, the Turner- Ledbetter House and Trinity Cathedral. Masonry also was used frequently for foundations of wood sided structures. A few examples of the early use of stucco also exist.

In each case, the distinct characteristics of the primary building material, including the scale of the material unit, its texture and finish, contribute to the historic character of a building. For example, because the standard lap dimensions of wood siding are so distinctive from the historic period, they play an important role in establishing the scale of historic buildings. In a similar manner, the size, color and finish of original brick are important characteristics of historic masonry structures.

Maintaining Materials

Maintaining exterior building materials in good condition is essential to the preservation of historic structures. The best way to preserve historic building materials is through well planned maintenance. Wood surfaces should be protected with a good application of paint, for example, and mortar joints should be maintained in masonry walls.

Maintaining trim pieces associated with wood siding is also essential because they help to seal joints where moisture can penetrate the building wall. Corner boards protect the ends of lap siding, for example, while fascia boards help keep water from entering under eaves.

Maintaining Masonry Walls

With regard to masonry walls, maintaining mortar joints is an important consideration. Masonry walls may have eroded because water has "wicked" up through the wall, or cracks may have opened as a result of uneven settlement of the foundation. In any case, these openings in the masonry construction may expose the wall to further deterioration.

When repointing is required, it is important that a mortar mix be used that is similar in character to that used historically, both in terms of its appearance and also in its composition. Historically, mortars contained high percentages of lime, which resulted in a flexible joint. More recent mortars employ high ratios of Portland cement, which is too hard for the softer brick used in many early structures. Repointing with Portland cement can actually accelerate deterioration of a historic masonry wall. It is best to use a high lime recipe, with a small amount of Portland cement for hardening while not making it so brittle as to damage the brick.

Repairing Materials

When deterioration occurs, repairing the material rather than replacing it is preferred. In other situations, however, some portion of the material may be beyond repair. In such a case, consider replacement. The new material should match the original in appearance. If wood siding had been used historically, for example, the replacement also should be wood.

It is important, however, that the extent of replacement materials be minimized because the original materials contribute to the authenticity of the property as a historic resource. Even when the replacement material exactly matches that of the original, the integrity of a historic building is to some extent compromised when extensive amounts of original materials are removed.

It is also important to recognize that all materials weather over time and that a scarred finish does not represent an inferior material but simply reflects the age of the building. Preserving original materials that show signs of wear is therefore preferred to their replacement.

Artificial Siding

Rather than replace siding, some property owners consider covering the original building material. Aluminum and vinyl are examples of materials that are often discussed. Using any material, either synthetic or conventional, to cover historic materials is inappropriate. Doing so would obscure the original character and change the dimensions of walls, which is particularly noticeable around door and window openings.

The extra layer may in fact cause additional decay, both by its method of attachment and because it may trap moisture inside the historic wall. For similar reasons, if original wall materials are presently covered with a more recent siding, remove the outer layer and restore the original. When damaged, synthetic materials also can be more difficult to repaint, repair or replace.

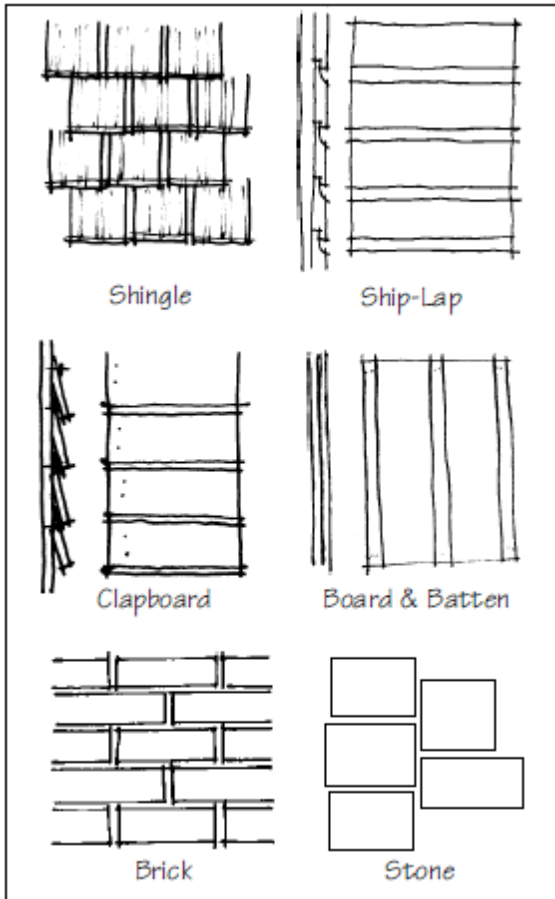

Protect wood features from deterioration. Maintain protective coatings to retard drying and ultraviolet damage. If the building was painted originally, it should remain painted.

Typical historic wall materials are wood, stone and brick.

STANDARDS FOR HISTORIC BUILDING MATERIALS

Treatment of Materials

*** R2.1 Preserve original building materials.**

- Avoid removing siding that is in good condition or that can be repaired in place.
- Remove only siding which is deteriorated and must be replaced.
- Masonry features that define the overall historic character, such as walls, cornices, pediments, steps and foundations, should be preserved.
- Avoid rebuilding a major portion of exterior masonry walls that instead could be repaired. Reconstruction may result in a building which is no longer historic.

R2.2 Protect wood features from deterioration.

- Provide proper drainage and ventilation to minimize rot.
- Maintain protective coatings of paint to retard decay and ultraviolet damage.
- Caulk joints to prevent water intrusion.

R2.3 Plan repainting carefully.

- Always prepare a good substrate. Remove damaged or deteriorated paint only to the next intact layer, using the gentlest means possible, prior to painting.
- Use compatible paints. Some latex paints will not bond well to earlier oil-based paints without a primer coat.

* **R2.4 Generally, brick or stone that was not painted historically should remain unpainted.**

- Masonry naturally has a water-protective layer, or patina, to protect it from the elements. Painting masonry walls can seal in moisture already in the masonry, thereby not allowing it to breathe and causing extensive damage over the years.
- Some of the earlier masonry buildings may be constructed of a very soft brick that lacks a water protective outer glaze. In these instances, painting the brick may be appropriate to provide protection. If permitted, the paint color must match that of the original brick.

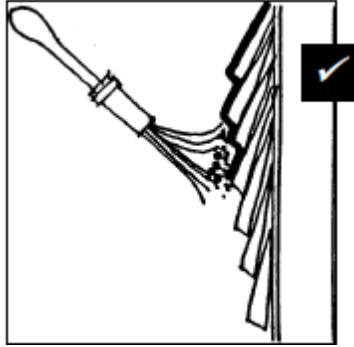

Plan repainting carefully. Always prepare a good substrate. Also, use compatible paints.



Some of the earlier masonry buildings may be constructed of a very soft brick that lacks a water-protective outer glaze. In these instances, painting the brick may be appropriate to provide protection.

Repair of Materials

* **R2.5 Repair deteriorated primary building materials by patching, piecing-in, consolidating or otherwise reinforcing the material.**

- Avoid the removal of damaged materials that can be repaired.
- Isolated areas of damage may be stabilized or fixed using consolidates. Epoxies and resins may be considered for wood repair, and special masonry repair components also may be used.

R2.6 Repoint mortar joints in masonry walls where erosion has occurred.

- Match the old mortar in strength, composition, color and texture.
- Avoid using mortar with a high Portland cement content, which will be substantially harder than the original.
- Match the original joints in width and profile.

R2.7 Use the gentlest means possible to clean the surface of a structure.

- Perform a test patch to determine that the cleaning method will cause no damage to the material surface. Many procedures can actually have an unanticipated negative effect upon building materials and result in accelerated deterioration or a loss of character.
- Harsh cleaning methods, such as sandblasting, can damage the historic materials, changing their appearance. Such procedures are inappropriate.
- If cleaning is appropriate, a low pressure water wash is preferred.

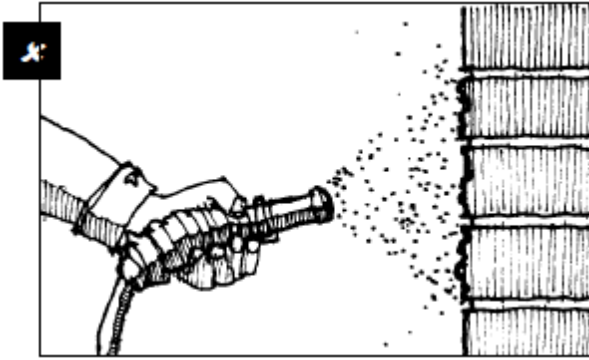

Use the gentlest means possible to clean the surface of a structure. Harsh cleaning methods, such as sandblasting, can damage the historic materials, changing their appearance. Such procedures are inappropriate.



Match the original material in composition, scale and finish when replacing materials on primary surfaces.

Replacement Materials

- * **R2.8 Match the original material in composition, scale and finish when replacing materials on primary surfaces.**
 - If the original material was wood clapboard, for example, then the replacement material should be wood as well. It should match the original in size, the amount of exposed lap and in finish.
 - If brick must be replaced, match the original in size, color and finish. Mortar joints for patched areas also should match those of the historic wall.
 - Replace only the material that is required. If a few boards are damaged beyond repair, then only they should be replaced, not the entire wall.
- * **R2.9 Using synthetic materials, such as aluminum or vinyl siding or panelized brick, as replacements for *primary* building materials is inappropriate.**
 - Modular materials should not be used as replacement materials. Synthetic stucco and panelized brick, for example, are inappropriate.
 - Using concrete block as a substitute for brick at a foundation also is inappropriate.

Covering Materials

- * **R2.10 Covering original building materials with new materials is inappropriate.**
 - Vinyl siding, aluminum siding and new stucco are inappropriate on historic buildings. Other imitation materials that are designed to look like wood or masonry siding, but that are fabricated from other materials, are also inappropriate.
- R2.11 Consider removing later covering materials that have not achieved historic significance.**
 - If a property already has a non-historic building material covering the original, it is not appropriate to add another layer of new material, which would further obscure the original.
 - Once the non-historic siding is removed, repair the original, underlying material.



Imitation materials that are designed to look like wood or masonry siding, but that are fabricated from other materials, are inappropriate.



Wood is a typical Little Rock siding and is an appropriate material.

SECTION 4-203 WINDOWS

Policy: The character-defining features of historic windows and their distinctive arrangement on a wall should be preserved. In addition, a new window should be in character with the historic building. This is especially important on primary facades.

Background

Windows are some of the most important character-defining features of historic structures. They give scale to buildings and provide visual interest to the composition of individual facades. Because window designs so significantly affect the character of a historic structure, the treatment of a historic window and the design of a new one are therefore very important considerations.

Window Features

The size, shape and proportions of a historic window are among its essential features. Many early residential windows in the Mansion Area were vertically-proportioned, for example. Another important feature is the number of “lights,” or panes, into which a window is divided. Typical windows for many late nineteenth century houses were of a “one-over-one” type, in which one large pane of glass was hung above another single pane.

The design of surrounding window casings, the depth and profile of window sash elements and the materials of which they were constructed are also important features. Most early windows were made of wood although some historic metal casement windows are found. In either case, the elements themselves had distinct dimensions, profiles and finishes. (See the discussion of individual building styles in Appendix C for additional information about specific window types.) All of these features are elements of historic window designs that should be preserved.

Shutters and Awnings

Wooden shutters were used occasionally in turn-of-the century Little Rock houses. Typically, they were constructed of a wood frame and had wood slats. They were mounted on metal hinges and were opened and closed in response to varying weather and light conditions.

Fabric awnings appeared on many historic commercial buildings along the northern portions of Main Street. They were rarely used on residences, although some awnings may have been applied in the mid-twentieth century. Those that were most compatible were made of fabric and were mounted on operable frames.



Because window designs so significantly affect the character of a historic structure, the treatment of a historic window and the design of a new one are therefore very important considerations.

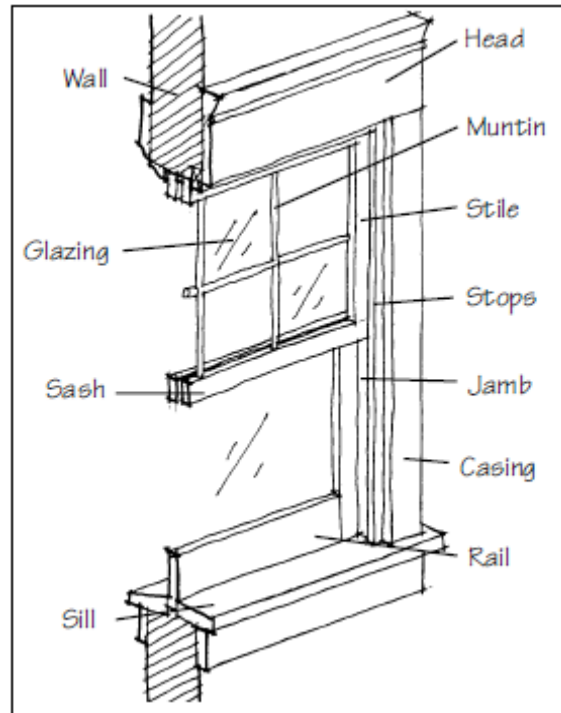

Typical double-hung window components.

Window Types

Window types typically found in historic structures in the Mansion and Capitol Areas include:

- Casement** - Hinged windows that swing open, typically to the outside.
- Display window** - Large plate glass windows on the ground level of commercial buildings.
- Double hung** - Two sash elements, one above the other. Both upper and lower sash slide within tracks on the window jambs.
- Fixed** - The sash does not move.
- Ornamental - or specialty** - Unusual shapes, such as a circular window; or distinct glazing patterns, such as a diamond-shaped, multi-pane window, which may be associated with distinct building styles. These may be fixed or operable.
- Single hung** - Two sash elements, one above the other. Only the lower sash moves.
- Transom** - An operable window above a door or above a commercial display window

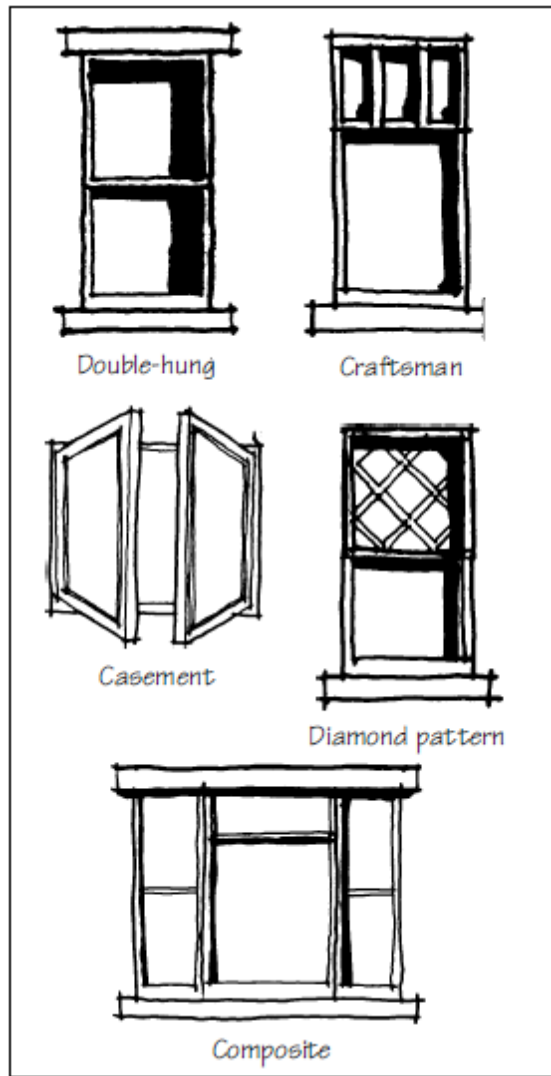

Typical window types on historic buildings in the District.

STANDARDS FOR HISTORIC WINDOWS

Treatment of Windows

- * **R3.1 Preserve the functional and decorative features of a historic window.**
 - Features important to the character of a window include its frame, sash, muntins, mullions, glazing, sills, heads and jambs. Repair frames and sashes rather than replacing them, whenever conditions permit.
- * **R3.2 Preserve the position, number and arrangement of historic windows in a building wall.**
 - Enclosing a historic window opening in a key character defining facade is inappropriate, as is adding a new window opening. This is especially important on primary facades where the historic ratio of solid-to-void is a character-defining feature.
 - Greater flexibility in installing new windows may be considered on rear walls.
- * **R3.3 Preserve the size and proportion of a historic window opening.**
 - Reducing an original opening to accommodate a smaller window or increasing it to receive a larger one are inappropriate measures.
 - Installing a "picture window" is inappropriate.
- * **R3.4 Preserve the historic ratio of window openings to solid wall on a primary facade.**
 - Significantly increasing the amount of glass on a character-defining facade will negatively affect the integrity of the structure.



Enclosing a historic window opening on a key character-defining facade destroys much of the building's historic character and is inappropriate.

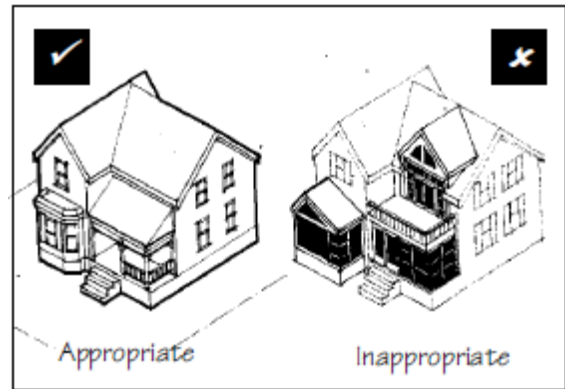

Preserve the historic ratio of window openings to solid wall on a primary facade.

Reducing an original opening to accommodate a smaller window or increasing it to receive a larger one are inappropriate measures.



Replacement Windows

*** R3.5 Match a replacement window to the original in its design.**

- If the original is double-hung, then the replacement window also should be double-hung or, at a minimum, appear to be so. Match the replacement also in the number and position of glass panes.
- Matching the original design is particularly important on key character-defining facades.

*** R3.6 In a replacement window, use materials that appear similar to the original.**

- Using the same material as the original is preferred, especially on character-defining facades. However, a substitute material may be considered if the appearance of the window components will match those of the original in dimension, profile and finish.
- The finish must appear similar to that of painted wood.
- Match, as closely as possible, the profile of the sash and its components to that of the original window.

Energy Conservation

R3.7 Use a storm window to enhance energy conservation rather than replace a historic window.

- Install a storm window on the interior, when feasible. This will allow the character of the original window to be seen from the public way.
- * • If a storm window is to be installed on the *exterior*, match the sash design of the original windows. A metal storm window may be appropriate if the frame matches the proportions and profiles of the original window. Match the color of the storm window sash with the color of the window frame; do not use a silvery metallic or reflective finish.



Match a replacement window to the original in its design.



If a storm window is to be installed on the exterior, match the sash design of the original window (as this one does).

Awnings and Shutters

* **R3.8 Awnings should be similar in character to those used traditionally.**

- First, an awning must be compatible with the building period and style.
- Fabric or metal may be used, and it should appear similar in texture and finish to awning materials that were used historically. A matte finish is appropriate, whereas a glossy or reflective finish is inappropriate.
- Operable frames are preferred, although rigid frames may be considered.
- The shape of the awning should reflect that of the opening. An arch shape should be used on an arched window, for example.
- Internal illumination is inappropriate.

* **R3.9 Shutters should appear similar to those used historically.**

- Shutters, or blinds, are appropriate in limited circumstances and only on specific styles of architecture.
- Shutters that are operable are preferred. At a minimum, they must fit the size of the opening and appear as if they function.

Security Bars

* **R3.10 Security bars should be designed to minimize visual impacts.**

- Designs should be simple in character.
- Locating security bars inside is preferred.

Maintenance for windows:

R3.11 To preserve a window:

- Maintain a good coat of paint on all exposed surfaces to protect the original material.
- Replace old glazing compound to secure the glass and reduce air leaks.
- Install new weather-stripping to further reduce air leaks.

SECTION 4-204 DOORS

Policy: The character-defining features of a historic door and its distinct materials and placement should be preserved. In addition, a new door should be in character with the historic building. This is especially important on primary facades.

Background

Doors, which are important character-defining features of historic structures, give scale to buildings and provide visual interest to the composition of individual facades. Some doors are associated with specific architectural styles. Many historic doors are noted for their materials, placement and finishes. Because an inappropriate door can severely affect the character of a historic house, one should be careful to avoid radical alteration of an old door and, if needed, to choose a new door that is appropriate to the design of the house.

Door Features

Important features include the door and its frame, the sill, head, jamb and any flanking windows or transoms.

Door Types

Door types found on historic structures in the Capitol and Mansion Area include:

Doorway with transom and sidelights - Typically a wooden door flanked by sidelights and topped with a rectangular transom.

Craftsman door - This type of door is distinctive for its thick wood plank design, often with upper glass lites divided by heavy muntins. Some Craftsman doors have a wood shelf bracket under the lites.

Glass paneled door - This type of door has a wide pane of glass in the upper portion of the door. Many Victorian era houses have glass paneled doors that are embellished with turned wood details and etched or stained glass.

Paneled door - Wooden door with raised panels.



The character-defining features of historic front doors should be preserved.



When a door is to be replaced, the new one should match the appearance of the original.

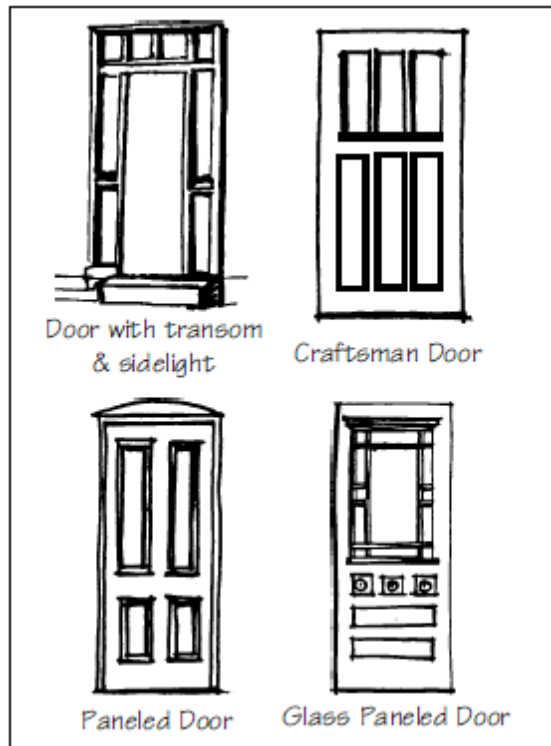

Typical front doors seen in the Mansion Area.

STANDARDS FOR HISTORIC DOORS

The standards for the treatment of doors apply primarily to front doors. Greater flexibility should be applied when replacing side and rear doors.

Treatment of Doors

- * **R4.1 Preserve the decorative and functional features of a primary entrance.**
 - These include the door, door frame, screen door, threshold, glass panes, paneling, hardware, detailing, transoms and flanking sidelights.
 - Avoid changing the position and function of original front doors and primary entrances.
 - Also maintain the size and shape of original door openings.
 - A wood framed screen door may be considered. Its design should be in character with the historic structure.
- * **R4.2 When a historic door is damaged, repair it and maintain its general historic appearance.**
 - Altering its size and shape is inappropriate.

Replacement Doors

- * **R4.3 When replacing a door, use a design that appears similar to the original or to one associated with the style of the house.**
 - Use materials that appear similar to that of the original. Wood is preferred.
 - A simple paneled door is appropriate for many building styles.
 - A flush face door is generally inappropriate for a front door.

Energy Conservation

R4.4 If energy conservation is a concern, consider using a storm door instead of replacing a historic entry door.

- Generally, wood storm doors are most appropriate.
- A metal storm door may be appropriate if it is simple in design and if the frame is anodized or painted so that raw metal is not visible.
- A storm door design should not obscure that of the main door behind it.

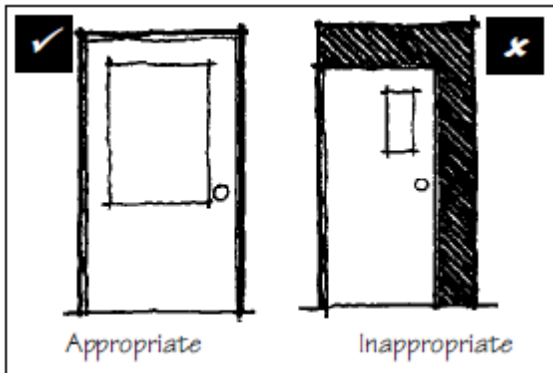

Maintain the historic door proportions.

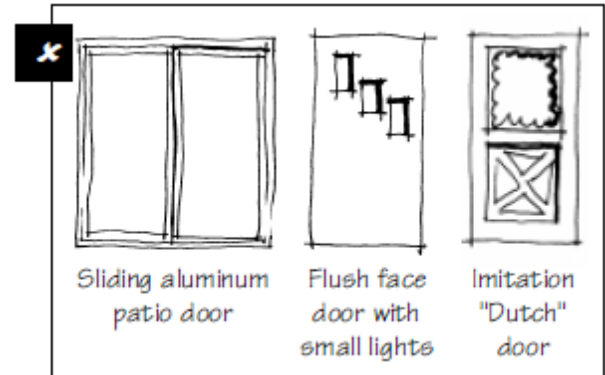

These are inappropriate replacement doors.

SECTION 4-205 PORCHES

Policy: Where a porch is a primary character-defining feature of a front facade, it should be maintained. If the original porch is missing, a replacement porch should be constructed to be in character with the original in terms of its scale, materials and detailing.

Background

Historically, porches were popular features in residential designs. They appear on simple vernacular structures as well as those with distinct architectural styles. From the Victorian houses of the late Nineteenth Century to the period revival and Craftsman homes of the early and middle Twentieth Century, designers integrated porches into their buildings. Earlier porches were almost exclusively constructed of wood, and while this material remained popular into the middle of the Twentieth Century, stone was used on some of the later houses in the Mansion Area.

A porch protects an entrance from rain and provides shade in the summer. It also provides a sense of scale to the façade and catches breezes in the warmer months, while providing a space for residents to sit and congregate. Finally, a porch connects a house to its context by orienting the entrance to the street.

Because of their historical importance and prominence as character-defining features, porches should be preserved and they should receive sensitive treatment during exterior rehabilitation.

Porch Features

While they do vary in character, most porches have a few elements in common:

- balustrades
- posts or columns
- architectural details
- hipped, gabled or shed roofs

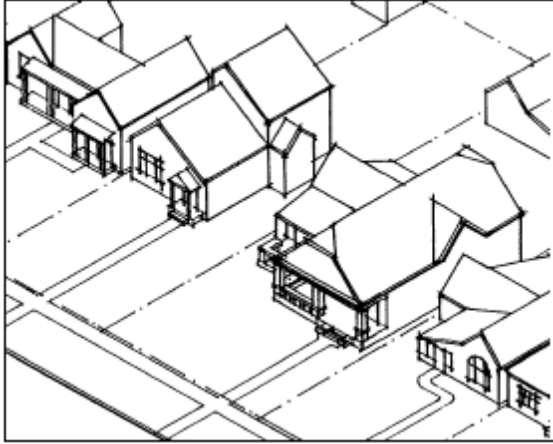

Porches serve various functions: they orient buildings to the street, link houses to their larger contexts and often are catalysts for personal interaction in the neighborhood.



Character-defining features of a porch should be preserved. These include balustrades, columns, brackets and steps, as well as foundations and flooring materials.

STANDARDS FOR HISTORIC PORCHES

Treatment of Porches

* **R5.1 Preserve an original porch.**

- Maintain the basic porch structure as well as its distinctive trim features.
- Replace missing posts and railings when necessary. Match the original character of porch columns. The proportions and spacing of balusters also should match the original.
- Unless it was used historically on a structure, wrought iron is inappropriate. Metal pipe also is inappropriate for porch columns.

* **R5.2 Avoid removing or covering historic materials and details on a porch.**

- Removing an original balustrade, for example, is inappropriate.

* **R5.3 Enclosing a historic front porch is inappropriate.**

- Enclosing a porch destroys the openness and transparency of the porch and is inappropriate. This applies to front porches and to significant side porches that are visible from the street.
- Enclosing a porch with glass is also inappropriate.
- Enclosing a subordinate side porch or one in the rear may be considered, if the enclosure maintains the height and shape of the historic roof and if the size of the openings and materials match those of the main structure. The Capitol Zoning District Commission will consider such approaches on an individual basis.
- A porch screen may be considered if the screen material does not cover or alter character defining porch features and is a fine, dark, non-metallic finish.



Preserve an original porch. Maintain the basic porch structure as well as its distinctive trim features.



When replacing missing porch railings, the proportions and spacing of balusters should match the original. This replacement matches the original.



The spacing of balusters on this replacement railing is inaccurate.

*** R5.4 If porch replacement is necessary, reconstruct it to match the original in form and detail.**

- Use materials similar to the original.
- The height of the railing and the spacing of balusters should appear similar to those used historically.
- Speculative construction of a porch is discouraged. Avoid applying decorative elements that are not known to have been used on such houses.
- If no evidence of the historic porch exists, a new porch may be considered that is similar in character to those found on comparable buildings in the neighborhood.



Preserve original porch features. Patch and repair significant features rather than replace.



The porch in the top photograph has experienced inappropriate alteration; metal posts have replaced original wood piers. In the case that adequate documentation is not available for reconstruction, consulting houses of similar character and age is appropriate.

R5.5 Maintenance for porches:

- Maintain drainage off of the main roof of the house, as well as off the roof of the porch.
- Channel water away from the foundation of the porch.
- Maintain a good coat of paint on all exposed wood surfaces.

SECTION 4-206 ARCHITECTURAL DETAILS

Policy: Architectural details help establish a historic building's distinct visual character; thus, they should be preserved whenever feasible. If architectural details are damaged beyond repair, their replacement, matching the original detailing, is recommended.

Background

Architectural details add visual interest, distinguish certain building styles and types, and they often showcase superior craftsmanship and architectural design. Features such as window hoods, brackets, and columns exhibit materials and finishes that are associated with particular styles, and therefore their preservation is important. Where replacement is required, one should remove only those portions that are deteriorated beyond repair.

Materials for Replacement Details

Using a material to match that employed historically is always the best approach. However, a substitute material may be considered for a detail when it appears similar in composition, design, color and texture to the original.

In the past, substitute materials were employed as cheaper, quicker methods of producing architectural features. Many of these historic "substitutes" are now referred to as *traditional* materials. Just as these historic substitutes offered advantages over their predecessors, many new materials today hold promise. However, these substitute materials should not be used wholesale, but only when it is absolutely necessary to replace original materials with stronger, more durable substitutes. In *Preservation Brief 16*, entitled *The Use of Substitute Material*, the National Park Service comments that "some preservationists advocate that substitute materials should be avoided in all but limited cases. The fact is, however, that substitute materials are being used more frequently than ever. They can be cost-effective, can permit the accurate visual duplication of historic materials, and last a reasonable time."

Substitute materials may be considered when the original is not easily available, where the original is known to be susceptible to decay or where maintenance may be difficult (such as on a church spire).

Another factor which may determine the appropriateness of using substitute materials for architectural details is on their location and degree of exposure. For example, lighter weight materials may be inappropriate for an architectural detail that would be exposed to intense wear. In this case, it may be wise to avoid using a fiberglass column on a front porch where it may be accidentally damaged. Conversely, the use of fiberglass to reproduce a cornice on a second story may be successful.



Decorative clapboard siding, multi-paned windows, chimney trim and a hooped metal fence are among the design details that contribute to the character of this property.

STANDARDS FOR HISTORIC DETAILS

Preservation of Architectural Details

* **R6.1 Avoid removing or altering significant architectural details.**

- Porches, turned columns, brackets and jigsaw ornaments are examples of architectural features which should be preserved.

* **R6.2 Avoid adding elements or details which were not part of the historic design.**

- For example, details such as decorative millwork or shingles should not be added to buildings if they were not original features of the structure.

* **R6.3 Protect and maintain significant stylistic elements.**

- Distinctive stylistic features and examples of skilled craftsmanship should be treated with sensitivity.
- The best preservation procedure is to maintain historic features from the outset so that intervention is not required.
- Employ treatments such as rust removal, caulking, limited paint removal and reapplication of paint.

R6.4 Use approved technical procedures for cleaning, refinishing and repairing architectural details.

- When choosing preservation treatments, use the gentlest means possible that will achieve the desired results.

R6.5 Minimize intervention with historic elements.

- Maintain character-defining features. Repair only those features that are deteriorated. Finally, replace only those features that are beyond repair.
- Patch, piece-in, splice, consolidate or otherwise upgrade the existing material, using recognized preservation methods whenever possible.

* **R6.6 When disassembly of an historic element is necessary for its restoration, use methods that minimize damage to the original materials.**

- When disassembly of an historic feature is required in a restoration procedure, document its location so it may be repositioned accurately. Always devise methods of replacing the disassembled materials in their original configuration.



Window frames, brackets, molding and strapwork are examples of architectural features that contribute to the historic significance of a property which should be preserved.



Features such as eave details often exhibit materials and finishes associated with particular styles, and therefore their preservation is important.

Replacement of Architectural Details

* **R6.7 Replacement of missing elements may be included in repair activities.**

- Replace only those portions that are beyond repair.

* **R6.8 Replace missing original features in kind.**

- Use the same kind of material as the original.
- If substitute materials must be used, then they must convey the visual appearance of the original material in form and design.
- The design should be substantiated by physical or pictorial evidence to avoid creating a misrepresentation of the building's genuine heritage.
- Replacement details should match the original in scale, proportion, finish and appearance.

* **R6.9 When reconstruction in kind is impossible, developing a compatible new design that is an interpretation of the original is appropriate.**

- This is appropriate when inadequate information exists to allow for an accurate reconstruction of missing features.
- The new element should relate to comparable features in general size, shape, scale and finish.

• For primary residential structures, details may be adapted from similar houses within the neighborhood, when there is evidence that a similar element once existed. For example, where "scars" on the exterior siding suggest the location of decorative brackets but no photographs exist of their design, then designs for historic brackets on historic houses that are clearly similar in character may be used as a model.

Where replacement of a detail is required, one should remove only those portions that are deteriorated beyond repair.

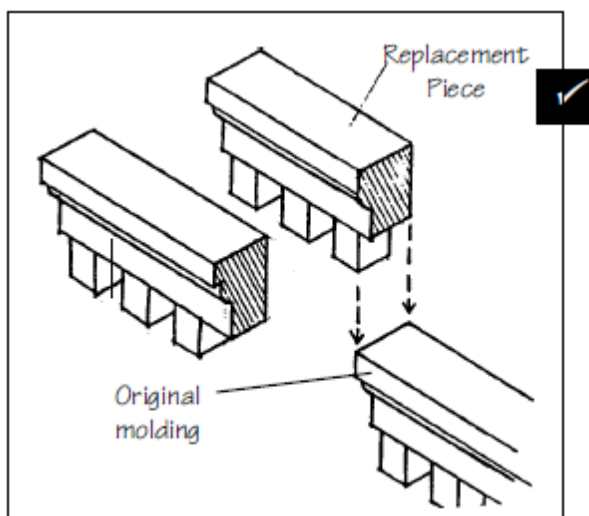

Distinctive stylistic features and examples of skilled craftsmanship should be treated with sensitivity. The best preservation procedure is to maintain historic features from the outset so that intervention is not required. Employ treatments such as rust removal, caulking, limited paint removal and reapplication of paint.

SECTION 4-207 ROOFS

Policy: The character of a roof should be preserved, including its form and materials, whenever feasible.

Background

The character of the roof is a major feature for most historic structures. When repeated along the street similar roof forms contribute to a sense of visual continuity for the neighborhood. In each case, the roof pitch, its materials, size and orientation are all distinct features that contribute to the character of a roof.

Roof Deterioration

The roof is a building's main defense against the elements. When the roof begins to experience failure, many other parts of the house also may be affected. For example, a leak in the roof may lead to damage of attic rafters or even wall surfaces. Common sources of roof leaks include:

- Cracks in chimney masonry
- Loose flashing around chimneys and ridges
- Loose or missing roof shingles
- Cracks in roof membranes caused by settling rafters

These problems should be promptly addressed to prevent further deterioration.

Roof Form

In repairing or altering a historic roof it is important to preserve its original character. For instance, one should not alter the pitch of the historic roof, the perceived line of the roof from the street or the orientation of the roof to the street. The historic depth of the overhang of eaves, which often is a key feature of the style of the house, also should be preserved.

Typical Roof Types

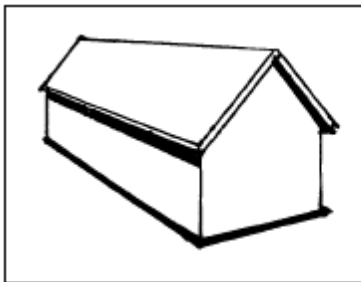

Gabled roof

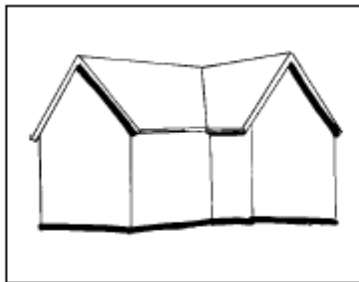

Cross-Gabled roof

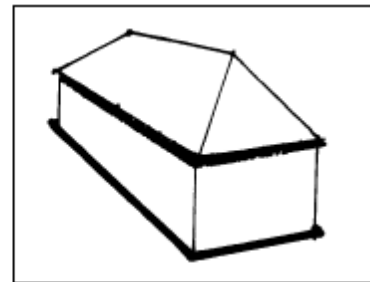

Hipped roof

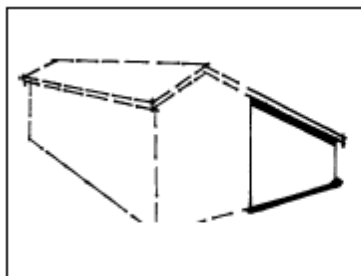

Shed roof

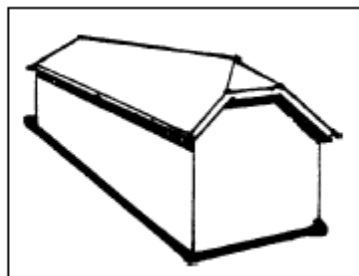

Clipped Gable

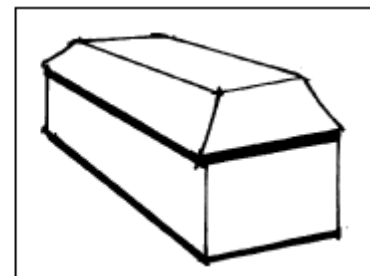

Mansard roof

STANDARDS FOR HISTORIC ROOFS

Treatment of Roofs

* **R7.1 Preserve the original roof form.**

- Avoid altering the angle of a historic roof. Instead, maintain the perceived line and orientation of the roof as seen from the street.
- Also retain and repair roof detailing. For example, preserve and restore original built-in gutters where they exist.

* **R7.2 Preserve historic eave depths.**

- Shadows created by traditional overhangs contribute to one's perception of the building's historic scale and, therefore, these overhangs should be preserved. Cutting back roof rafters and soffits or in other ways altering the traditional roof overhang are inappropriate.

Roof Additions

* **R7.3 When planning a rooftop addition, preserve the overall appearance of the original roof.**

- An addition should not interrupt the original ridgeline.
- See also the Standards for Building Additions in this article.

* **R7.4 Minimize the visual impacts of skylights and other rooftop devices.**

- Skylights or solar panels should be installed in a manner that will not interrupt the plane of the historic roof. Such features should be placed below the ridgeline.
- Flat skylights or solar panels that are flush with the roof plane may be considered on the rear and sides of the roof.

• Locating a skylight or a solar panel on a roof plane facing a public street should be avoided. If a solar panel must be located on a roof plane facing a street, it should be designed to minimize glare and reflectivity. The Capitol Zoning District Commission will consider such requests on an individual basis.

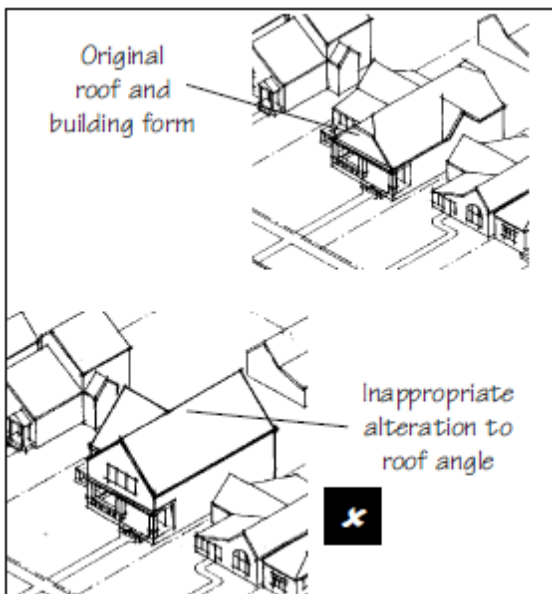

Preserve the original roof form. Avoid altering the angle of a historic roof. Instead, maintain the perceived line and orientation

Preserve the original historic eave depth.



Materials

When planning a reroofing project, pay special attention to neighboring structures, which can provide insight into the types of roofing materials that are appropriate for the neighborhood. In general, new roofing materials should be chosen based on their compatibility with the district, as well as their overall performance.

* **R7.5 Preserve original roof materials.**

- Avoid removing historic roofing material that is in good condition.
- Specialty materials, such as tile or slate, should be replaced in kind.

* **R7.6 Preserve significant design features of historic roofs.**

- For example, special decorative patterns, trim elements and finishes should be preserved.

* **R7.7 New or replacement roof materials should convey a scale and texture similar to those used traditionally.**

- When replacement is necessary, use materials that are similar to the original in both style as well as physical qualities and use a color that is similar to that seen historically.
- Composite shingles are appropriate for most building types in the Mansion Area.
- Roof materials should be earth tones and have a matte, non-reflective finish.
- When choosing a roof replacement material, the architectural style of the structure should be considered.

* **R7.8 Avoid using conjectural materials or features on a roof.**

- For example, adding a widow's walk (an ornate railing around the roof ridge) on a house where there is no evidence that one existed creates a false impression of the home's original appearance and is inappropriate.

Preserve significant design features of historic roofs. For example, special decorative patterns, trim elements and finishes should be preserved. Specialty materials, such as tile or slate, should be replaced in kind.



R7.9 Maintenance for roofs:

- Maintain gutters and downspouts in good condition.
- Keep gutters and downspouts free from debris to ensure proper drainage.
- Patch holes in gutters and downspouts to keep water from seeping onto walls and foundations.
- Install gutters in a manner that is not detrimental to historic building materials.

SECTION 4-208 ADDITIONS

Policy: If a new addition to a historic building is to be constructed, it should be designed such that the early character is maintained. Older additions that have taken on significance also should be considered for preservation.

Background

Many historic buildings have experienced additions over time as the need for additional space has occurred. In some cases, an owner would add a wing for a new bedroom, add on or fill in a rear porch, or expand the kitchen. An early addition typically was subordinate in scale and character to the main building. The height of the addition was usually positioned below that of the main structure, and it often was located to the side or rear, such that the primary facade remained predominate. An addition was often constructed of materials that were similar to those in use historically. This tradition of adding onto historic buildings is anticipated to continue. It is important, however, that new additions be designed in such a manner that they preserve the historic character of the primary structure.

Basic Principles for New Additions

When planning an addition to a historic building or structure, one should minimize any negative effects that may occur to the historic building fabric as well as to its character. While some destruction of historic materials is almost always a part of constructing an addition, such loss should be minimized. Locating an addition such that existing side or rear doors may be used for access, for example, will help to minimize the amount of historic wall material that must be removed.

The addition also should not affect the perceived character of the building. In most cases, loss of character can be avoided by locating the addition to the rear. The overall design of the addition also must be in keeping with the design character of the historic structure. At the same time, it should be distinguishable from the historic portion, such that the evolution of the building can be understood. This can be accomplished in a subtle way, with a jog in the wall planes or by using a trim board to define the connection.

Keeping the size of the addition small in relation to the main structure also will help minimize its visual impacts. If an addition must be larger, it should be set apart from the historic building and connected with a smaller linking element. This will help maintain the perceived scale and proportion of the historic portion.

DESIGN STANDARDS FOR ADDITIONS

Existing Additions

- * **R8.1 Preserve an older addition that has achieved historic significance in its own right.**
 - An example of such an addition may be a summer kitchen that was attached to the primary building early in its history. Such an addition is usually similar in character to the original building in terms of materials, finishes and design.
- * **R8.2 A more recent addition that is not historically significant may be removed.**
 - For example, a sun porch recently may have been added and has not achieved historic significance.

New Additions

- * **R8.3 Design a new addition such that one's ability to interpret the historic character of the building is maintained.**
 - A new addition that creates an appearance inconsistent with the historic character of the building is inappropriate.
 - An addition that seeks to imply an earlier period than that of the building also is inappropriate. An addition that seeks to imply an inaccurate variation on the historic style should be avoided.
 - An addition that covers historically significant features is inappropriate as well.
- * **R8.4 Design a new addition to be recognized as a product of its own time.**
 - An addition should be made distinguishable from the historic building, while also remaining visually compatible with these earlier features.
 - A change in setbacks of the addition from the historic building, a subtle change in material, or a differentiation between historic and more current styles are all techniques that may be considered to help define a change from old to new construction.
- * **R8.5 On a new addition, use exterior materials that are compatible with the historic materials of the primary building.**
 - Appropriate primary building materials include wood, brick and stone.
 - Foundations also were typically constructed of brick. Using brick or stone, similar to that employed historically, is preferred.
 - See also the discussion of specific building types and styles in Appendix C.
- * **R8.6 Design an addition to be compatible in size and scale with the main building.**
 - Place an addition at the rear of a building or set it back from the primary facades in order to allow the original proportions and character to remain prominent. A minimum setback of 10 feet is recommended. This will allow the original proportions and character to remain prominent.
 - Keep the addition visually subordinate to the historic building.
 - If it is necessary to design an addition that is taller than the historic building, set it back substantially from significant facades and use a "connector" to link it.
 - Locating an addition at the front of a structure is inappropriate.

* **R8.7 Roof forms should be similar to those of the historic building.**

- Typically, gable, hip and shed roofs are appropriate.
- Flat roofs are generally inappropriate.

Rooftop Additions

* **R8.8 When constructing a rooftop addition, keep the mass and scale subordinate to the scale of the historic building.**

- An addition should not overhang the lower floors of the historic building in the front or on the side.

* **R8.9 Set a rooftop addition back from the front of the building.**

- This will help preserve the original profile of the historically significant building as seen from the street.



Do not construct a new addition that will hinder one's ability to interpret the historic character of the building or structure. This addition obscures the front porch, for example, and is inappropriate.



An addition should be compatible in form, scale and materials with the historic building. Using a "connector" to link the new construction with the original is one means of maintaining the character of the primary structure.



A new porch serves as the connector in the photo above, linking the new construction with the original.

* **R8.10 The roof form and slope of a new addition should be in character with the historic building.**

- If the roof of the historic building is symmetrically proportioned, the roof of the addition should be similar.
- Eave lines on the addition should be similar to those of the historic building or structure.
- Dormers should be subordinate to the overall roof mass and should be in scale with historic ones on similar historic structures.

Deck and Pool Additions

R8.11 Minimize the appearance of any deck or swimming pool.

- Decks should be subordinate in terms of scale and detailing.
- Locate decks and swimming pools behind the primary structure so they are not visible from the street.

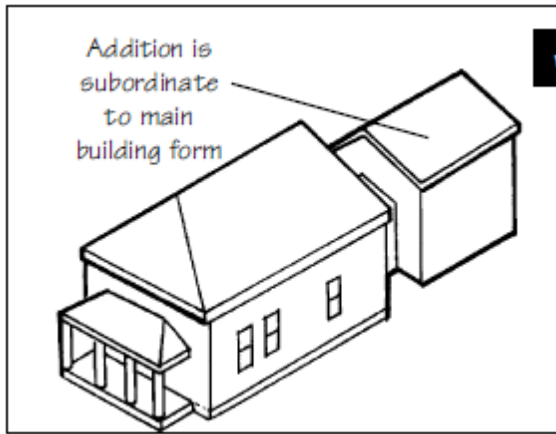

Place an addition at the rear of a building or set it back from the front to minimize the visual impact on the historic structure and to allow the original proportions and character to remain prominent.



When constructing a rooftop addition, keep the mass and scale subordinate to the scale of the historic building. In this case, a dormer is added to the side, preserving the character of the front of the building.

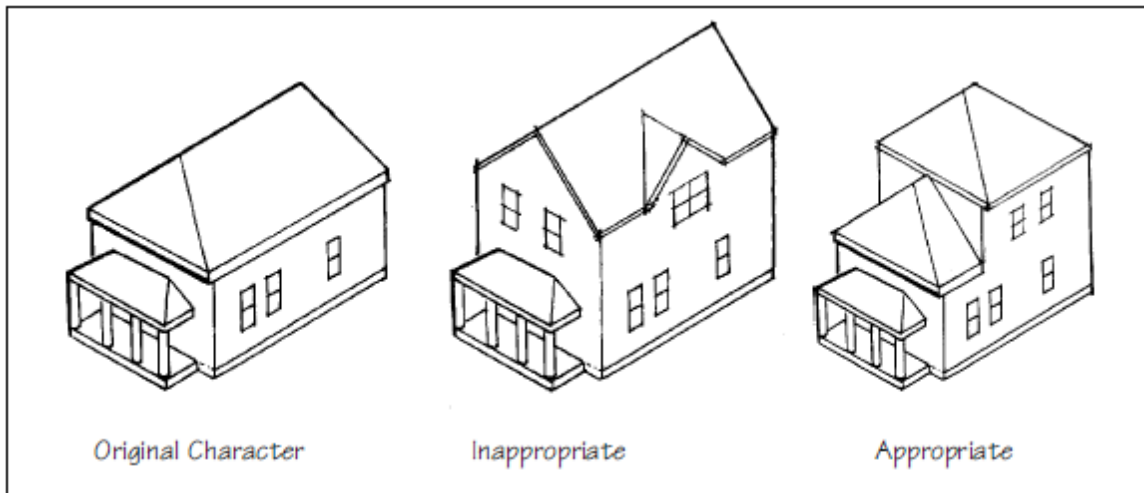

Set a rooftop addition back from the front of the building. A "pop-top" addition such as that in the sketch in the center overwhelms the historic house and obscures its original character.

SECTION 4-209 SECONDARY STRUCTURES

Policy: Historic secondary structures should be preserved. This may include maintaining the structure in its present condition, rehabilitating it or executing an adaptive use so that the secondary structure supports a new function.

Background

Secondary structures include garages, carriage houses and sheds. Traditionally these structures were important elements of a residential site. Because secondary structures help interpret how an entire lot was used historically, their preservation is strongly encouraged. Studies of secondary structures indicate that the garage has been a natural evolution from the barn and carriage house, structures which were built to shelter transportation. When the automobile arrived, it often was stored in the carriage house. Later, however, as the automobile became prevalent, the garage took on a building form of its own. The garage was detached from the house and located a distance from it, usually along an alley, if one existed. Originally, garage doors were similar to those seen customarily on barns— double doors that slide horizontally. The use of double doors eventually gave way to a vertically rolling garage door, which was the prototype for the electric garage door.

Primary Materials

Many of the materials that have been used traditionally in secondary structures are those employed in the construction of primary buildings. Materials are addressed in the preceding chapters. In preserving or rehabilitating secondary structures, it is important that the character-defining materials be preserved.

DESIGN STANDARDS FOR SECONDARY STRUCTURES

Preserving Secondary Structures

- * **R9.1 The preservation of an existing secondary structure is encouraged.**
 - When treating a historic secondary building, respect its character-defining features such as primary materials, roof materials, roof form, historic windows, historic doors and architectural details.
 - Avoid moving a historic secondary structure from its original location.
 - If the secondary structure does not date from the period of significance, then its preservation is optional.
- * **R9.2 If an existing secondary structure is beyond repair, then replacing it in-kind is encouraged.**
- * **R9.3 A new secondary structure should be in character with those seen traditionally.**
 - The building should be subordinate in scale to the primary structure.
 - It should be located to the side or rear of the primary structure.
 - See also the standards for new construction and for site design.



Secondary structures include garages, carriage houses or sheds. Traditionally, these structures were important elements of a residential site.

Secondary structures should be located to the side or rear of the primary structure.

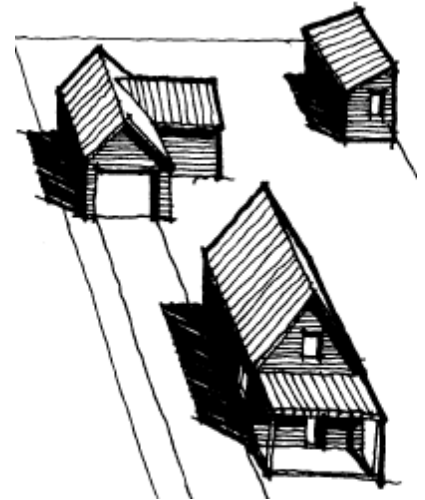

SECTION 4-301 INTERPRETATION OF TERMS RELATED TO COMPLIANCE

These definitions apply to terms related to compliance with the Standards in this article.

Appropriate - In some cases, a stated action or design choice is defined as being “appropriate” in the text. In such cases, by choosing the approach referred to as “appropriate,” the reader will be in compliance with the standard. However, in other cases, there may be an approach that is not expressly mentioned in the text that also may be deemed “appropriate” by the CZDC.

Case-by-case – Several standards describe treatments that were not commonly employed historically, but may nevertheless be suitable for some properties. Such approaches will be approved when it is demonstrated to the Commission’s satisfaction that the proposed work will not detract from the historic integrity of the property or surrounding properties.

Consider - When the term “consider” is used, a design suggestion is offered to the reader as an example of one method of how the design standard at hand could be met. Applicants may elect to follow the suggestion but may also seek alternative means of meeting it. In other cases, the reader is instructed to evaluate the ability to take the course recommended in the context of the specific project.

Context - In many cases, the reader is instructed to relate to the context of the project area. The “context” is comprised of those properties and structures adjacent to, and within the same block, as the proposed project.

Historic - In general, a historic property is one that is at least 40 years old or older and largely unchanged. Some properties less than 40 years old may also be considered historic if they are of exceptional significance. The CZDC is especially concerned with those properties that are associated with significant people or events or convey a character of building and design found during the District’s period of significance, roughly 1880-1940. Note that in some cases, a CZDC-designated property may also be listed in the National Register of Historic Places.

Inappropriate - Inappropriate means impermissible. When the term “inappropriate” is used, the relevant design approach shall not be allowed. For example, one standard states: “A new addition that creates an appearance inconsistent with the historic character of the building is inappropriate.” In this case, a design out of character with the historic building would not be approved.

Integrity - A building's "integrity" is a measure of the wholeness or quality of all of the historic features which make up the building. A building that has been added to and had features removed is said to have had its integrity compromised.

Primary Facade - The primary facade is the principal elevation of a building, usually facing the street or other public way.

Shall - Where the term “shall” is used in a standard, compliance is required.

Should - If the term “should” appears in a standard, compliance is required, but may be waived, if it is demonstrated to the Commission’s satisfaction that such a waiver will not adversely affect the historic integrity of the property or the surrounding neighborhood.

Standard - In the context of this document, a “standard” is a requirement that must be met, in order to be in accordance with the intent of the preservation principles.

Streetscape - All of the elements which make up a block— sidewalks, curbs, trees, front yards, fences, buildings, signage and lighting—contribute to the existence of a "streetscape." These elements all are important to the identification of the neighborhood.

SECTION 4-302 THE SECRETARY OF THE INTERIOR'S STANDARDS FOR THE REHABILITATION OF HISTORIC PROPERTIES

These standards are widely recognized throughout the US as the foundation for state and local preservation standards and guidelines. The Capitol Zoning District Commission adopts these standards by reference.

- 1. A property will be used as it was historically or be given a new use that requires minimal change to its distinctive materials, features, spaces, and spatial relationships.*
- 2. The historic character of a property should be retained and preserved. The removal of historic materials or alteration of features, spaces, and spatial relationships that characterize a property will be avoided.*
- 3. Each property will be recognized as a physical record of its time, place, and use. Changes that create a false sense of historical development, such as adding conjectural features or elements from other historic properties, will not be undertaken.*
- 4. Changes to a property that have acquired historic significance in their own right will be retained and preserved.*
- 5. Distinctive materials, features, finishes, and construction techniques or examples of craftsmanship that characterize a property will be preserved.*
- 6. Deteriorated historic features will be repaired rather than replaced. Where the severity of deterioration requires replacement of a distinctive feature, the new feature will match the old in design, color, texture, and, where possible, materials. Replacement of missing features should be substantiated by documentary and physical evidence.*
- 7. Chemical or physical treatments, if appropriate, will be undertaken using the gentlest means possible. Treatments that cause damage to historic materials will not be used.*
- 8. Archeological resources will be protected and preserved in place. If such resources must be disturbed, mitigation measures will be undertaken.*
- 9. New additions, exterior alterations, or related new construction will not destroy historic materials, features, and spatial relationships that characterize the property. The new work will be differentiated from the old and will be compatible with the historic materials, features, size, scale and proportion, and massing to protect the integrity of the property and its environment.*
- 10. New additions and adjacent or related new construction will be undertaken in such a manner that, if removed in the future, the essential form and integrity of the historic property and its environment would be unimpaired.*

Design for alterations and additions to existing properties should not be discouraged when such alterations and additions do not destroy significant historical, architectural or cultural material. Such design should be compatible with the size, scale, color, material and character of the property, neighborhood and environment.

SECTION 4-303 ARCHITECTURAL STYLES OF THE CAPITOL AND MANSION AREAS

This section provides an overview of the architectural styles found in the Capitol and Mansion Areas. Its purpose is to help property owners understand the historic character of their buildings so that well-informed decisions on design issues can be made when work is planned. In addition, sometimes the design standards make reference to the characteristics of styles that are discussed here, so this information also can assist property owners in understanding and applying the standards. Although an effort has been made to discuss all of the major styles and their variations that appear in the Capitol and Mansion Areas, there are buildings that do not fall into these categories and will have to be examined on a case-by-case basis.

Of the architectural styles that were most popular in Little Rock during the late 19th and early 20th centuries—Italianate, Queen Anne, Colonial Revival and Neoclassical, Craftsman, English Revival—the Mansion Area contains many of the city’s premier examples. Some three-quarters of the Mansion Area’s buildings were constructed from the 1880s to the 1920s, and during much of that time, the area was the neighborhood of choice for Little Rock’s prominent and affluent families. Consequently, the Mansion Area not only contains a large number of historic houses, it also contains many of Little Rock’s most significant historic houses.

Not all of the Mansion Area’s historic houses were built for affluent residents, however. In fact, one of the Mansion Area’s strengths is the diversity of its historic housing stock. Not only are several different architectural styles present, but each of these styles typically is represented by houses of many different sizes. From modest cottages to elegant mansions, the Mansion Area historically accommodated a diverse population, a tradition that continues today.

In the Capitol Area, however, nearly all of the original residential fabric was lost in the second half of the 20th Century. Beginning around 1960, much of the largely working-class neighborhood (sometimes called “Northgate”) that formerly surrounded the State Capitol and Union Station was replaced with suburban-style office buildings. The few remaining original houses can generally be categorized with the same historic style descriptions used in the Mansion Area. The Capitol Area features a number of historic commercial structures, including some strong examples of Mid-Century styles.

Italianate (1840-1885 in U. S.; 1860s-1885 in Little Rock)

The Italianate style came to the United States from England and grew popular as a picturesque alternative to the neoclassical Greek Revival style that prevailed during the early 19th century. The first Italianate residence in the U. S. was built in the late 1830s. It was an “Italian Villa”, based on the architecture of Italian farmhouses. Beginning in the 1840s, Italian Villa designs by architect Alexander Jackson Davis were widely circulated in pattern books written by Andrew Jackson Downing, a landscape gardener and architectural critic. These books helped popularize the Italian Villa style. Two other Italian styles also became popular in the United States: Renaissance Revival, a formal style derived from the architecture of large and elaborate city residences, the palazzos of Renaissance Italy; and Italianate, which encompassed all other Italian-influenced designs.

Characteristics

- widely overhanging eaves with decorative brackets
- tall, narrow windows and doors topped by segmental or full arches
- heavy wood moldings on door and window openings
- square porch columns with chamfered edges and brackets at the top
- low-pitched, hipped roofs

Houses with some Italianate decorative details were built in Little Rock before the Civil War, but it was not until after the war that full-fledged Italianate houses appeared in the city. Most fell into the catch-all “Italianate” category, although a few Italian Villas are known to have existed (all are gone now). Nationally, the Italianate style was losing popularity by the mid-1870s, but it continued to be the predominant style in Little Rock into the early 1880s.

No “high style” Italianate houses were built in the neighborhood that grew up around the Blind School (now location of the Arkansas Governor’s Mansion), mainly because the style was waning by the time development of the neighborhood got underway in the 1880s. The oldest house in the Mansion Area, the “Old” Hotze House (1869), shows the influence of the Italianate style in its porch columns and bracketed eaves, but it has the symmetrical floorplan—a central hall with two rooms on either side—that was typical of antebellum Greek Revival houses.

Italianate detailing can also be seen on several of the traditional commercial style buildings seen on South Main Street, and scattered throughout the District.

The Old Hotze House is one of the few houses in the Mansion Area with Italianate features. (Photo: ca. 1960)



Where the Mansion Area overlaps four blocks of the MacArthur Park Historic District, a neighborhood that is older than the one surrounding the Governor's Mansion, there are three major Italianate houses: the Villa Marre (1881), the Garland-Mitchell House (1873-74), and the Terry-Jung House (1881). These are the exceptions to the rule in the Mansion Area, where few other houses can be considered truly Italianate. Besides the Hotze House, the Pierce House (c. 1881) at 1704 Center Street is the only house in the Governor's Mansion neighborhood with the bracketed eaves characteristic of the Italianate style. The Robertson-Kilpatrick Cottage (c. 1881) at 1800 Gaines Street lacks brackets on its eaves but has the tall, narrow proportions and hipped roof of the Italianate style, as well as bracketed porch columns. Behind a Colonial Revival porch added in the early 20th century, the two-story Wilson-Mehaffy House (1883) at 2102 Louisiana Street also is a tall, narrow, hipped-roofed Italianate without brackets. Though it has been altered considerably, the Stephens House (1880) at 2101 Main Street is another two-story, bracketless Italianate.

Traditional or Folk Victorian (1880s in Mansion Area)

After the "Old" Hotze House (and not counting the four block overlap with the MacArthur Park Historic District), the oldest houses in the Mansion Area date from the early 1880s. Most of them are traditional, one-story, L-shaped cottages with ornamentation consisting only of a decorative vent in the front-facing gable and decorative detailing -- turned spindles or flat, jigsaw-cut trim -- their porches.

Based on traditional building forms but embellished with trim made possible by newfangled woodworking machinery, these houses sometimes are described as Folk Victorian. The Marre Cottage (c. 1885) at 1315 Center Street is a good example.

Some traditional cottages in the Mansion Area nearly cross the line into the Italianate style by incorporating bay windows with tall, narrow Italianate proportions into their designs. Examples are the Frese Cottage (c. 1882) at 1614 Louisiana Street and its next-door neighbor, the Tabor-Patterson House (c. 1885), which also has Italianate-style porch columns. In addition, the Mansion Area has a few two-story traditional or Folk Victorian houses, such as the Dickinson House (c. 1880) at 523 West 15th Street, which has a later Colonial Revival porch.

Characteristics

- frame construction
- L-shaped—a.k.a. "gable front and wing"—plan with porch in the L formed by the gable and wing
- decorative vent(s) in gable(s)
- decorative wooden porch trim, turned and/or jigsaw-cut
- bay windows (sometimes)

An example of Folk Victorian features



Queen Anne (1875-1910 in U. S.; 1885-1910 in Little Rock)

The Queen Anne style originated during the mid-19th century in England and arrived in the United States in the mid-1870s. Named for the monarch who ruled England from 1702 to 1714, English Queen Anne-style houses supposedly were inspired by the transitional architecture of the early 1700s, when classical decorative ornament was applied to buildings that retained earlier asymmetrical, medieval forms.

Characteristics

- irregular, asymmetrical floorplans, often including turrets
- a variety of surface textures: brick, stone, stucco, clapboard, decorative shingles
- small-paned windows, sometimes stained glass
- prominent paneled brick chimneys
- multi-gabled roofs, sometimes with dormers
- spindlework trim on porches and gables

Most of Little Rock's best examples of the Queen Anne style are located in the Mansion Area. The style was popular in Little Rock from the mid-1880s until shortly after the turn of the century, years that correspond with the Mansion Area's heyday. The first large architect-designed house built in the neighborhood, the W. J. Turner House (1884-85) at 1722 Center Street, was Queen Anne in style (now known as the Turner-Back House, the house subsequently underwent a Craftsman remodeling), and scores of excellent examples of the style—both large and small—followed. More than one hundred of these Queen Anne houses still are standing.

A small elite group of Queen Annes are the ones constructed of brick, an expensive building material in the late 19th century and much more rarely used in Little Rock than frame. The Hornibrook House (1888) at 2120 Louisiana Street, designed by the architectural firm of Orlopp and Kusener, arguably is Little Rock's best remaining example of the Queen Anne style, but other brick Queen Annes --especially the Dibrell House (1892) at 1400 Spring Street and the Turner-Ledbetter House (1891-92) at 1700 Louisiana Street -- follow closely on its heels.

The Mansion Area's much-more-numerous frame Queen Annes come in all shapes and sizes. The Ragland House (c.1890) at 1617 Center Street and the Hemingway House (c.1893) at 1720 Arch Street, both designed by Charles L. Thompson, represent the large, architect-designed end of the spectrum. In the middle are both smaller two-story homes such as the Frank Gibb House (c. 1890) at 1858 Arch Street, designed by architect Frank Gibb for himself, and one-story versions of the Queen Anne style, such as the E. G. Thompson Cottage (c. 1895) at 1806 Gaines Street. At the most modest end of the spectrum are cottages that are considered Queen Anne by virtue of their rooflines (usually hipped with lower cross gables), gables sheathed in decorative shingles, and spindlework porches. One example is the Thompson-Daniels Cottage (c. 1892) at 2009 Spring Street.

The Crawford House is an example of the Queen Anne style.



Neo-Classical features on the Second Frank Gibb House.



Colonial Revival (1880-present in U.S.; 1895-present in Little Rock); and Neoclassical (1895-present in U. S.; 1900-present in Little Rock)

The Philadelphia Centennial Exposition of 1876 is credited with having piqued Americans' interest in their colonial past. Within just a few years of the Exposition, architectural details copied from early English and Dutch houses in the eastern United States began to be incorporated into the design of new houses. Eighteenth century Georgian- and Adam (or Federal)-style houses most often served as the inspiration for Colonial Revival details, but other colonial styles, such as Dutch Colonial, also were copied. Especially during the early years of the Colonial Revival's popularity, details from various colonial-era styles were mixed freely and often were applied to houses that were Queen Anne in plan. Consequently, early Colonial Revival houses bear little resemblance to the real thing. After the turn of the century, the design of Colonial Revival houses began to be more accurately modeled after colonial prototypes. In particular, symmetrical floorplans became the rule of thumb.

Related to the Colonial Revival, and sometimes difficult to distinguish from it, is a style known as Neoclassical or Neoclassical Revival. Its origins are in the World's Columbian Exposition that was held in Chicago in 1893 -- the "White City" of monumental buildings that spawned the City Beautiful Movement and led to construction of Neoclassical public buildings throughout the United States (including the Arkansas State Capitol and Little Rock City Hall). Based on classical Greek and Roman architecture -- or, more accurately, on the Roman and Greek Revival styles that were popular in the United States during the late 18th and early 19th centuries -- Neoclassical houses often have two-story porticos and a more formal and/or monumental appearance than their Colonial Revival contemporaries. However, Neoclassical houses sometimes also incorporate details borrowed from the same styles, Georgian and Adam, that inspired the Colonial Revival. Consequently, distinguishing between Colonial Revival and Neoclassical can be a challenge.

Characteristics

- one-story entry porch with classical columns (Colonial Revival houses)
- two-story entry porch with classical columns (Neoclassical houses)
- Palladian windows (comprised of an arched window flanked on either side by narrower flat-topped windows)
- cornices ornamented with modillions or dentils
- porch and roof balustrades
- fanlights and sidelights
- small semi-circular windows (lunettes) in gables
- gabled, hipped, or gambrel roofs (a gambrel roof indicates a Dutch Colonial Revival design)

In the Mansion Area there are some 150 Colonial Revival or Neoclassical houses, including many of Little Rock's best examples of those styles, all built between 1895 and 1940. Those dating from the late 1890s -- all of which are Colonial Revival -- combine Queen Anne-style asymmetrical floorplans with details that are Colonial Revival. Beginning about 1900, larger homes with symmetrical floorplans began appearing, but transitional houses continued to be built until about 1910.

The one-story (or sometimes 1 1/2-story) examples of the transition from Queen Anne to Colonial Revival have come to be known locally as "Colonial Revival cottages." About fifty are located in the Mansion Area. The Burlingame House (1910) at 1409 Arch Street is a typical example. At the upper end of the scale is the Vinson House (1905) at 2123 Broadway, designed by Charles L. Thompson. Two-story transitional houses number about a dozen in the Mansion Area. An excellent brick example is the Kavanaugh House (1899) at 1854 Arch Street. An equally good example in frame is the Harrod House (c. 1895) at 2000 Broadway, a Charles L. Thompson design.

Many of the two-story Colonial Revival houses built in the Mansion Area after the turn of the century are "American Foursquares" with Colonial Revival ornamentation. The Foursquare is a form of house, rather than a style, that was widely used in the early 20th century. Foursquares typically are embellished with details borrowed from architectural styles popular at the time, especially Colonial Revival, Craftsman, and -- infrequently in Little Rock -- Prairie and Mission. These details are attached to a square, two-story house that has a hipped roof and a full-width, one-story porch. The Mansion Area has about twenty-five Foursquares with Colonial Revival details. Examples are the French-England House (1905) at 1700 Broadway, designed by Charles L. Thompson, and the Flinn House (c. 1906) at 1616 Spring Street.

Because development in the Mansion Area virtually stopped by the end of the 1920s, there are few examples of the more accurate copies of colonial-era architecture that became increasingly common as the 20th century progressed. One that does exist is the Judd House (c. 1924) at 307 West 17th Street, which is distinctly Georgian in inspiration.

The Neoclassical style arrived in the Mansion Area at the turn of the century with construction of one of the neighborhood's grandest homes, the "New" Hotze House at 1619 Louisiana Street. The house was constructed about 1900 by Peter Hotze, who had made a fortune in the cotton business. (His previous home, the "Old" Hotze House, is the Mansion Area's oldest.) This monumental brick residence was designed by Charles L. Thompson, and its two-story portico marks it as Neoclassical. Another imposing brick example of the Neoclassical style in the Mansion Area is the Gibb-Alzheimer House (c. 1906) at 1801 Arch Street. The twin Halliburton Houses (c. 1905) at 1601 and 1605 Center Street are frame examples of the Neoclassical style. Except for the Governor's Mansion (1947-50), construction of Neoclassical houses ended in the Mansion Area by World War I, but Colonial Revival houses continued to be built into the 1920s. Modern versions of these styles still are going up in new neighborhoods today.

The Classical Revival style was no less popular in the Capitol Area. The Smith Clinic building at 623 Woodlane, the Abrams House at 300 South Pulaski, and the Homard House at 1217 West Third all exhibit distinctly Neoclassical details. Both Union Station and the State Capitol itself are examples of the Classical Revival style employed on a monumental scale.

The Colonial Revival style is less well represented in the Capitol Area, though the Bosshardt House at 1222 West Capitol Avenue is a strong example.



The New Hotze House, one of the Mansion Area's grandest homes, is an example of the Neoclassical style.

Craftsman (1905-1930 in U. S.; 1910-1930 in Little Rock)

The Craftsman style in the United States evolved from the British Arts and Crafts Movement, a reaction against the excessive, often cheaply-made decoration of late-19th century buildings and furnishings. The Craftsman style -- as its name suggests -- emphasized good craftsmanship, as well as the use of natural materials. Craftsman-style architecture avoided applied ornamentation; rather, elements of the structure itself -- exposed beams and rafter ends, braces under eaves -- provided visual interest. California architects and brothers Charles Sumner Greene and Henry Mather Greene are credited with inspiring the Craftsman style in architecture, but a furniture-maker, Gustav Stickley, popularized Craftsman houses and furnishings through *The Craftsman*, a magazine that he published from 1901 to 1916.

One-story Craftsman houses are called "bungalows," a name borrowed from India. The average bungalow was a compact house -- living room, dining room, kitchen, two bedrooms, and a bath -- that suited the needs of working- and middleclass American families. As a result, bungalows were built by the thousands across the United States.

Characteristics

- broadly-pitched, gabled roofs
- expansive porches and/or terraces
- squat porch columns
- exposed structural elements: rafter ends, beams, braces
- "battered" or sloping foundation and/or porch columns
- use of natural materials: cobblestone, stucco, wooden shingles

Several of Little Rock's major Craftsman houses are found in the Mansion Area, which has a total of about 150 houses in that style. There are more two-story Craftsman houses in the Mansion Area than bungalows, a fact that attests to the affluence of the neighborhood during the early 20th century. The relative scarcity of bungalows in the Mansion Area also is attributable to the neighborhood's development being largely complete by the time bungalows were built in large numbers in Little Rock, something that occurred from about World War I through the 1920s.

The Keith House (1912) at 2200 Broadway, designed by Charles L. Thompson, is one of the city's best examples of the Craftsman style, although it also shows the influence of the Prairie style. The Cornish House (c. 1916) at 1800 Arch Street is another major Craftsman design, this one by Theo Sanders and with touches of the English Revival style.

More typical two-story Craftsman examples are the Farrell Houses (1914) at 2109, 2111, 2115, and 2121 Louisiana Street, all designed by Charles L. Thompson, and the Ault House (c. 1920) at 2017 Arch Street. Bungalows in the Mansion Area include the Beyerlein House (1916), a Charles L. Thompson design at 412 West 14th Street, and the more modest Doty-McAlpine House (c. 1911) at 1912 Center Street.

Also in the Mansion Area are a few American Foursquares with Craftsman details. One good example is the Isabella Gibb Rental House (c. 1910) at 1605 Arch Street.



This house has elements of the Craftsman style.

English Revival (or Tudor) (1890-present in U. S.; 1905- present in Little Rock)

Patterned after a variety of late medieval English models, the English Revival or Tudor style was introduced in the United States in the late-19th century. Most of the earliest examples were major architect-designed residences, in part because they were of masonry construction, which was expensive before improvements in masonry veneering techniques were made in the early 20th century. Due to the expense of masonry, more modest pre-1920 versions of the English Revival style sometimes used clapboard, shingles, or stucco -- none of which is "authentic," except that stucco could be combined with wood to create the look of half-timbering. These early English Revival houses also often were symmetrical in plan, another deviation from medieval models.

The English Revival style exploded in popularity in the 1920s, after masonry veneering became affordable. Large, rambling houses modeled after English manor houses were built in upscale suburban areas, while small "English cottages" lined streets in working- and middle-class neighborhoods.

Characteristics

- steeply-pitched, gabled roofs
- decorative half-timbering
- decorative stone- and/or brickwork
- prominent chimneys, sometimes with decorative chimney pots
- arched doorways
- casement windows, often with leaded, diamond-shaped panes

By the time the English Revival style was widely affordable, the Mansion Area's development was largely complete. Fewer than twenty English Revival houses are found in the area. However, one is of great architectural and historical importance. The Foster-Robinson House (c. 1905) at 2122 Broadway, designed by Frank Gibb, is thought to be the first English Revival-style house built in Little Rock. In addition, it is designated a National Historic Landmark because of its association with U. S. Senator Joe T. Robinson, its second owner.

The J. R. Vinson House (c. 1910) at 1868 Arch Street is the area's other pre-1920 example of the style and has the symmetrical plan typical of early English Revival houses. Examples dating from the 1920s include the Almand House (c. 1922) at 324 West 14th Street, designed by architect John Parks Almand for himself, and the Harris House (c. 1920) at 2018 Gaines Street, a stucco-clad cottage that also was designed by Almand. At 2020 Broadway, the Fred W. Terry House is a late example of the style, built in 1938.

Other Early Twentieth Century Styles (1900-1925 in Mansion Area)

Assorted early 20th century architectural styles, most of which never became widely popular in Little Rock, are represented by a group of a little more than a dozen houses in the Mansion Area. These include:

Egyptian Revival -- The Fordyce House (c. 1904) at 2115 Broadway is the lone and very unusual representative of the Egyptian Revival style. Egyptian Revival houses are exceedingly rare in the United States and usually date from the mid-19th century. Designed by Charles L. Thompson, this early 20th century version, with its papyrus-stalk porch columns and "battered" walls, may be the only one of its kind in the country.

Italian Renaissance -- The Frauenthal House (c. 1919) at 2008 Arch Street, designed by Charles L. Thompson and Thomas Harding, Jr., is a somewhat watered-down example of a style that is rarely seen in Little Rock. Though it does not have the decorative brackets under its eaves that are typical of the Italian Renaissance style, it does have a low-pitched, hipped roof covered with tile, as well as widely-overhanging eaves. It also does not have arched doors or windows, but it does have an entryway with small classical columns. Its stuccoed walls also place it in the Italian Renaissance category.

Mission -- The Charles L. Thompson House (c. 1906) at 2015 Broadway, designed by the architect for himself, is an American Foursquare with a shaped Mission-style dormer. A shaped roof parapet on the Gordon House (c. 1910) at 1815 Broadway allows that house to be termed Mission. The Mansion Area's one full-fledged Mission design is the Safferstone House (c. 1920) at 2205 Arch Street, which has the style's characteristic tile roof and stuccoed walls.

*The First Church of
Christian Science
building is a Mission
style structure*



Prairie -- About a half-dozen Mansion Area houses are predominantly Prairie in style. Three are Foursquares with Prairie-style details, including the Whipple House (1909) at 2222 Gaines Street, the only house in the Mansion Area known to have been designed by George R. Mann (architect of the State Capitol and numerous well-known commercial and institutional buildings). With their wide, low profiles, two houses on Arch Street—the Young House (c. 1913) at 2021 Arch and the Shelby England House (c. 1911) at 2121 Arch—come closer than any other Mansion Area houses to being true Prairie-style designs.

Spanish Colonial Revival -- Two small houses in the Mansion Area, both built about 1925 at 1872 and 1874 Gaines Street, have the tiled or flat roofs and stucco-clad walls associated with the Spanish Colonial Revival style. They are, at best, minor examples of the style.

Art Deco (1920-1945 in Little Rock) – Spreading to America from Europe following World War I, this style – featuring a vertical emphasis, smooth walls, and bold geometric ornamentation – is often seen in the commercial and civic architecture of the 1920s and 1930s. Though no buildings in either the Capitol or Mansion Areas can be described as fully Art Deco (or its more streamlined sibling, Art Moderne), several structures in the District exhibit some distinctly Art Deco details including the Harding Apartments (c.1940) at 1520 Broadway, the Safeway Grocery Store building (c.1940) at 1324 South Main, the Human Food Town Store building (c.1940) at 1600 South Main, the Gaines Street Baptist Church Education Annex at 1601 South Gaines (c.1945), and the Ottenheimer Brothers Garment Factory (built 1918, remodeled c.1945) at 110 South Victory.

Minimal Traditional (1935-1950 in the U. S. and Little Rock)

“Minimal Traditional” is the name that has been given to houses built during and after the Depression and World War II that reflect the various revival styles -- especially Colonial and English -- of earlier decades but lack the decorative detailing of earlier houses. Roof pitches also are lower in Minimal Traditional houses.

Fewer than twenty houses in the Mansion Area are Minimal Traditional. Examples are the Kirspel House (c. 1939) at 118 West 20th Street, a toned-down version of the English Revival style, and the row of five Stewart Rental Cottages (1938) at 2114, 2116, 2118, 2120, and 2122 Center Street, all simple versions of the Colonial Revival style. The Mansion Area also has one architect-designed Minimal Traditional, the Cochran Cottage (1937) at 317 West 17th Street, a subdued Colonial Revival design by Max Mayer.

Mid-Century Styles (1935 – 1965 in the U.S.; 1945 – 1975 in Little Rock) Little Rock saw a surge of new construction in the third quarter of the Twentieth Century, fueled by broad societal and economic forces, including the Baby Boom, the Cold War, suburbanization, and the development of the interstate highway system. The State Capitol Area was heavily impacted by these changes, and was transformed after 1950 from a primarily residential neighborhood into the office center seen today. The Governor’s Mansion Area also felt the effects of suburbanization as many of Little Rock’s original neighborhoods fell into a prolonged period of disinvestment. It was precisely these trends that led to the creation of the Capitol Zoning District to manage changes in the areas surrounding the State Capitol and Governor’s Mansion. Nevertheless, some of the architectural styles from this period are now recognized as historic in their own right.

Mid-Century Modern – This style is characterized by rectangular forms with minimal ornamentation, flat or low-sloping roofs, wide eaves or overhangs, and tall windows, sometimes stretching from floor to ceiling. Mansion Area examples include the Central Assembly of God Church building (built in 1953) at 1920 Broadway and the Laing Appliance Store building (c.1968) at 200 West Roosevelt. Capitol Area examples include the Exxon Service Station building (c.1965) at 1706 West Third and the Julian Davidson House (1952) at 410 South Battery.

International – More formal than Mid-Century Modern, International style buildings (often offices) are characterized by a horizontal emphasis; long, smooth walls; large metal windows, often in ribbons; and flat roof lines. The National Old Line Insurance building (1954) at 501 Woodlane is a large-scale example of the style, along with the c.1960 state office buildings at 1507 and 1515 West Seventh Street. The Democratic Party State Headquarters building (c.1952) at 1300 West Capitol and the 1959 Mobilefone building at 414 South Pulaski serve as smaller examples of the style. Several buildings in the Capitol Area blur the distinctions between the Mid-Century Modern and International styles, including the Acme Brick building (c.1964) at 301 South Victory and the Dan Stowers Office building (c.1960) at 1516 West Third. The Pitney-Bowes building (c.1965) at 1722 Broadway is the Mansion Area’s best example of the International style, though the Harvey Hicks Memorial Baptist Church building (c.1950) at 2221 Broadway also exhibits some International characteristics.

Ranch – Easily the most popular style for American homes in the post-WWII period, a typical Ranch style house features a single story or split-level configuration, a simple rectangular or L-shaped footprint, a long, low hip or gable roof, a small front porch, an open carport or attached garage (often on the front façade), and one or more front-facing picture windows, often flanked by smaller windows. Though usually associated with the suburban tract developments of the era, a number of Ranch houses were built in the Mansion Area in the post-war period, including the Gribble House (c.1960) at 1722 South Louisiana and the Wilbert House (c.1960) at 2201 South Chester.

ARTICLE FIVE CAPITOL AREA MASTER PLAN

SECTION 5-101 INTRODUCTION

This Capitol Area Master Plan defines urban design policies for the Capitol Area and establishes a framework for implementing specific design improvements that will establish a distinct identity for this vital Little Rock neighborhood. The plan seeks to foster appropriate design choices that will be compatible with the Arkansas State Capitol and also promotes sound development strategies for reinvestment and enhancement of the Capitol Area. These recommendations accommodate current uses as well as changing land use patterns.



Several blocks of Little Rock's historic housing stock exist within the Capitol Area boundaries.

The plan defines the basic land use policies for the Capitol Area, including building setbacks, development density and parking ratios. Permitted land uses are also established. In addition, the plan recommends an approach to public sector improvements that would establish a sense of identity for the area which also helps to link it with downtown Little Rock. These focus on design concepts that build upon landscape designs established in downtown Little Rock and on the Capitol grounds. Implementing these streetscape proposals will involve cooperation with the City of Little Rock.

The plan also establishes the rationale for design standards that are presented in two other articles in this Rule, *Rehabilitation Standards for Historic Properties* and *Design Standards for the Capitol Area*, which focus on appropriate design approaches for improvements to be made within private property lines.

While the Capitol Area has accommodated a variety of users, and in particular ones associated with state government, it has yet to develop its own distinct niche in the overall urban fabric of the capital city. It needs to do so, both because it would benefit the city itself and also because it would benefit the state at large.

The Capitol Area offers the potential to become a vibrant neighborhood with a diversity of activities that appeal to a broad spectrum of people. Fundamentally, it should provide an attractive foreground for the Capitol building itself and it should support the revitalization of the city core.

At the same time, it should enhance the area as a place for state government, both symbolically and functionally. As the “front door” to the state, the appearance and function of this area plays an important role in Arkansas’ ability to promote itself as a place where the quality of life is excellent and cultural and business opportunities abound. Even a representative of a corporation considering locating in an outlying part of the state will, in part, form their opinion upon their impression of the city in the foreground of the Capitol dome. Therefore, this plan seeks to establish a vision that will help citizens of Arkansas realize the full potential of the dramatic design statement that was made decades ago with the construction of the Capitol building.

SECTION 5-102 The Planning Process

In 1979, shortly after establishing the Capitol Zoning District Commission (CZDC), the State of Arkansas set a master plan in place to preserve the remaining historic character of the neighborhoods around the State Capitol and to maintain the Capitol dome as a dominant feature in the city. The Capitol Area, triangular in shape, was defined as those blocks generally bounded by Cross Street on the east, I-630 on the south, the west end of the Capitol campus and the Missouri Pacific RR on the north.

The initial master plan recommended a mix of uses that would support the functions of state government, including offices, service businesses and housing. It defined a system of regulating building heights that would maintain the Capitol as the prominent structure and also established a hierarchy of sidewalk designs that reflected varying intensities of pedestrian use that were anticipated. A series of corner plazas also were described from which views of the Capitol dome would be prominent.

During the next twenty years, relatively little new development occurred, however. In fact, some businesses moved from the area and a few buildings were demolished. A handful of new buildings did in fact appear and these generally are dedicated to office functions, with little street level activity to encourage pedestrian circulation.

While no radical changes occurred during this time, by 1997, it became apparent that the master plan needed reworking. Revitalization efforts in downtown Little Rock, along the river and at Union Station all suggested opportunities for the Capitol Area to play a more important role in the city's urban framework. Increasing needs to house state government workers have also heightened discussions about policies for locating workers near the Capitol grounds, in the Capitol Area and in the downtown at large. This article reflects that effort.

Community Workshops

In order to develop this Master Plan, the CZDC sponsored a series of workshops in the spring and summer of 1998, which included property owners, local Realtors, architects, elected officials, trade association representatives, city staff and state agencies, to discuss the future character of the Capitol Area. The insights provided by the participants assisted a team of consultants and CZDC staff in focusing on key issues facing the area. This helped to develop appropriate policy and design recommendations and provide a framework for future development. Key discussion points were:

CHARACTER DEFINING FEATURES

Assets:

- The Capitol grounds
- Trade associations
- Small scale office buildings
- Arkansas River

Liabilities:

- Surface parking lots
- Vacant lots
- Buildings that ignore the street

KEY ISSUES

- How to establish height limits on new construction
- Development incentives have not stimulated new building.
- A lack of density/critical mass of building diminishes character.
- A lack of residential uses limits use to working hours.
- A lack of "neighborhood services" discourages residential use.
- A lack of street life discourages mixed use.
- Parking is exposed to the street.
- Fear of losing a parking space at lunch reduces use of the area.
- Big MAC II - The potential to build on the west may diminish potential on the east
- Cooperation between city and state agencies is needed to realize improvements in the area.
- The number of state employees is an unrealized opportunity.
- Short lunch breaks limit state employee use of the area.

The Capitol Area Master Plan includes consideration of these comments generated in the community workshops. In addition, other planning documents, including current city plans and study concepts have been considered.

SECTION 5-103 HISTORIC OVERVIEW

Today's Capitol Area bears little resemblance to the neighborhood it originally was, an area of small frame dwellings surrounding the State Penitentiary and Little Rock's Union Depot. During much of the 19th century, the penitentiary stood on the site now occupied by the State Capitol. About three blocks to the north, Union Depot was a key factor in the neighborhood's development during the latter part of the century.

When the State Penitentiary was completed in 1841, its location was described as "about a mile and a quarter west of Little Rock." Over the course of the next thirty years, Little Rock gradually grew westward so that by the early 1870s a handful of houses stood near the penitentiary. Perhaps because living in the vicinity of a prison was not considered especially desirable, these early residences were simple frame structures.

With construction in 1873 of the Baring Cross Bridge, which was the first railroad bridge across the Arkansas River at Little Rock, the Cairo and Fulton Railroad erected a passenger depot and an office building just north of the State Penitentiary. The Cairo and Fulton Depot stood on the west side of Victory Street between Markham and Garland (formerly Water) Streets, close to the site of the existing Train Station.

The presence of the State Penitentiary may not have encouraged development on the western edge of Little Rock, but the depot—and the jobs it represented—did. Although the scale of development remained modest, during the late 19th and early 20th centuries, scores of houses were built on the streets in the vicinity of the depot—which became known as Union Depot when the Cairo and Fulton merged with two other railroads in 1874 to form the St. Louis, Iron Mountain and Southern Railway and then began sharing the depot with the Memphis and Little Rock Railroad.



The neighborhood around the Union Station included a mix of building types.

Many of the houses that were built became the homes of railroad employees. City directories from the late 1800s and early 1900s list engineers, foremen, conductors and other workers for the St. Louis, Iron Mountain and Southern living near the depot and the penitentiary. Businesses that catered to railroad employees and travelers, especially hotels and boarding houses, also located on streets in the area. It is said that the neighborhood surrounding Union Depot was known as the "Railroad Call District" because the railroad company would send messengers to call employees living in the area to work.

Not only railroad employees lived in the neighborhood around the penitentiary and depot, however. By 1893, the area was served by two streetcar lines that ran west from Main to Victory Street, one on Markham and the other on Capitol Avenue (formerly Fifth Street). Easily accessible, the neighborhood housed a variety of mainly working-class people: craftsmen, laborers, teamsters. In the early years of the 20th century, about 300 dwellings—most of them small frame houses—stood within what now are the boundaries of the Capitol Area.

An important change in the neighborhood became imminent in the late 1890s, when the Arkansas General Assembly voted to construct a new capitol building on the site of the State Penitentiary. The cornerstone of the Arkansas State Capitol—designed originally by George R. Mann and completed by Cass Gilbert—was laid in 1899, but myriad problems beset the building’s construction, delaying its completion until 1915. Despite the fact that a capitol building would seem to be a more prestigious neighbor than a prison, neither the Capitol’s presence nor the penitentiary’s absence seemed to have significantly altered the course of the neighborhood’s development in the short-run. For many years after the Capitol’s completion, the neighborhood remained a modest railroad-oriented area.



An important change in the neighborhood became imminent in the late 1890s, when the Arkansas General Assembly voted to construct a new capitol building on the site of the State Penitentiary.

While the State Capitol was under construction, the old wood-frame Union Depot was replaced by a larger masonry building that was constructed a short distance south and west of its predecessor. Designed by Theodore C. Link of St. Louis, the new “Union Station” was completed in the fall of 1909 after three years of construction. Unfortunately, disaster struck on April 7, 1920, when the station was gutted by fire. Rebuilding took about a year, and the existing station opened during the summer of 1921. By that time, mergers had turned the old St. Louis, Iron Mountain and Southern Railway into the Missouri Pacific, and the station eventually became known as “MoPac Station.”

Through World War II, the station bustled, and the surrounding neighborhood generally remained stable, though houses occasionally gave way to apartment buildings, filling stations or other commercial development. After World War II, the story changed dramatically. The neighborhood was adversely affected by the nationwide decline in railroad transportation, which slowly shut down MoPac Station, and by local factors such as new housing developments that drew residents away from older parts of the city. Deterioration set in, and the neighborhood’s fate was sealed in the 1950s when the City of Little Rock rezoned much of the area for commercial use.

Over the course of the next two decades, the old residential neighborhood that had grown up around the State Penitentiary and Union Depot disappeared almost completely. In its place developed an area of offices, small businesses, state government-related facilities—and parking lots. Soon after the Capitol Zoning District Commission was created in 1975, a report noted that “much of the land [in the Capitol Area] is now empty or is simply used for parking.”

Since the Commission began its work, new development in the Capitol Area has come closer than before to respecting the scale and dignity of the State Capitol. However, the demands of an ever-growing state government, coupled with those of the many entities that need to be near the seat of government, present an ongoing challenge for the Capitol Zoning District Commission as it works to preserve the prominence of the State Capitol and ensure that the surrounding environment is compatible with the Capitol’s significance.

The area around the Arkansas State Capitol is in a period of transition. It originally developed as a residential neighborhood where single family structures were typical in most blocks. These residential buildings faced the street, where front porches established a human scale and added interest for passersby. Front lawns were defined by fences and shrubbery that also made walking a comfortable experience.

Although this residential character was the primary feature of the neighborhood, certain “subareas” also existed with different characteristics. For example, in the blocks around the train depot, a mix of uses emerged, including boarding houses and hotels. Historic photographs indicate that this area was lively with people coming and going throughout the day.

The area around the State Penitentiary also had its own distinct character. The penitentiary was constructed on a hilltop at what was then the western edge of the core city. Larger housing blocks mixed with other institutional buildings on the penitentiary grounds and a scattering of single family structures added to the scene.

The area’s most distinctive focal point was created, however, with the construction of the State Capitol at the old penitentiary site. Designed in a neoclassical style and capped with a towering dome, the building itself is a dramatic monumental structure and is set in a parklike environment, providing a unique identity to the neighborhood. It was sited on an axis that reflected a shift in the orientation of the streets at this location in the city.

Over the years, additional state office buildings were added to the west of the Capitol itself, creating a campus of an institutional character. Initially, these were organized around a circular drive with landscaping in the center. In time, substantial portions of the area to the west were paved for parking lots.

As train travel declined, so did the area around the depot. Several original buildings were demolished while others deteriorated. The depot stood virtually isolated from the city core and the capitol itself, although it remained a prominent visual landmark.

In the mid-twentieth century, the neighborhood east of the Capitol also changed substantially. Houses were demolished in many blocks to make room for a variety of commercial buildings. Others were simply allowed to decay to the point that restoration was not feasible. A few apartment buildings also were constructed, in part to house legislators. Some of these structures were quite substantial in size. The result, as seen today, is an eclectic mix of older single family houses, small commercial buildings and larger offices.

In recent years, the trend to build office buildings has continued, although at a relatively slow pace, whereas no new housing has appeared for some time. In a few locations, however, reminders of the earlier residential neighborhood survive. Sometimes, a row of houses remains intact, providing a sense of the earlier character. In other cases, individual houses stand isolated in parking lots or they are framed by newer commercial buildings.

The most striking feature from this transitional period of development is the creation of many large surface parking lots. This has led to a series of freestanding, independent buildings in an open sea of asphalt, intimidating to the pedestrian, having no strong sense of visual continuity with the street or with other buildings in the neighborhood.

Overall, a relatively low density of building exists, in relation to the significant amount of development potentially available, based on existing zoning. This low density impedes the ability of the area to be perceived as a distinct place.

SECTION 5-201 CAPITOL AREA GOALS AND RECOMMENDATIONS

The Capitol Area lies in a strategic location. It forms the western boundary of downtown Little Rock while also creating the foreground for the Capitol building itself. Symbolically, this area should be the “front door” to the state, with Capitol Avenue serving as a key ceremonial corridor. It should be the area that residents from all over Arkansas feel is the place to bring family, friends and visitors because it represents their common interests and highlights the importance of the Capitol.

However, Capitol Avenue has not developed to its potential. Construction has proceeded slowly and at a relatively low density. As a result, the street scene is fragmented and is unwelcoming to pedestrians. A more continuous line of occupied buildings and active open spaces is needed to animate the area.

In terms of the uses, a lack of focus also exists. Land uses should reinforce the emerging trend as a place for organizations that seek to conduct business with state government.

Uses also should reinforce development objectives for the core of Little Rock. As the immediate downtown area revitalizes as a commercial center, the lands around its periphery, including those of the Capitol Area, are becoming increasingly important as locations for uses that will help to energize the core. In that regard, service businesses, dining and entertainment, and especially housing and accommodations, are uses that should be encouraged.

Housing opportunities should particularly be considered. Mixed use projects that incorporate commercial uses with residences could be successful here and would greatly extend the hours of activity that will help to animate the street.

In general, a moderate density of development should be promoted throughout the Capitol Area, a density that will be compatible with historic resources and also reinforces a pedestrian-oriented scale. Buildings averaging three stories in height are therefore envisioned, with some variety in scale in different sectors of the neighborhood.

The protection of important views also remains an important land use consideration. Established policies have consistently stated that development in this area should defer to the Capitol building, in particular in the way in which they protect views to Capitol dome.

To some extent, this means that development should remain at a moderate scale. A key factor in the development of the Capitol Area will be how the State decides to meet its needs for office space in the future. The best way to encourage private investment here will be to demonstrate a public commitment by locating state offices in the Capitol Area. This may occur in a variety of ways, but what is important is that the gesture be made.

A particularly important site lies at the northeast corner of Woodlane and Capitol Avenue. Positioned at the foot of the Capitol building, its potential development is a keystone in setting the character for future building. If this site is developed with an adequate critical mass and designed in a compatible manner, it could establish a direction for the Capitol Area.

A variety of elements can add accent to the setting and help to length various uses into an overall urban framework. These include improvements to the streetscape, construction of special plazas and gateways and enhancements to circulation systems. Many of these activities extend beyond the Capitol Zoning District Commissions immediate jurisdiction and require cooperation among other state agencies as well as the City of Little Rock. It is important that the Commission work proactively to facilitate such improvements.

With this vision in mind for the Capitol Area, a series of goals for land use and for urban design are established to guide development. These are presented below.

A. Goals for the Capitol Area

1. To activate the area with a mix of uses

The Capitol Area should accommodate a variety of users: This should include legislators, trade associations and service businesses. In addition, tourists and local residents should be recognized as important user groups. Promoting a mix of uses will support a lively neighborhood in use twenty-four hours a day. While the predominant use will continue to be offices, other commercial uses including dining and retail are encouraged. In addition, an important goal is to promote new residential uses that will combine with the other activities to animate the neighborhood.

2. To promote the development of more institutional and professional office uses

Locating state offices within the area should be a high priority. In addition, facilitating the development of offices for organizations that conduct business with legislators should be encouraged, as well as expanding business opportunities for professionals that provide support services to these uses.

3. To promote the development of housing that is compatible with the scale of the neighborhood

Construction of moderate density housing should be encouraged. This includes patio homes, townhomes and low-rise apartments. Densities should vary to be compatible with the context of the specific character area. Combining housing with other uses should be a priority.

4. To provide reliable public transportation to serve the area

Transit service should be enhanced to facilitate circulation within the area and to link it to adjacent parts of the city. Locating development along major transit corridors should be encouraged in order to promote the use of public transit.



The Capitol Zoning District Commission wishes to promote the development of housing that is compatible with the existing scale and character of the neighborhood.

5. To establish a distinct identity for the neighborhood

The Capitol Area should be perceived as a special place that has a distinct physical character. This should include a sense that the area is a lively, attractive place to live, recreate and conduct business. Promoting the use of a consistent streetscape palette will help achieve this goal.

6. To provide an attractive foreground for the Capitol

Development should convey a positive image as the setting of the capitol building. Building and site designs should establish a sense of continuity while also accommodating variety in stylistic treatments. Design guidelines should promote this concept.

7. To define and enhance views to the Capitol

This means that key view corridors to the Capitol building should be identified and preserved. Where feasible, the sequential experience of moving through space and perceiving views as they unfold should be planned. For example, in some cases, views should be framed with the thoughtful placement and massing of buildings. In other cases, views should remain open and broad. Installing utility lines underground should be a priority to enhance views as well.

8. To enhance the character of individual neighborhoods within the Capitol Area

The tradition of having neighborhoods with distinct identities should be continued. For example, where historic residential buildings survive in sets, that character should be preserved. Similarly, the distinct character of the neighborhood around the depot should continue to be reinforced. The State Capitol and its campus is the most significant public space in the state, serving as the symbol of the state government to all residents of Arkansas. For this reason, Capitol Avenue should develop with a ceremonial approach to the Capitol as its defining feature.

9. To enhance the pedestrian experience throughout

Streets should once again be places that are active with pedestrians, where walking is a pleasant experience. The automobile should appear subordinate to other uses and therefore parking and circulation requirements should be accommodated in a manner that supports the desired uses for the neighborhood. Increasing landscape treatment along sidewalks, creating plazas and installing public art are actions that should be promoted.

10. To establish a sense of visual continuity within individual neighborhoods

Landscaping should help establish a sense of visual continuity. It should include places for outdoor activities, including plazas and courtyards, as well as visual accents that give identity to individual blocks. This should incorporate public art and other unique urban design features. Key intersections and gateways are opportunities to install landscape designs that will contribute to this sense of continuity. These intersections are also appropriate locations for the installation of commemorative monuments.

B. Land Use

Within the immediate Capitol campus and interface areas, it is likely that development will continue to respond to state government services needs. The provision of facilities and capital improvements within the Capitol Area will continue under the direction of the Capitol Zoning District Commission (CZDC), including the adopted recommendations within this plan.

The emerging land use and development pattern of areas immediately adjacent to the Capitol, however, will continue to respond to broader market trends and not necessarily guarantee such a predictable outcome of events. Portions of the area reflect an earlier period of development, some predating the building of the Capitol itself. Much of the area includes smaller lots and parcels for residential development. A transitional character with larger commercial buildings mixed with small residential buildings has resulted in much of this area. Along Capitol Avenue, the intended commercial land use pattern has never fully emerged as the density remains low. Large surface parking areas imply that market demand in this area has not been realized as of yet.

The area should develop as a “mixed use village,” in which a combination of professional offices, public and private institutions, service business and dining join with residential uses to form an active neighborhood. A framework of trails, walkways, plazas and open spaces should help to link the neighborhood and to provide accent to its character.

This development should occur in a manner that reinforces the vision for the different character areas defining in the zoning districts. For example, in Zoning District B, the historic residential character is to be respected, even as new development is encouraged. By doing so, the neighborhood at large will develop with a series of subareas that each hold distinct identity while also working together in a broader urban design framework as an important part of the city. It is particularly important to note that this development will also enrich the Capitol Complex itself. It will provide a context that is inviting for employees and elected officials and that enhances the quality of the business day for them.

Recommendations:

1. Promote development to reinforce the proposed character areas.
2. Enforce Design Standards that will maintain and enhance the character of the area.
3. Continue cooperative efforts between the State, City, private owners and developers to encourage a comprehensive mixture of land uses in an effective an efficient manner.
4. Encourage the location of state offices in the area.

A variety of mixed use scenarios should be encouraged in the Capitol Area. The figures below illustrate compatible development that includes residential apartments and townhouses, combined with commercial functions. In general, commercial uses are located on ground levels and at corners. Parking is located to the interior.

In Figure 1, infill development combines with existing historic houses to create a relatively low density of development that is compatible with its context. To the right, a higher density is achieved. On sloping lots, uses can be stacked or terraced, providing multiple points of access.

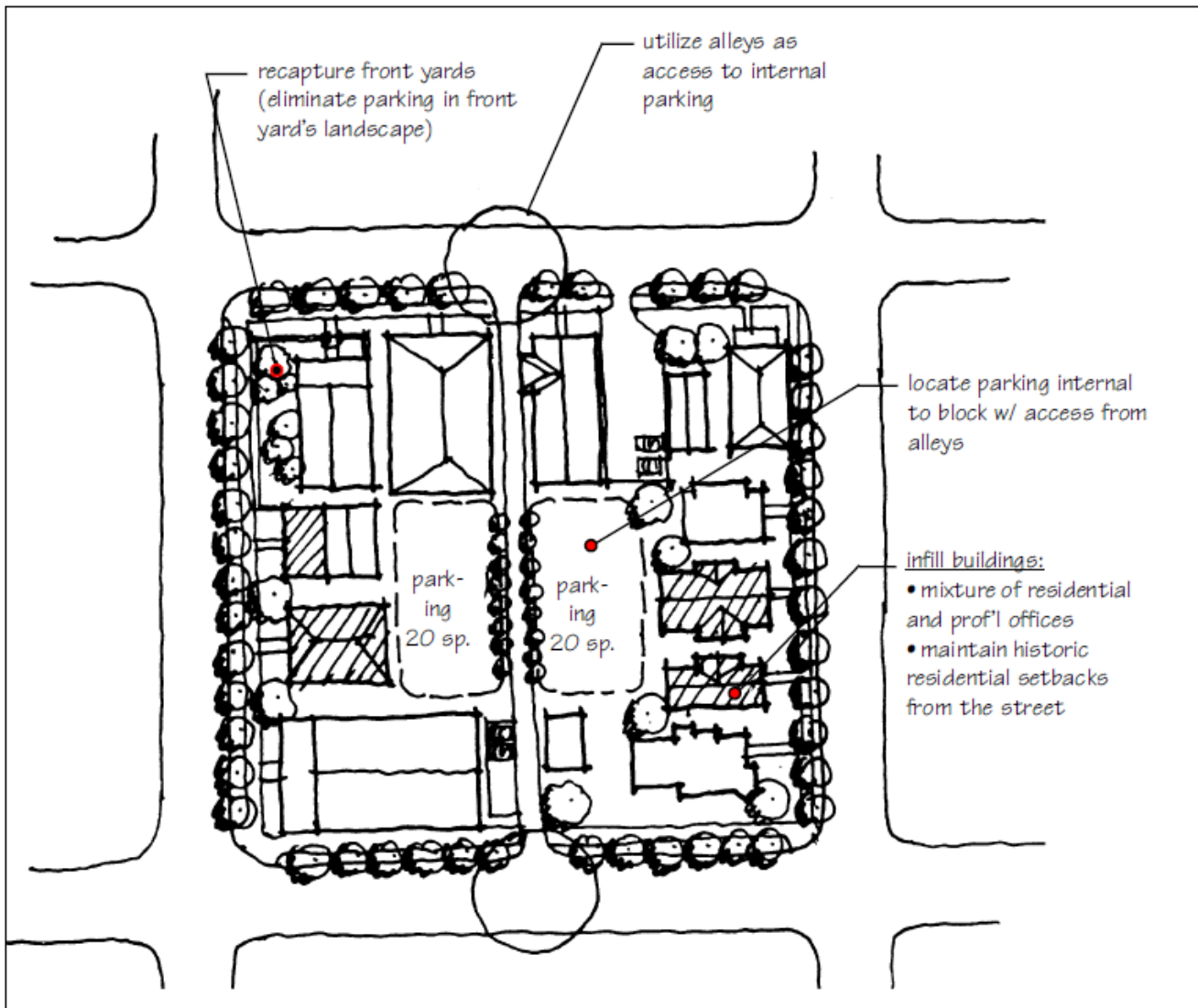

Figure 1. Low density, mixed use development scenario plan, which includes the adaptive use of historic structures, a mixture of residential and office uses, parking internal to the block and similar historic residential setbacks.

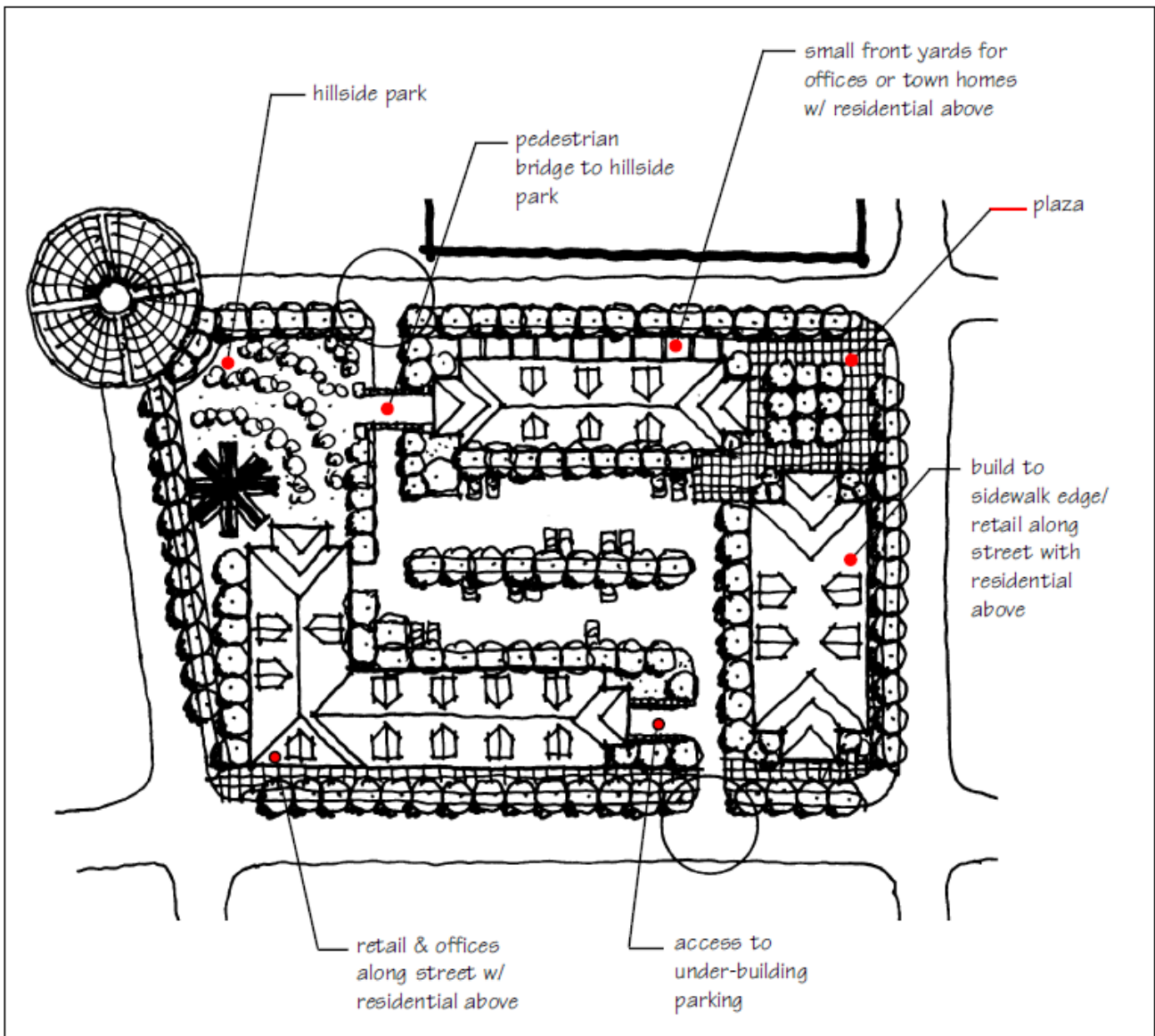

Figure 2. Mixed use redevelopment (with residential, commercial and office uses) plan.

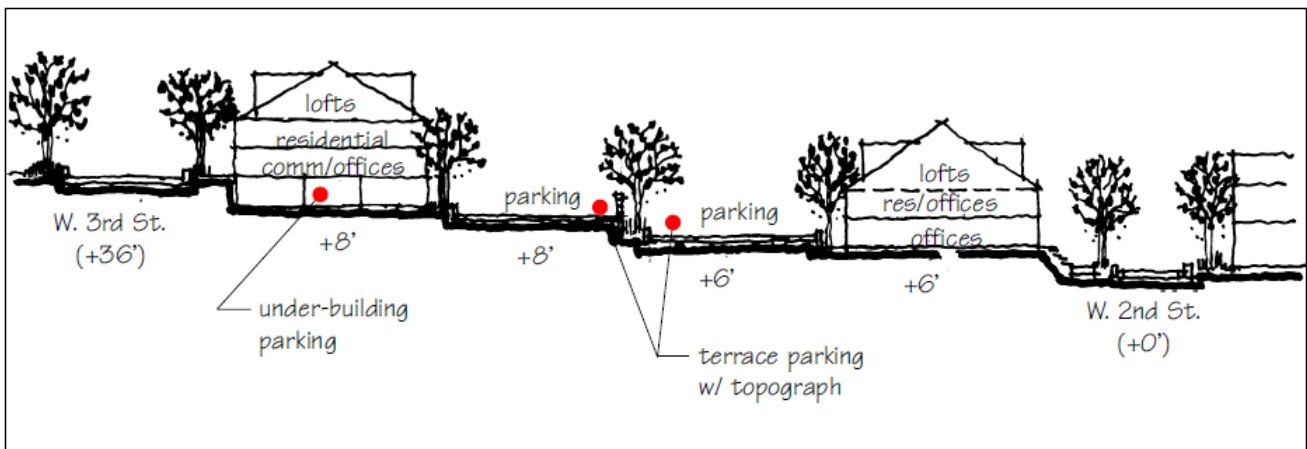

Figure 3. Mixed use redevelopment (with residential, commercial and office uses) section.

C. Topography

The map in Section 5-401 (B) illustrates the topography of the area. The hilly terrain that dominates the Capitol Area contributes to its distinct character and also offers opportunities for creative development. The most prominent prospect is, of course, the Capitol itself. The height of its topography contributes to the monumental scale of the building and provides views from the Capitol to a variety of landmarks, including the river, downtown and Union Station.

Aside from Capitol Hill itself, the land is highest in the southeastern corner, along the edge of I-630 highway eastward into the downtown. This provides easy views from the heart of the commercial district to the Capitol, as well as from the freeway. The land then rolls gently through the central portion of the area, along Capitol Avenue and 4th Street. It falls to the north into the bottom lands along the railroad. Buildings that are located in these lower areas tend to appear relatively low in scale, with respect to the Capitol, and they are less likely to impede views of the Capitol dome.

Because the topography influences view opportunities where the land is relatively flat, views across the area to the Capitol may be affected. In contrast, where the land drops substantially below the base of the Capitol, it is possible to construct buildings that are taller than three stories and still maintain views. For this reason, it is important to take topography into consideration when designing a building in the area.

Recommendation: Appropriate building heights should be determined, in part, by the topography of the site. The design standards should reflect this consideration.

D. Figure Ground Patterns and Views

The footprints of buildings that existed in the area, as of July 1998, are shown on the map in Section 5-401(C). Each of the buildings is shaded, while surface features, such as parking lots and street curbs, are shown in outline. The map demonstrates the relatively low density of development, in terms of the amount of land area that is occupied with buildings. Many buildings stand isolated, surrounded with streets and parking. This, to some extent, translates into the character of the street experience for pedestrians, in which large expanses of unattractive pavement discourage walking and thereby limit business opportunities.

The figure-ground analysis also suggests the locations of those areas that retain some of their historic residential character. For example, a block of buildings along Pulaski Street, between 3rd and 4th Streets reflects the scale of early houses that were once more extensive in their reach.

This map documents key view corridors as well, both to and from the Capitol. Key views to the Capitol lie along Capitol Avenue, from the downtown and from Cantrell Road. Views of the Capitol from Interstate I-630 are also noteworthy.

Three types of view experiences should be considered:

1. Open View Planes

In many cases, views are broad, extending in an arc of many degrees. These usually occur at higher elevations and may be experienced by pedestrians and motorists as they move through space. The views to the Capitol from Cantrell Road are examples. Where view planes are to be maintained, building heights generally should remain low.

2. View Corridors

In other situations, a distinct view may be framed by other objects, especially buildings. Rather than being broad in scope, the view is focused. These vistas can be experienced moving in space as one proceeds forward along a corridor. Framing a view with buildings can help convey a sense of scale and the result can be dramatic. The view corridor along Capitol Avenue to the Capitol is an excellent example.

3. Vista Point

Finally, some view experiences occur from a fixed station point, such as a plaza. These may provide views to an individual object, or to a panorama. The view from the main entry to the Capitol building is an example of this type.

Recommendations:

1. View experiences should be planned as a part of each development in the Capitol Area.
2. A mix of view experiences should be provided throughout the Capitol Area.

E. Building Height and View Considerations

A special goal within the Capitol Area is to maintain and enhance views to the Capitol dome. In general, building scale should remain relatively low in order to assure that these are maintained. However, occasions do exist where taller buildings could be constructed and views still be maintained. These should be considered on a case by case basis through a special height review process.

Criteria for additional height are included in the Capitol Area Design Standards. In general, consideration should be given to the type of view that is to be established or maintained. In addition, the character of the height of the building as it would be perceived on downhill sides, where dimensions would appear to be taller, should be considered.

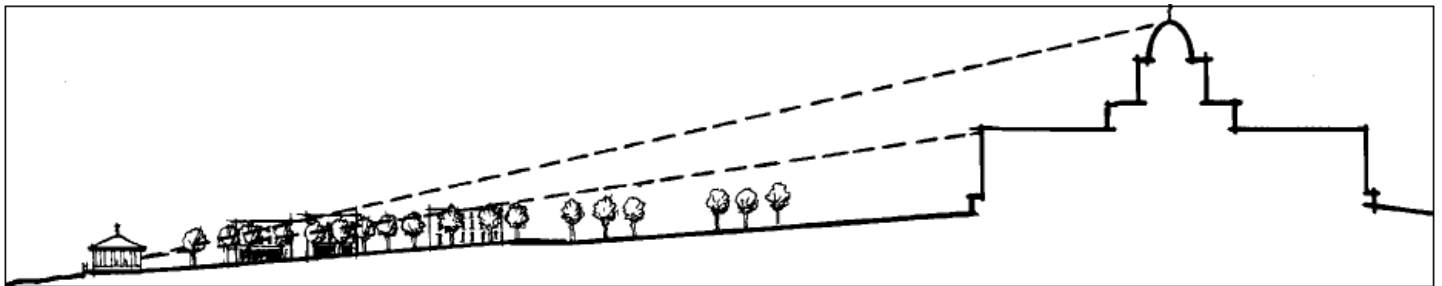

Figure 4. A special goal within the Capitol Area is to maintain and enhance views to the Capitol dome.

F. Historic Resources

The Capitol building stands as the most noteworthy historic landmark in the area. Union Station is also an important edifice as is the old station hotel. Preservation of these landmarks should remain a high priority. Furthermore, development around these resources should occur in a manner that is compatible with them.

In addition, a scattering of vintage residential structures survives. In some cases, these stand in groups where they establish a modest historical context, whereas in others these resources stand as individual properties that suggest the early character of the area.

These historic resources enrich the area and contribute to its distinct character. Preservation of these properties is, therefore, a priority. Demolition of these structures should be avoided whenever feasible and their reuse should be encouraged. New development near these resources should also occur in a manner that will be compatible with them.

Recommendations:

1. Design standards should encourage new development that will respect historic resources that are nearby.
2. Developments that include preservation of historic buildings should be encouraged.
3. Views to historic resources should be maintained.
4. A survey of historic resources should be maintained as an information base. This data should be considered when determining the historic significance of a property.



An early photograph from the Capitol, looking east toward downtown Little Rock illustrated the residential character that this street once had. The few surviving houses from this period are important historic resources that form a link to this part of the city's past.

SECTION 5-202 CAPITOL AREA ZONING DISTRICTS

A series of neighborhoods exist in the Capitol Area, which should serve as a foundation for establishing identity and a sense of place. Therefore, assets and opportunities of each of these neighborhoods should be considered in monitoring development. These areas are slightly varied. Some have distinct features which are well established, while others are in transition, still developing their identities.

An important issue is how to protect or enhance those existing "character areas" which could promote a broader mix of uses before they in turn are lost and how to shape new emerging areas to support the goals of the master plan. The Capitol Area has six distinctive character areas. (See the Capitol Area Zoning Map in the General Standards.)

A. Zone "A"- State Capitol Foreground

Capitol Avenue should be the State's principal ceremonial street, dominated by the terminus at the State Capitol. This spine links the State Capitol with downtown Little Rock. This area has been seen as an infill area for governmental offices, commercial uses, professional offices and support businesses for the area, with a character of buildings that front onto streets similar to a boulevard. To date, the area has not realized its potential. Many buildings remain isolated and fail to contribute to a sense of being a major public corridor. To some extent, it appears as a low density office park without a distinct image.

Recommendations:

- 1.** This area should develop as a professional office center with supporting commercial uses that create a spine linking the Capitol Area to Downtown. A mix of governmental and private professional offices should be the prominent use with service businesses, dining and retail uses supplementing.
- 2.** Defining views to and from the Capitol should be a primary consideration in development patterns. Buildings should be strategically located at the edge of the street to frame views and to provide an attractive pedestrian zone.
- 3.** Medium scale office buildings with ground floor storefront activities should define the street edge and all parking be located to the rear.
- 4.** Views should open up at street intersections and a major public plaza should be established at the terminus with Woodlane.
- 5.** Sidewalks should be at a scale that promotes pedestrian use. They should be enhanced with trees and a coordinated set of street furniture. The design palette established by the City of Little Rock for Capitol Avenue should be used.
- 6.** The commercial areas to the north and south of Capitol Avenue should also continue to develop as a concentration of governmental offices and commercial uses, including professional offices and support businesses, but at a density that is slightly lower than that along Capitol Avenue itself.

7. Defining views from major roadways, including Interstate 630, to the Capitol dome should be special considerations here and pedestrian connections to Capitol Avenue and to the State Capitol should be enhanced. Landscaping of parking lots will be particularly important for this reason.

B. Zone "B"- Capitol Area Residential

The areas protected by this zone retain the greatest number of historic residential buildings which still reflect the early development pattern of the Capitol Area. Gable roofs, small rectangular building forms, front lawns and site retaining walls are among the special features that contribute to the scale of these small neighborhoods.

Recommendations:

1. A mix of residential and low intensity non-residential uses should be encouraged that would be compatible with the traditional character.
2. The remaining historical residential buildings should be retained and new construction in this area should be designed to be compatible with this established context.
3. Variety in building setbacks is appropriate in this area, but should reflect the traditional front yard dimensions and be landscaped.
4. Parking should be located to the side of a building or in the rear and screened from view.



These remaining historic houses contribute to the character of the Capitol Area.

C. Zone "C"- Union Station Mixed Use Neighborhood

This area, sometimes designated as “Northgate,” includes buildings and lands around the historic Union Station.

Recommendations:

1. The Union Station neighborhood should develop with a mix of uses that supports the adaptive reuse of the station itself. Given its proximity to the Capitol, Downtown and other convenient traffic routes and trails corridors, a mix of residential, office, dining and retail should be encouraged. The area should “anchor” specialty and retail uses emerging along Markham Street.
2. A variety of building types and setbacks is appropriate with medium density residential uses on the 2nd and 3rd floors above.
3. A focus should be placed upon creating a “pedestrian friendly” environment that invites “exploration” of the neighborhood and makes for connections to trail systems, such as the Arkansas River Trail.



The Union Station neighborhood should develop with a mix of uses that supports the adaptive reuse of the station itself.

D. Zone "D"- Interstate Industrial

This small zone is located at the southwest corner of the Capitol Area and contains a collection of warehouses and maintenance shops. It lies below the Interstate at the lower end of the Capitol campus. Motorists approaching downtown from the west look across these lands to the Capitol dome. It is zoned for industrial uses, in part because it is relatively remote and access is limited. While it is not a key area in terms of planning for the character of the foreground of the Capitol, it is important that its development within this area be managed such that it does not impede views to the Capitol.

Recommendation: Maintain the low scale of development in the area. Protect views of the Capitol by keeping building heights relatively low.

E. The Capitol Campus Complex

This area includes the State Capitol and the campus of open spaces and government buildings immediately adjacent to it. As well as being the focal point of the Capitol Area, it defines the Area's western edge. Within this campus, large institutional buildings are sited on individual, freestanding parcels. Parking is located in a network of surface lots that serve several buildings nearby. Architecturally, building styles are eclectic, although a general palette of grey stone and concrete provide a certain sense of visual continuity. Comprised entirely of state-owned property, the Capitol complex is exempt from the Capitol Zoning District Commission's jurisdiction. (Land owning state agencies are subject to a separate design review process administered by the Division of Building Authority.)

Recommendations:

1. A special master plan was developed in 1974 by the Arkansas Public Building Authority for the Capitol grounds. It recommends improving landscape features that would enhance pedestrian connections to the east. The Capitol Zoning District Commission has adopted this plan by reference.
2. Development abutting the Capitol grounds should incorporate landscape design elements from this plan when feasible.
3. In addition, high priority should be given to locating new state offices in the Capitol Area.
4. The Commission and its staff will endeavor to coordinate with the Secretary of State's office, the Division of Building Authority, the Capitol Parking Control Committee, the Capitol Arts and Grounds Commission, and other agencies to promote uniform and appropriate physical development on the State Capitol complex.

SECTION 5-301 STREETSCAPE DESIGN

A key component of the Master Plan is the development of a comprehensive design image for the Capitol Area that will help establish a sense of identity. Streetscape design includes the introduction of street trees, furniture such as benches and waste receptacles and construction of planting areas, all coordinated to establish a distinct identity for the area. The city's streetscape palette used on eastern portions of Capitol Avenue are positive precedents that should be continued.

Elements to be considered include: A consistent public landscape palette, distinctive gateway designs, consistent architectural design and special public improvements. The Capitol Area's streetscape design should serve to reflect the differing characteristics of each neighborhood in the area, while also establishing a sense of visual continuity throughout.

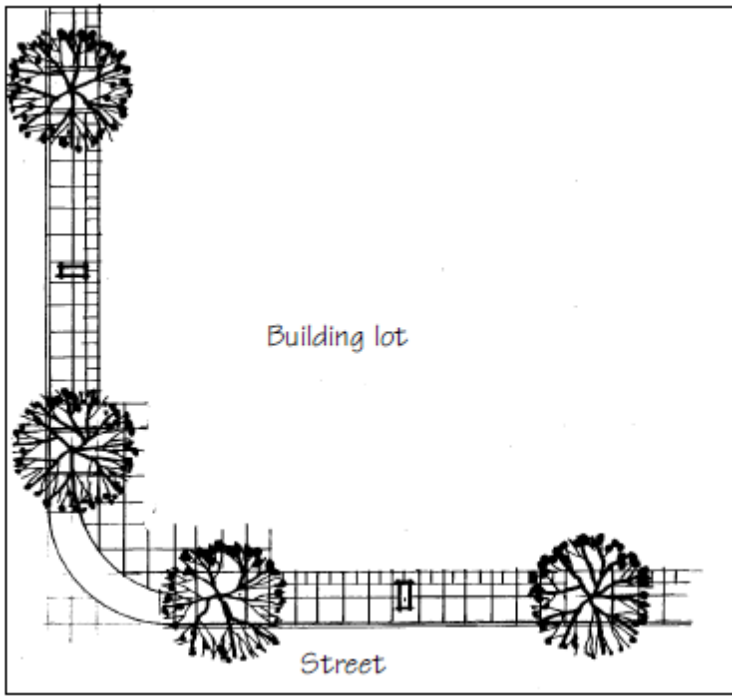

Figure 5. A prototype for streetscape improvements.

Decorative street furniture elements, including ornamental lights and street trees, should be installed to match designs adopted by the City of Little Rock for east Capitol Avenue. In addition, decorative scoring patterns for concrete sidewalks should be considered for the blocks that are closest to the Capitol.



Defining the street edge and enhancing the pedestrian environment are goals for the area.

A. Streetscape Hierarchy

The character of the design of streets in the Capitol Area should be considered as a system. In time, streets should develop to reflect the character described:

1. High Density Commercial Corridor (Capitol Avenue and Victory Street)

Streets designated in this category are those in which commercial buildings are to be the dominant use. Building fronts should generally be located at the inside edge of the sidewalk and urban streetscape elements such as street trees, decorative street lights, benches and planters incorporated. Victory Street should become the primary north-south pedestrian connection through the area and therefore it is appropriate that pedestrian gathering spaces be developed along with these urban streetscape elements.

2. Medium Density Mixed Use Corridor

These streets will be lined with a mix of commercial and residential uses at a moderately high density. Defining the street edge with buildings is also a goal in these areas, although some variety in setbacks may occur where residential uses are at street level. The majority of buildings within a block should be built with their fronts at the inside sidewalk edge. Incorporate urban streetscape elements. The majority of east-west streets in the Capitol Area fall into this category.

3. Low Density Mixed Use Corridor

This street category applies to those streets that are residential in character. Development and redevelopment along these streets should reflect such a residential character and be set back from the street according to the historic pattern, with landscaped front yards.

4. Capitol Complex Edge

Those streets immediately adjacent to the Capitol campus are critical to the overall image of the Capitol. The landscape palette of the capitol grounds should be extended across the street to the east to strengthen this image. Buildings along this edge should generally be set back from the street to provide a “green” transition to the more intensely developed areas adjacent to the Capitol campus.

B. Gateways & Plazas

Another key component of the Framework Master Plan is the creation of and enhancement of gateways into the Capitol Area that notify motorists, bicyclists and pedestrians that they are entering a special district. Because there are a limited number of entries into the area from both the west and south, these gateways become even more important. Gateways into the Capitol Area are located at Woodlane Street and west 7th Street, the 3rd Street bridge across the Missouri Pacific Railroad and Cross Street at Capitol, West 3rd Street and West Markham.

Recommendations:

1. Gateways into the Capital Area should be designed with motorists, bicyclists and pedestrians in mind. A consistent landscape palette should be applied to each of these locations to establish a sense of continuity. At the same time, a unique element should appear at each major gateway to distinguish it from the others. Installing custom-designed artworks at each location is one means of accomplishing this objective.
2. Some elements should be large enough in scale to be perceived at a distance by drivers, such as flowering ornamental trees or public art.
3. Information signs should be provided that can be read by and are easily identifiable to a motorist or bicyclist that is slowed or stopped at an intersection.

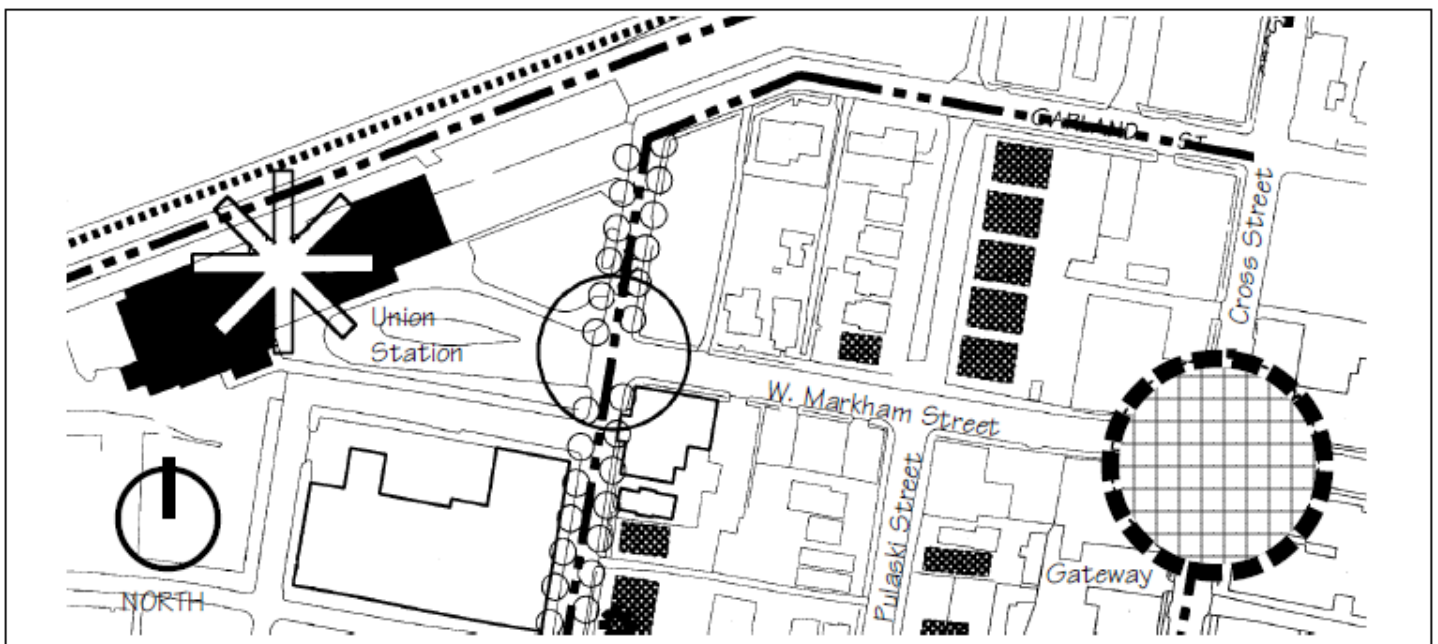

Figure 6. West Markham Gateway.

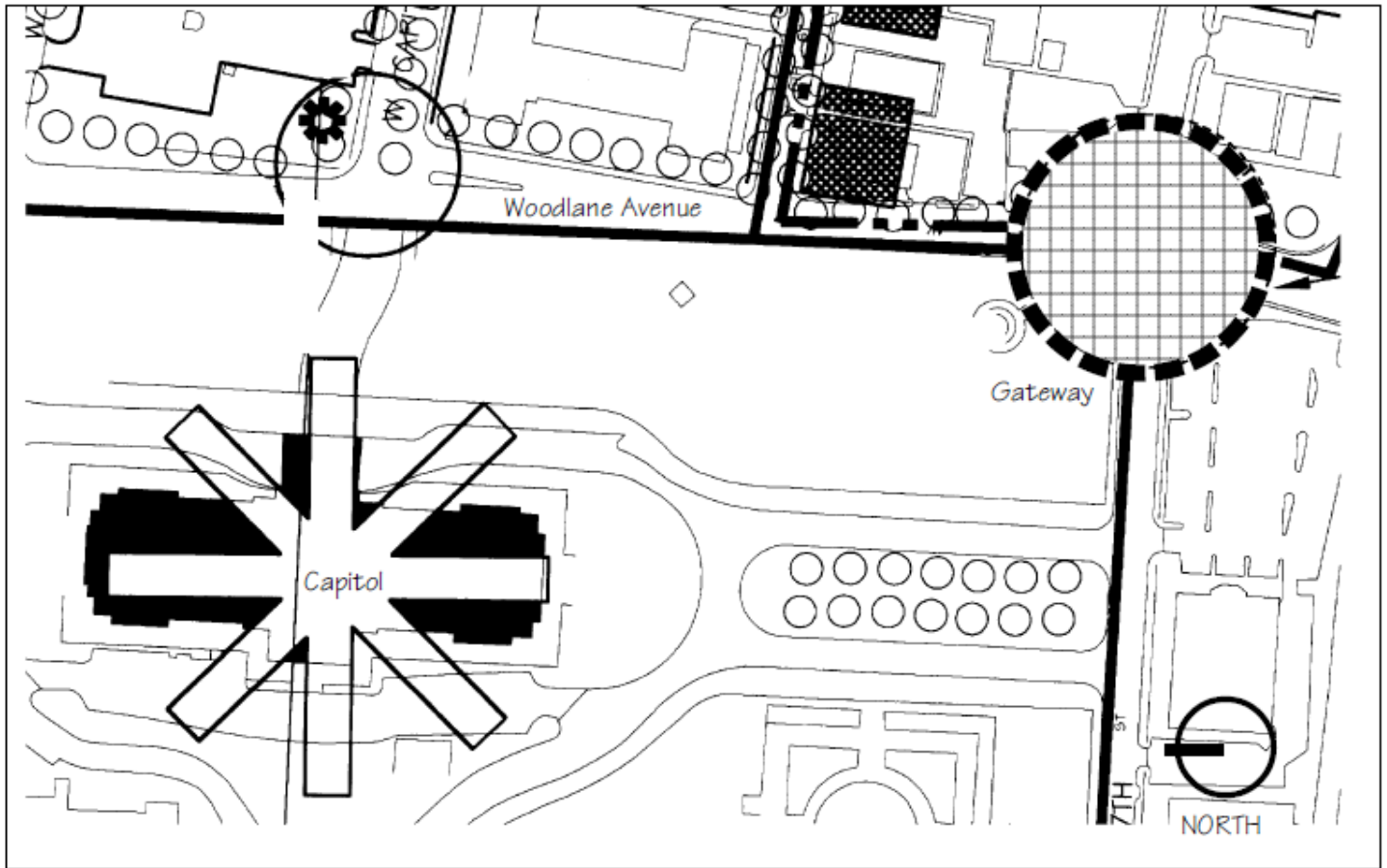

Figure7. Woodlane Avenue Gateway.

Fine-grain detail should be introduced for viewing by pedestrians and by motorists in stopped cars. Examples include; low shrubs, ground covers and perennial and annual flower beds.

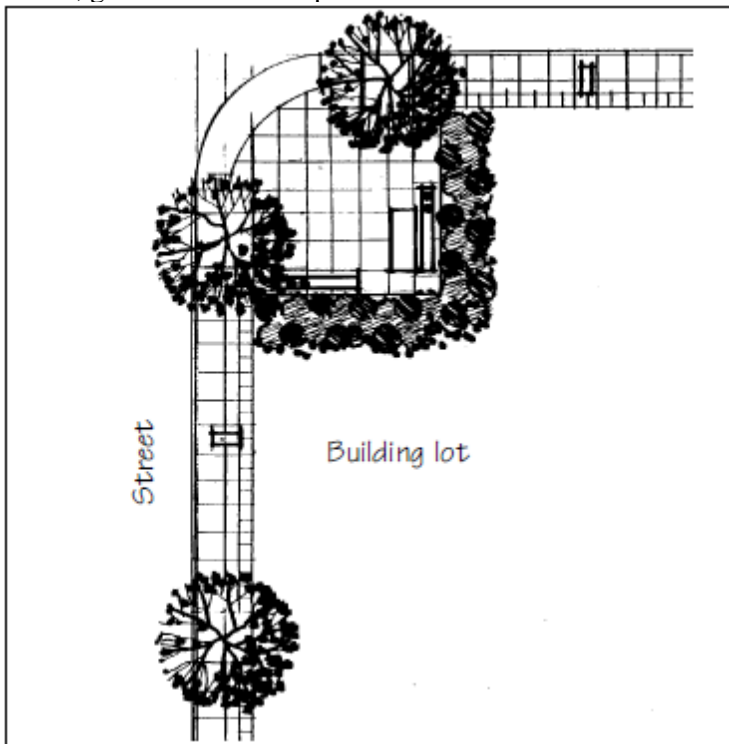

Figure 8. Prototype for a corner plaza

Small plazas should be created on corners of lots that lie at key intersections and gateways as identified on the Capitol Area Framework Plan (See the map in Section 5-401.A). At key intersections, these plazas should incorporate a combination of the street furniture elements. The inside edges of the plazas should be defined with building walls or with landscaping.

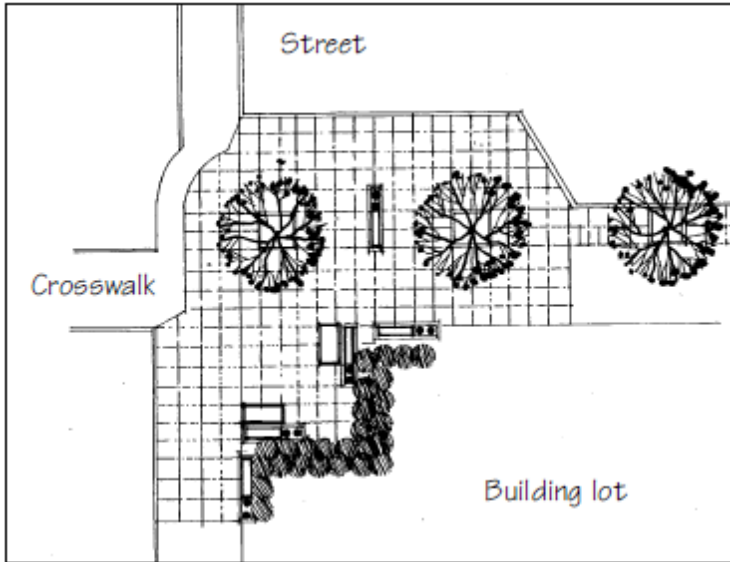

Figure 9. *Prototype for a corner plaza*

At major gateways and key intersections along Victory, larger plazas should be established at corner lots. Decorative paving should extend across the area and, where feasible, the sidewalk should be expanded to reduce pedestrian crossing distances. Street furniture should be clustered in groupings to increase visual impact. These plazas provide special opportunities for information boards, memorials and public art. The inside edges of these plazas should be defined with building walls or landscaping.

C. The Gateway Concept at Third Street Viaduct

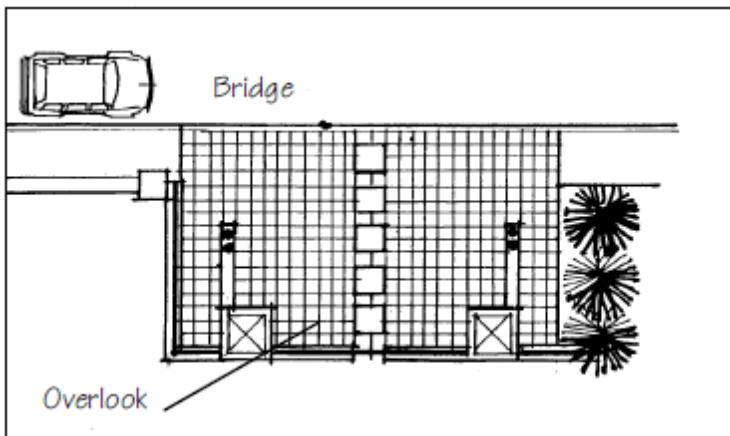

Figure 10. *Overhead view of possible gateway near Third Street viaduct*

A special gateway opportunity exists at the Third Street “Bridge”. Because the road is elevated at this point, motorists and pedestrians have a particularly dramatic view of the Capitol building. In this concept, an overlook area is created by extending the walkway. Street furniture elements, including benches, lights and planters, would be included.

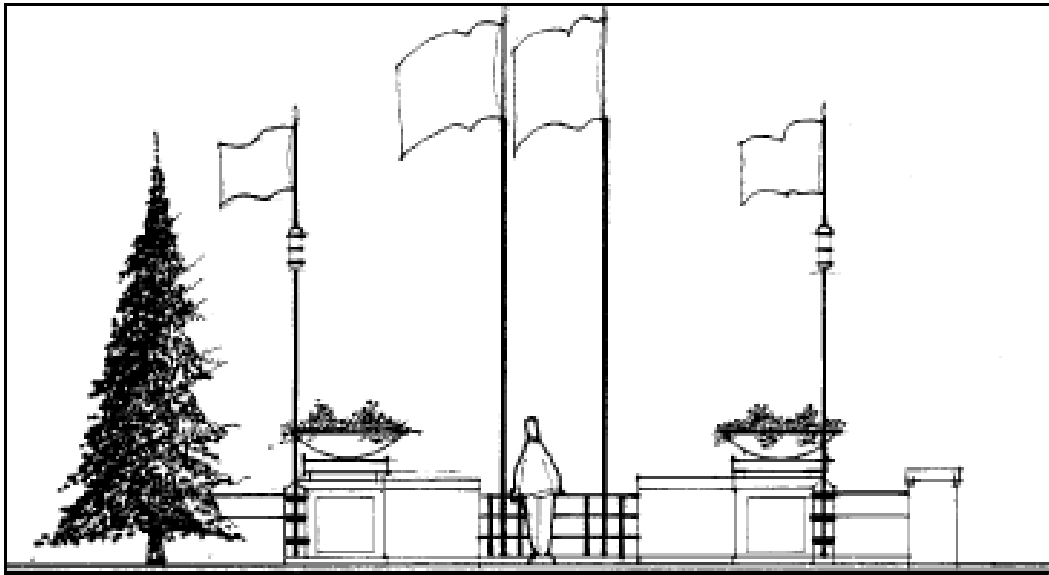

Figure 11. Gateway elements combined in this conceptual sketch at the Third Street Bridge include monumental planters, lighting and flagpoles.

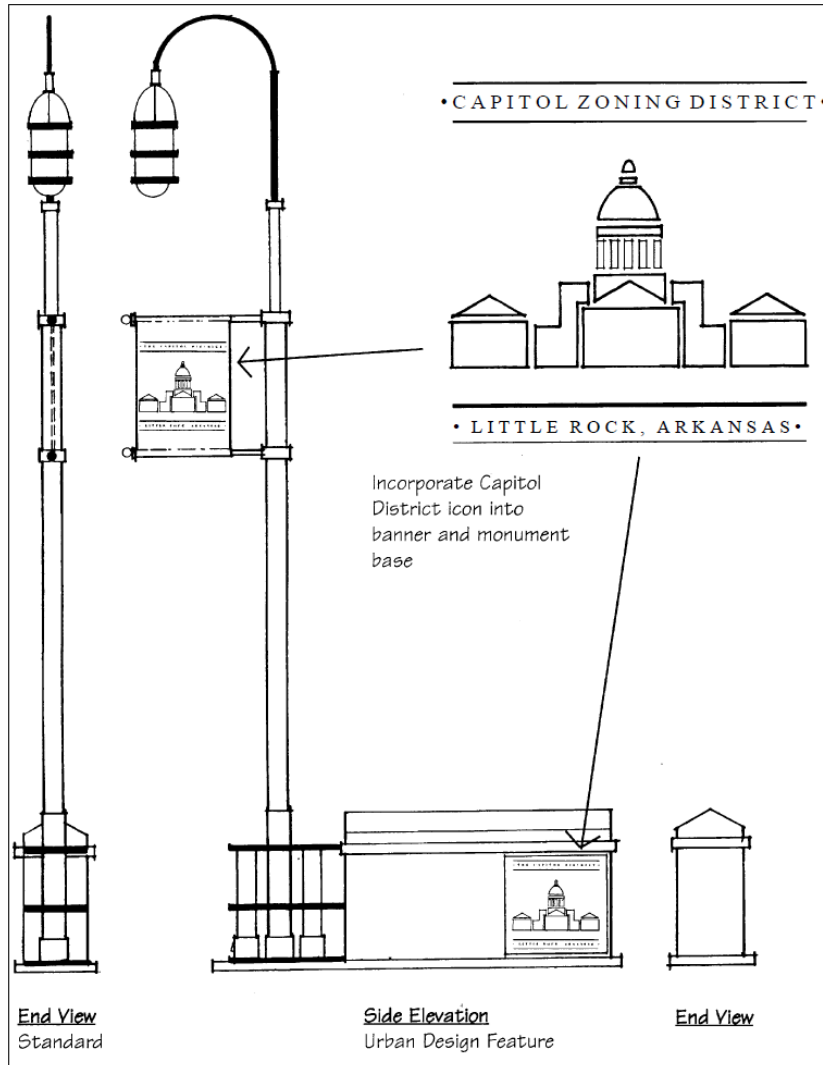

Figure 12. Streetscape design includes the introduction of street trees, furniture such as benches and waste receptacles and construction of planting areas, all coordinated to establish a distinct identity for the area.



Street furniture installed along eastern portions of Capitol Avenue serve as a model for improvements that should occur in the Capitol Area. The basic design elements established here should be continued.

D. Public Spaces

One of the key elements in the definition of character areas is quality and organization of parks and open space. Similar to the discussion of the character areas is the need to define the contribution of these public features to an area.

The area immediately around the Capitol and to the south and west has a character similar to many other state capitol areas. With the Capitol as the landmark or anchor structure, other significant public buildings are placed upon this established green. This “campus” character, provides a series of parks and open spaces with less formal connections between the buildings.

The areas east of the Capitol and south of Capitol Avenue reflect a lower to medium density urban grid character. To the north and northeast, more traditional blocks with buildings facing directly onto streets is an extension of a grid which extends into the downtown area. With the exception of the Capitol campus, there is no public open space within the Capitol Area neighborhood.

Recommendations:

1. Create new public gathering spaces within the Capitol Area neighborhood. Opportunities for pedestrian plazas exist within the Key Development Site at Woodlane and Capitol and at intersections along Victory Street See the map in Section 5-401 (A).
2. Create new parks, especially in the Union Station neighborhood where more intensive mixture of uses is encouraged. Take advantage of the topography in developing parks to provide a variety of experiences.

3. Establish strong landscaped edges adjacent to the campus area as well as with the transitional areas to the south, west and north.
4. Extend parks and open space opportunities to the northwest, towards emerging trails along the existing railroad corridors and the Arkansas River.
5. Create civic use opportunities for the Capitol Area. These parks will be vital to attract residents into the neighborhood.

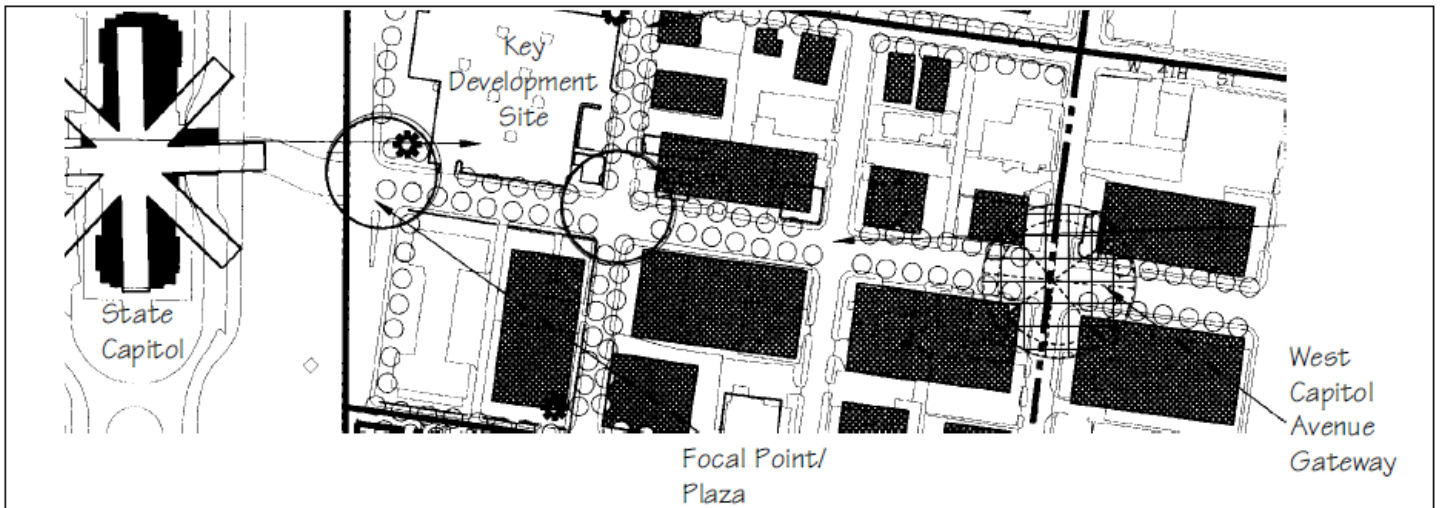

Figure 13. Create new public gathering spaces within the Capitol Area neighborhood. Opportunities for pedestrian plazas exist within the Key Development Site at Woodlane and Capitol and at intersections along Victory Street.

E. Memorial Plazas

Throughout the Capitol Area, many opportunities exist to install memorials. These may take the forms of commemorative plaques, monuments and works of art. Where feasible, these should be installed in small plazas that can be created as parts of individual site landscape designs. In this concept, standard street furniture elements, including lights and benches, frame a focal point which is the site for the installation of a memorial. Low scale plantings frame the site.

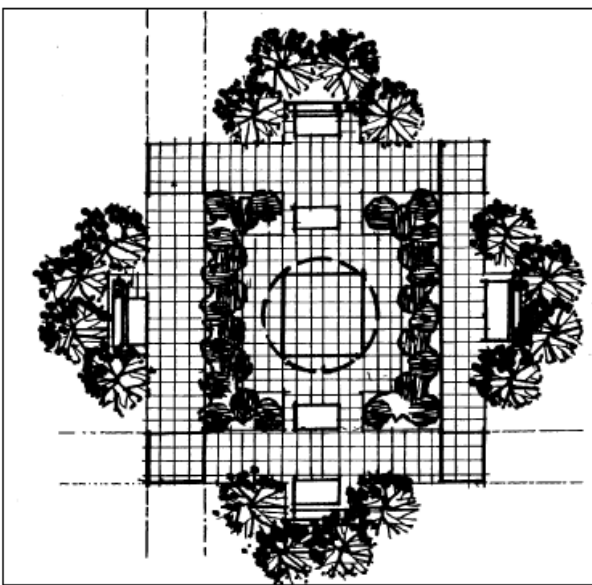

Figure 14. Prototype Plaza Design For a Memorial Installation.

F. Decorative Intersections

Decorative paving designs should be installed at the centers of the roadway intersections along Capitol Avenue. These designs should reinforce design themes established on the Capitol grounds. This concept interprets the design for a tiered fountain, adopted for installation at the entrance to the Capitol itself.

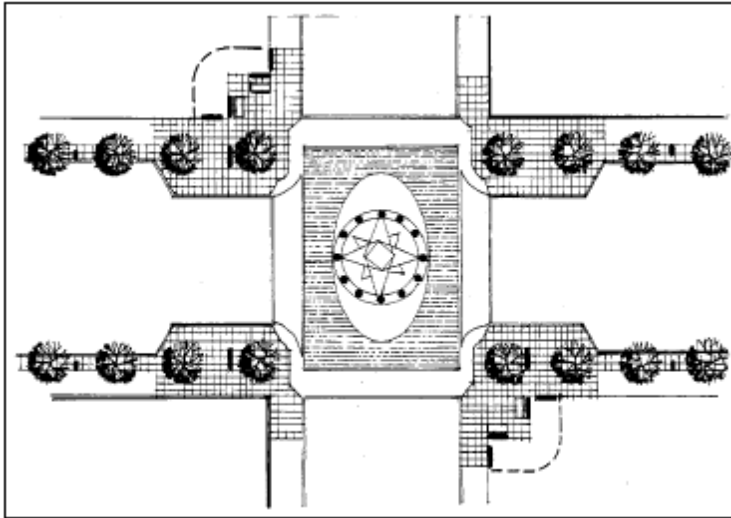

Figure 15. *A Prototype for Decorative Street Designs at Key Intersections*

G. A Kit of Parts for Streetscape Furniture

The City of Little Rock has adopted a design vocabulary of streetscape furniture for Capitol Avenue. This includes decorative streetlights, paving, benches and waste receptacles. That vocabulary should be extended into the Capitol Zoning District Area. In general, these streetscape elements should be installed in a manner similar to that used along the eastern portions of Capitol Avenue. However, it is important that these furnishings be organized into groupings, when feasible, that will help to establish a “critical mass” of street furniture elements, to maximize their visual impacts. This is particularly important to do in the blocks closest to the Capitol building.

Figure 16 illustrates a framework structure that could be used to help organize these and additional street furnishings in a manner that will maximize their impacts: **(A)** A street light is combined with a foundation structure that provides a significant mass. Banners are also used to add accents. **(B)** A low scale monument sign or landmark identifier is added to provide interpretive information and guidance. **(C)** A bench is added to the armature. **(D)** Large flags are mounted on poles in a similar armature arrangement to be installed at key intersections and gateways.

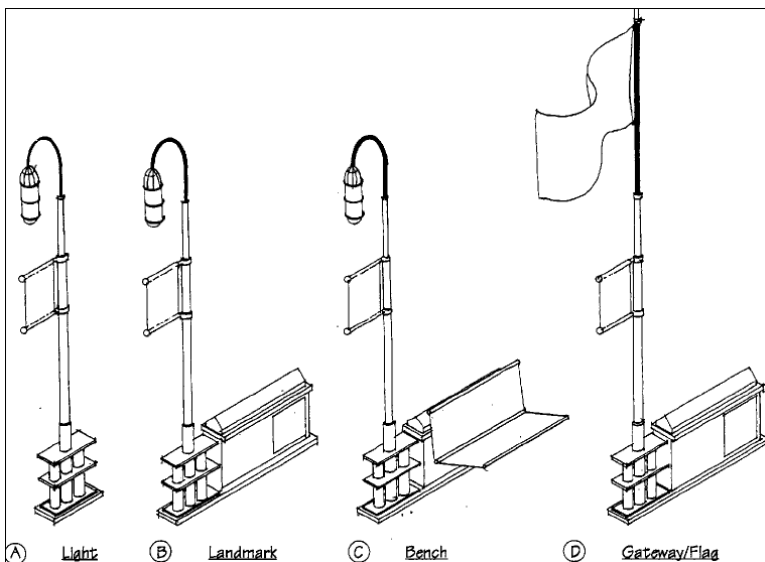

Figure 16.

H. Scheme A - Linear Plaza

In this approach to plaza designs at the intersection of Woodlane and Capitol Avenue, a “conservative” scheme is used. A plaza would be installed at the northeast and southeast corners which would reflect the axis of the Capitol building. A smaller building, perhaps a transit facility, would be located along Woodlane. Two smaller structures with visitor information services would be installed at the southeast corners. These would reflect the monumental planter designs proposed for the base of the steps of the Capitol grounds themselves. This would visually link the plaza to the Capitol grounds.

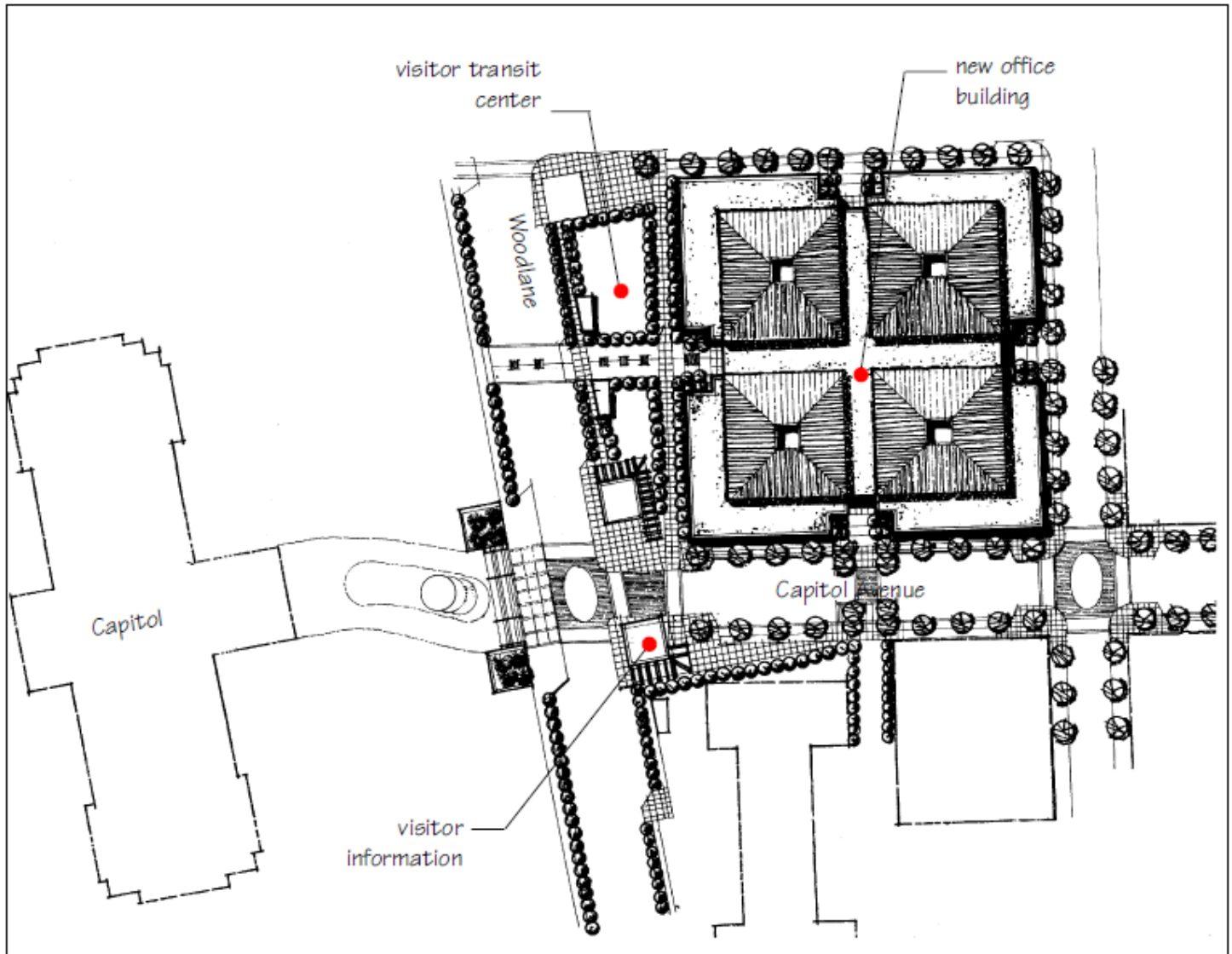

Figure 17.

I. Scheme B - Corner Plaza

In this conceptual sketch, the transition between the downtown street grid and the orientation of the Capitol building is accommodated, primarily, in a corner plaza designed for the northeast corner of the intersection of Woodlane and Capitol Avenue. A key feature is a traffic oval which causes automobiles to circulate around a central landscape element that would be positioned on axis with the Capitol building. This, visually, shifts the focus of the intersection for the “askewed” angle of the streets themselves. The central axis of the Capitol entrance would extend east across Woodlane to a focal point at the center of the plaza, on the northeast corner. An office building would occupy the remainder of the site. The facades of the south and west elevations would be angled to reflect the two differing street grids.

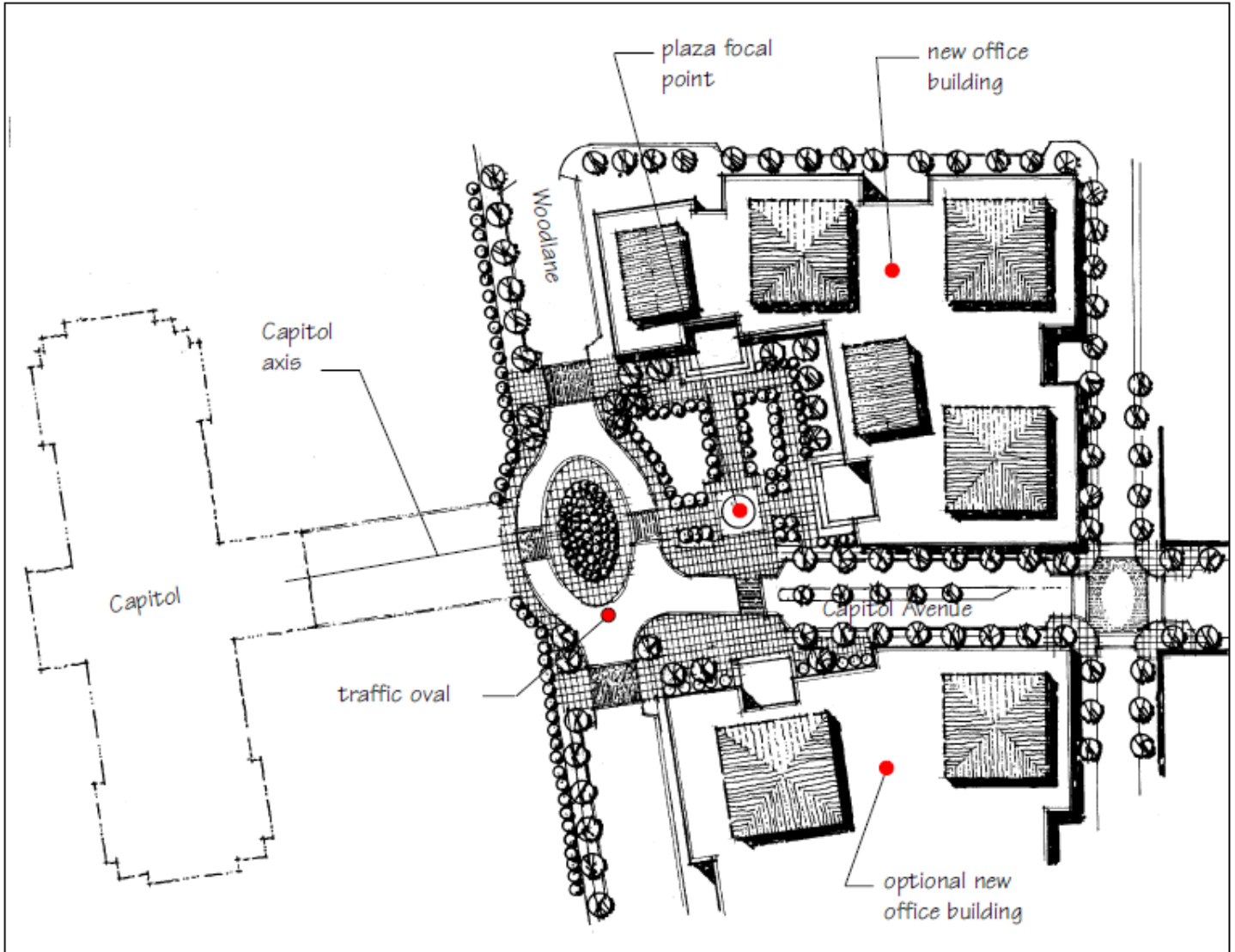

Figure 18.

J. Scheme C - Ceremonial Plaza

In this concept, plazas on the east side of Woodlane are aligned to reflect the orientation of the front of the Capitol building. A focal point is created, in the plaza, on the north edge of Capitol Avenue that aligns with the central axis of the Capitol building. Ceremonial steps on the western edge of Woodlane would establish a transition for crosswalks that would connect to the east side of the street. An office building with parking structure included would occupy the bulk of the site at the northeast corner of Capitol and Woodlane.

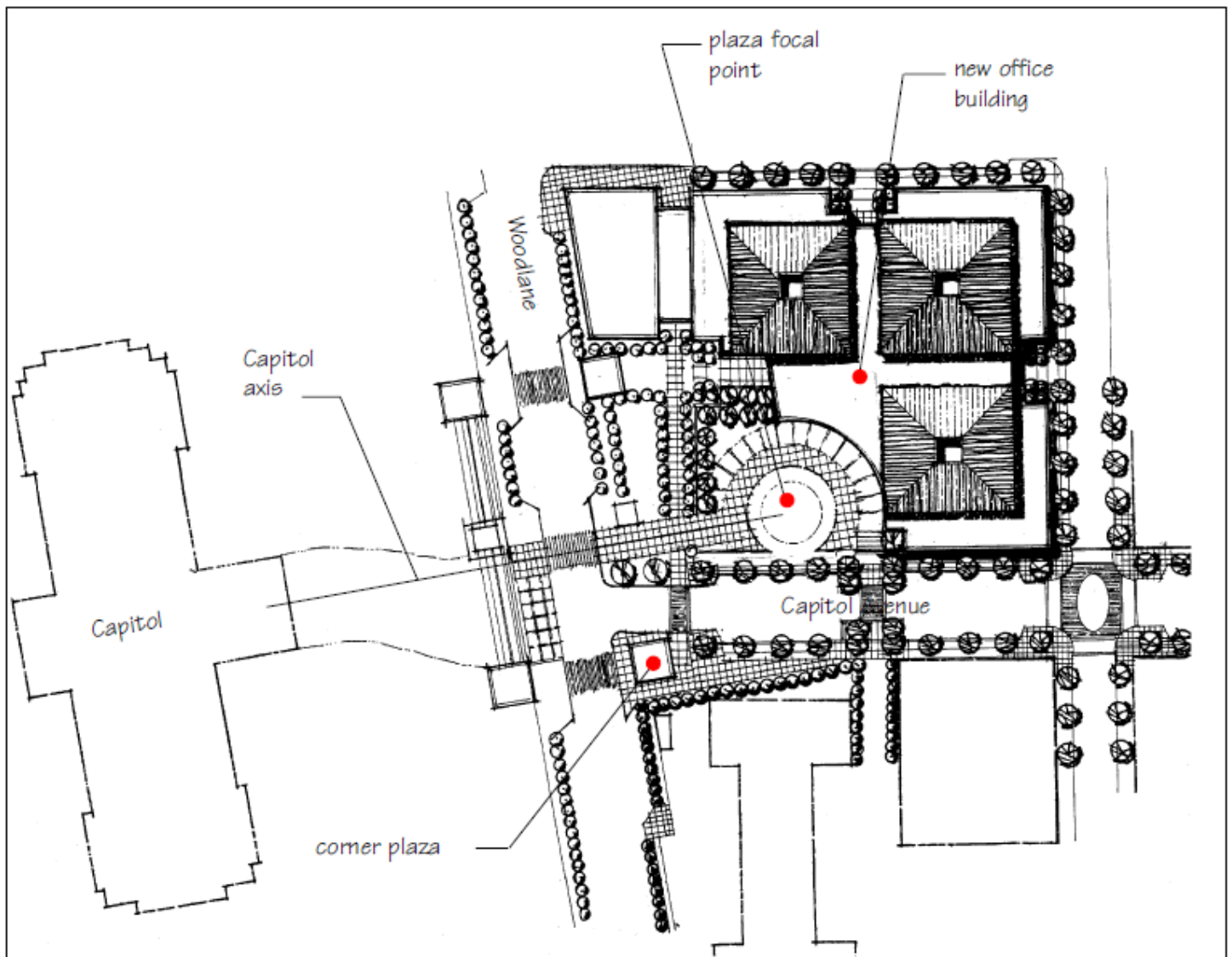

Figure 19.

K. Circulation Patterns

The map in Section 5-401 (B) combines circulation patterns for automobiles, pedestrians and public transit vehicles. Key pedestrian routes lie along Third Street, Seventh Street, Capitol Avenue and Victory Street, as well as Woodlane. A portion of 4th Street just north of the Capitol is also a key pedestrian connection between the Capitol campus and the commercial blocks of the Capitol Area, however it is active with automobile traffic and crossing points are difficult for pedestrians. Numerous curb cuts for on-site parking lots also discourage pedestrian activity.

Portions of a recreational trail exist along the railroad edge and other planning efforts suggest the potential to extend this system. This may provide connections to other nearby amenities for pedestrians and bicyclists. In terms of automobile circulation, vehicles travel relatively unimpeded throughout the area, although awkward intersections at Union Station and just north of the Capitol do limit movement to some extent. All streets provide two-way travel, except that 4th and 6th Streets serve as a one-way couplet.

A major entry point into the area is at the intersection of Interstate I-630 and Woodlane. From this point, state employees turn west into the Capitol campus. Others filter through various streets to a variety of destinations in the neighborhood. Another key entry point is at the intersection of Cross and Cantrell Road. Yet another entry point that is increasing in importance is the intersection of Markham and Cross. These provide opportunities to establish an identity for the area through streetscape design improvements.

Third Street serves as a major route linking the Hillcrest neighborhood to the west with downtown Little Rock. It therefore offers opportunities for uses that would benefit from such an exposure. A string of key intersections lies along Victory Street. These are symbolic entry points into the core of the area and serves as key decision-making places, where motorists must make turning movement decisions. These also provide opportunities for special streetscape design treatments.

Recommendations:

1. Automobile circulation patterns should be managed such that convenient access into the area is maintained while respecting goals for enhancing pedestrian movement opportunities.
2. Key intersections should be designed to assist motorists in making turning movement decisions and to highlight entry points.



Because of its location along the I-630 corridor and along the Missouri Pacific Railroad, the Capitol Area has few vehicle, pedestrian, transit and bicycle connections with areas of the city to the north, south and west.

L. Circulation and Access

Because of its location along the I-630 corridor and the Missouri Pacific Railroad, the Capitol Area has few vehicle, pedestrian, transit and bicycle connections with areas of the city to the north, south and west. There are some significant traffic circulation problems that will require attention. The transition from 4th Street/ Woodlane/High Street is awkward and intimidating to the pedestrian. State employees often take the “back door” route to and from work on 2nd Street (under 3rd Street) along the railroad tracks, north on Victory and east on Markham. The intersection of Markham and Victory is awkward with access to the Union Station parking lot and the parallel street directly south of it.

Recommendations:

1. Endorse a pedestrian friendly environment within the area.
2. Establish strong pedestrian and bicycle connections into and through the area.
3. Develop an overall transportation master plan to resolve transportation conflicts.

M. Martin Luther King Jr. Drive Improvements

Opportunities exist to establish a special scenic overlook and trailhead at the northern end of Martin Luther King Jr. Drive. A plaza could be constructed here that would provide new opportunities overlooking the lands beyond the Missouri Pacific railroad line, as well as a dramatic view southward along MLK Jr. Drive to the front of the Capitol building. Views of the Union Station area would also be available here. Special streetscape improvements should be considered along MLK Jr. Drive to encourage walking from the Capitol complex down to the Union Station area and to this viewpoint. Therefore, streetscape improvements along this route should be a high priority. In addition, the intersection of MLK Jr. Drive with Third Street should be emphasized as a special intersection. Opportunities to extend the boulevard image that exists south of Third Street should be explored so that this same image could be extended to the north. The plaza should include connections to the potential regional trail along the Missouri Pacific railroad line and it is an ideal site for a memorial or public art installation.

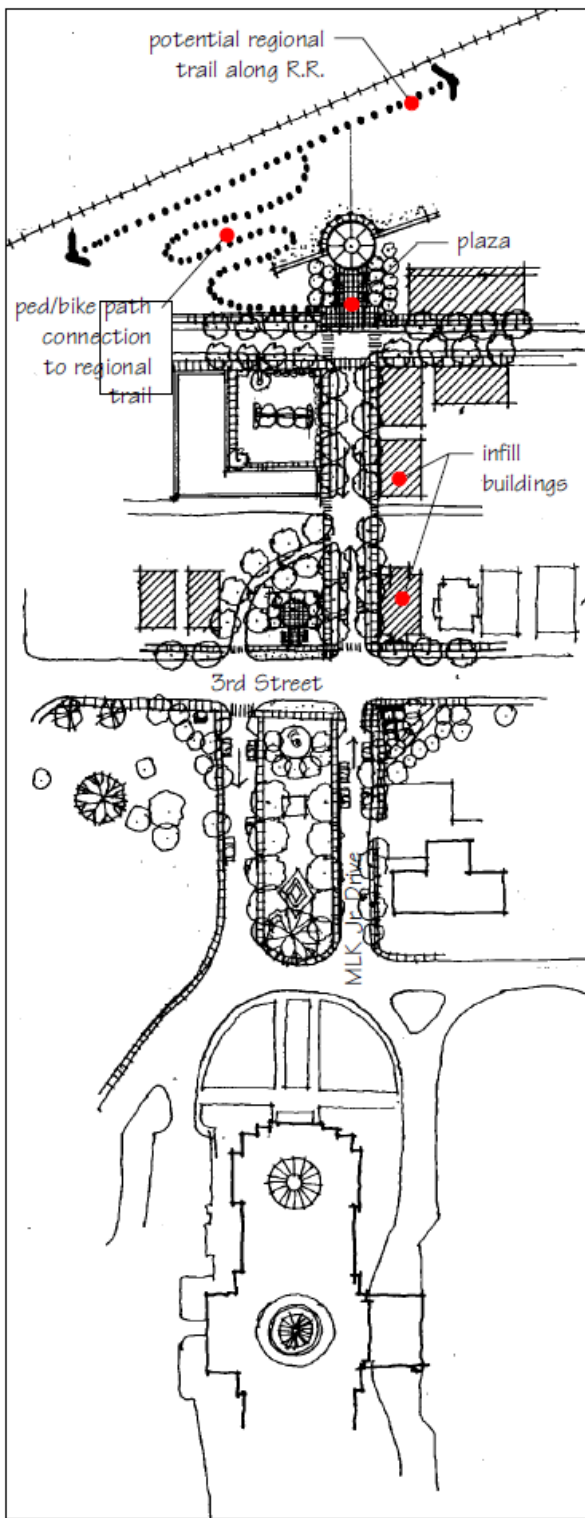

Figure 20. *Potential Martin Luther King Jr. Drive improvements include establishing an overlook at the north end of the street, connections to existing trail system and memorial opportunities.*

N. Transit

There are limited transit opportunities in the Capitol Area. The existing predominance of parking lots is indicative of a heavy dependence on the automobile. The CATA does run three routes through the Capitol Area, but utilization rates are low.

Recommendations:

1. Reestablish the circulator bus route between the Capitol and downtown.

2. Evaluate the potential for additional transit routes to serve the Capitol Area.

O. Parking

The State employee base within the Capitol Area requires a sizable parking reservoir and visual impacts of parking within this area are significant. As an example, buildings have been removed for surface lots and automobiles can be observed parked in front yard setbacks. The introduction of diagonal parking in the front yard of the Capitol Building along Woodlane is another indication of the severity of the problem. Given the impacts of parking within this area, it is important to develop a strategy for both easy access and predictable parking opportunities.

Recommendations:

1. Create a partnership between the City and the State that is dedicated to implementing a parking plan that recognizes the need to appropriately accommodate parking and that places parking convenient to other modal provisions (i.e. near transit stops, trail connections, etc.).
2. Identify potential locations for structured parking.
3. Adopt design guidelines which minimize the visual impacts of parking.
4. Locate surface lots behind buildings.

THIS PAGE INTENTIONALLY LEFT BLANK.

SECTION 5-401 CAPITOL AREA MAPS

A. Master Plan Map This map shows the locations of many of the recommendations described in this article.

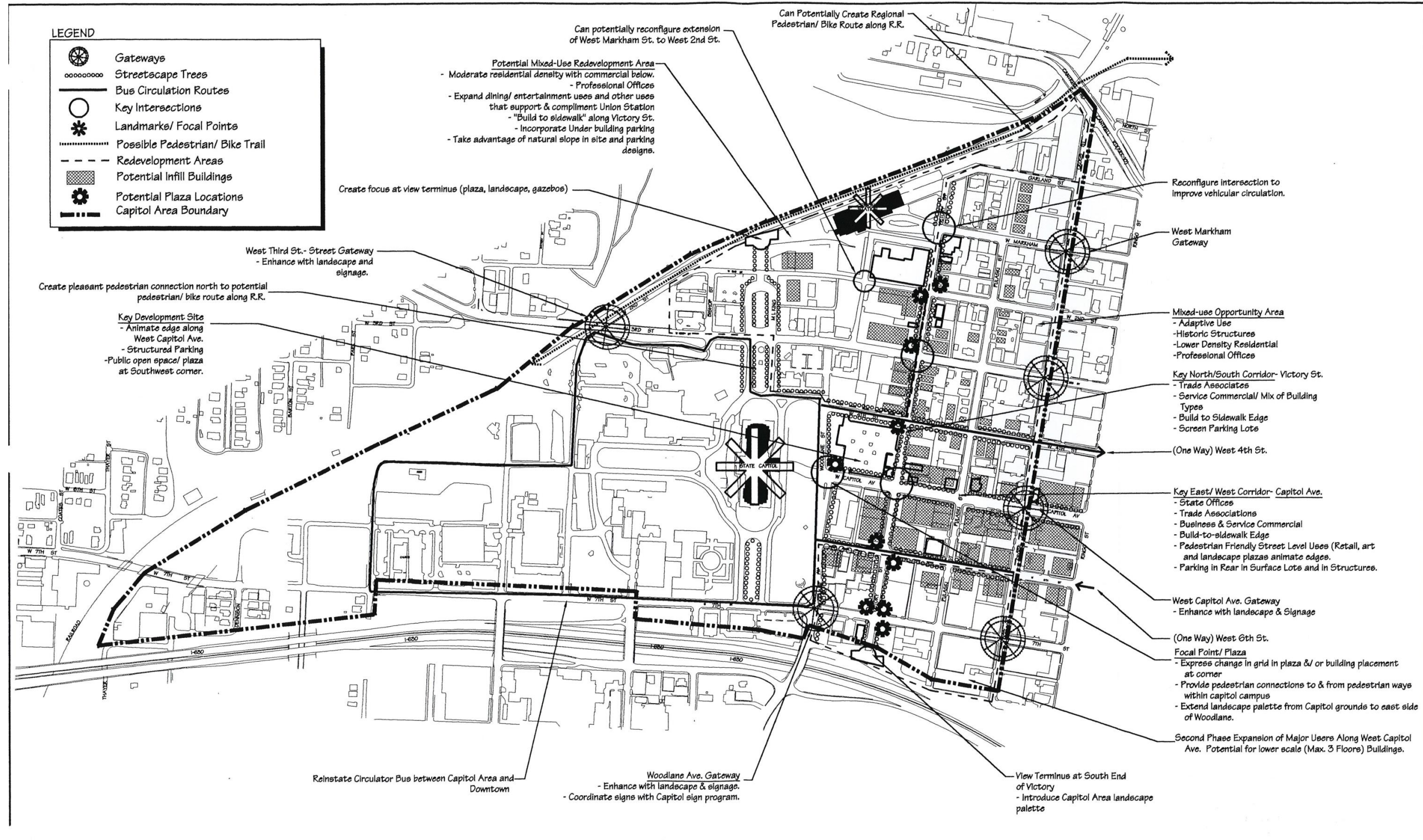

<p>JAMESON ARCHITECTS P.A. SUITE 205 2701 KAYANAUGH BOULEVARD LITTLE ROCK, ARKANSAS 72205 501 666-6600 - FAX 666-5177</p>	<p>CONSULTANTS Winter & Company Planning Consultants Public Officials</p>	<p>0 100' 200' 300' 500' 1" = 500'</p>	<p>CAPITOL AREA FRAMEWORK MAP PLANS</p>	<p>ORDINANCE PROJECT CAPITOL ZONING DISTRICT CAPITOL ZONING DISTRICT COMMISSION LITTLE ROCK, ARKANSAS</p>	<p>DATE: 28 AUGUST 88 JOB NO.: 88-101 FILE: FRAMEWORK REVISIONS:</p>	<p>DRAWING NO. C-2</p>
------------------------------------------------------------------------------------------------------------------------------------------------------	--------------------------------------------------------------------------------------------------	--------------------------------------------	----------------------------------------------------	------------------------------------------------------------------------------------------------------------------------------	----------------------------------------------------------------------------------	-----------------------------------

B. Topography Map

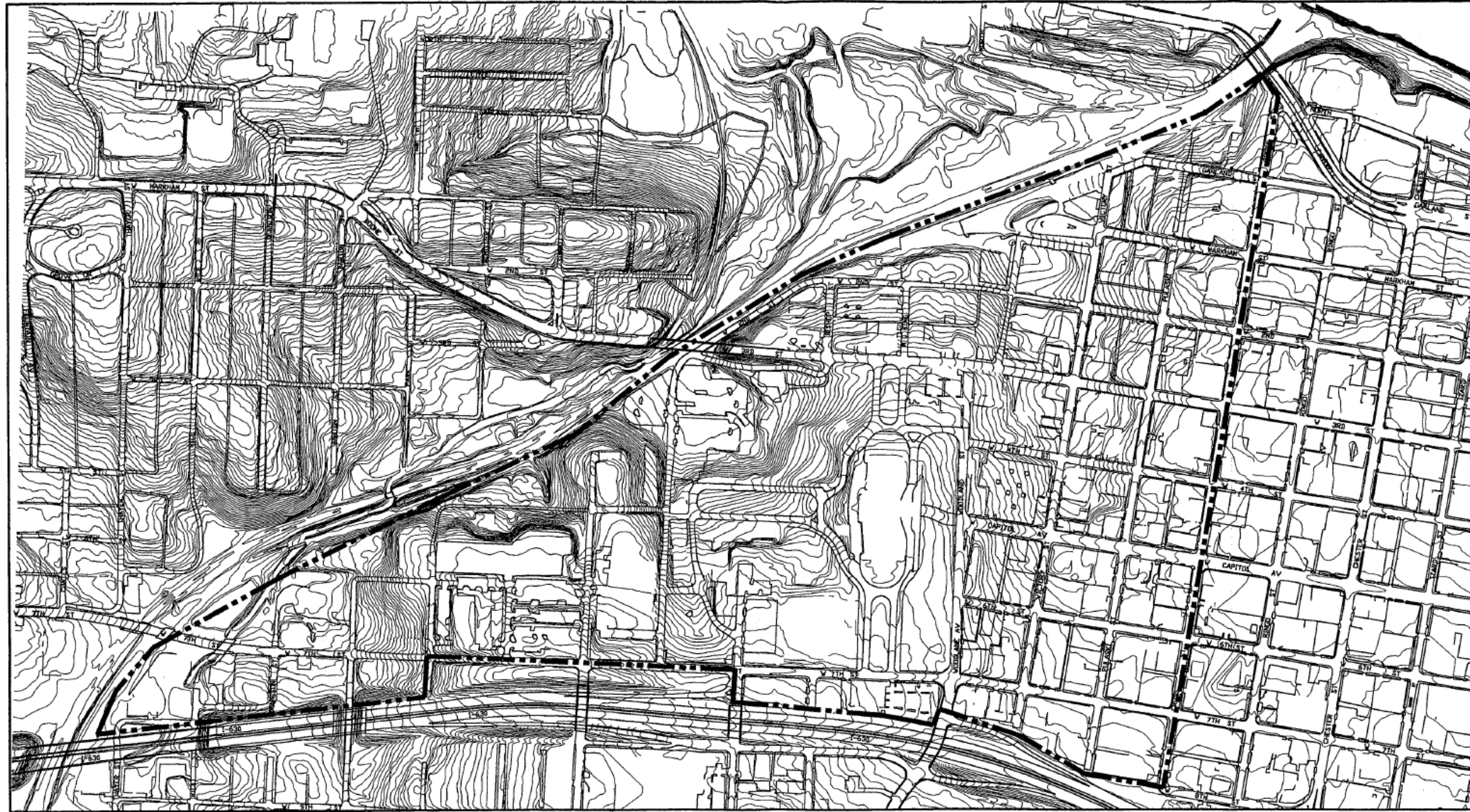

JAMESON
 ARCHITECTS P.A.
 SUITE 205
 2701 KAVANAUGH BOULEVARD
 LITTLE ROCK, ARKANSAS 72205
 501 666-6600 • FAX 666-5177

CONSULTANTS
Winter & Company
 Planning and Development Consultants
 10000 N. UNIVERSITY
 LITTLE ROCK, ARKANSAS 72205
 501 666-6600 • FAX 666-5177

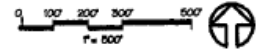

CAPITOL AREA
TOPOGRAPHY

ORDINANCE PROJECT
CAPITOL ZONING DISTRICT
 CAPITOL ZONING DISTRICT COMMISSION
 LITTLE ROCK, ARKANSAS

DATE: 18 AUGUST 86
 JOB NO: 86-101
 FILE: C-3
 REVISIONS:

DRAWING NO.
C-3

C. Figure Ground and Views Map

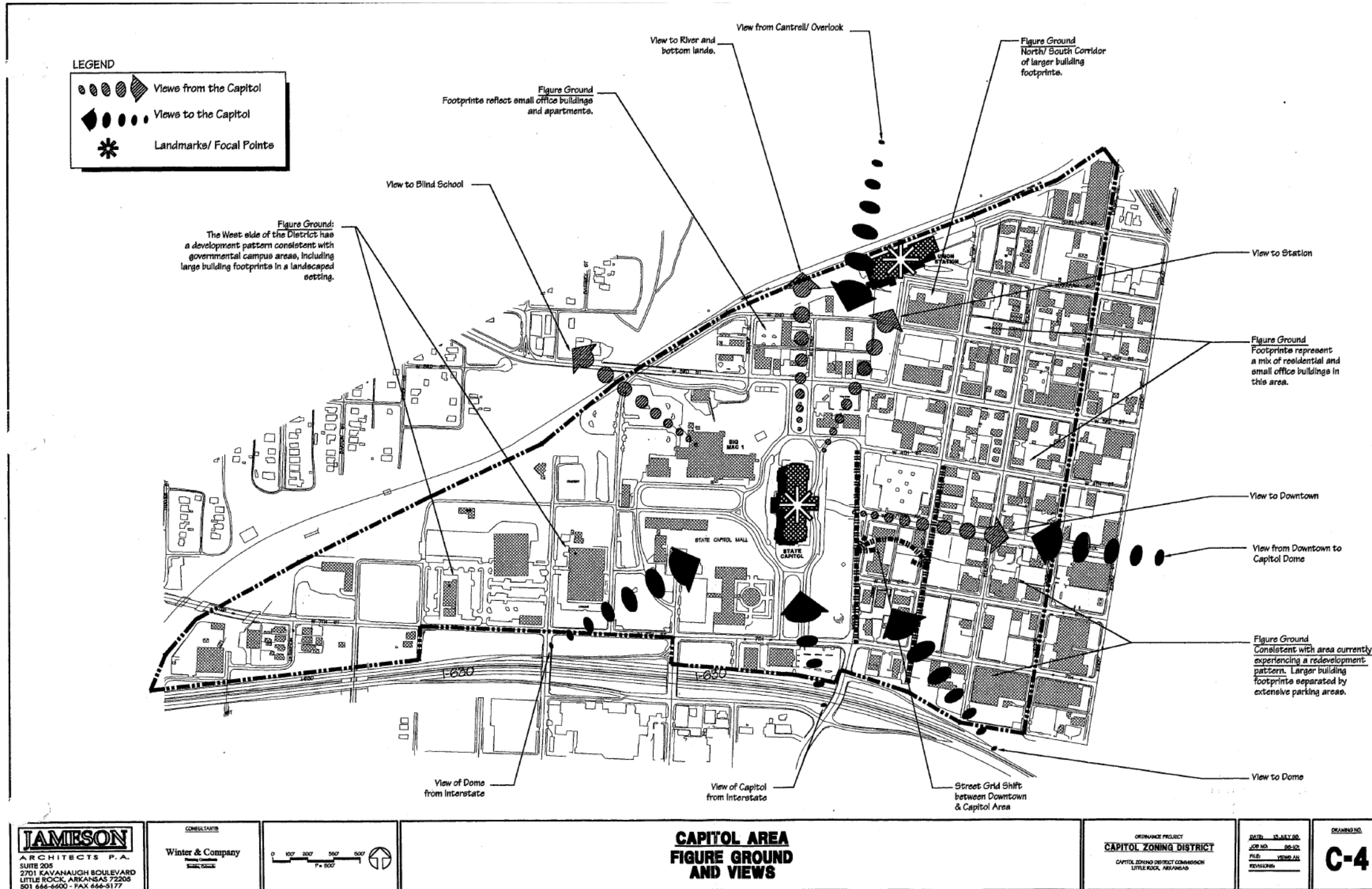

JAMESON
ARCHITECTS P.A.
SUITE 205
2701 KAVANAUGH BOULEVARD
LITTLE ROCK, ARKANSAS 72208
501 666-6600 • FAX 666-5177

CONSULTANTS
Winter & Company
PLANNING CONSULTANTS
ARCHITECTS

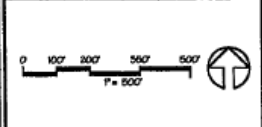

**CAPITOL AREA
FIGURE GROUND
AND VIEWS**

ORDINANCE PROJECT
CAPITOL ZONING DISTRICT
CAPITOL ZONING DISTRICT COMMISSION
LITTLE ROCK, ARKANSAS

DATE: 12.18.10
JOB NO.: 08-101
FILE: VIEWS.A11
REVISIONS:

DRAWING NO.
C-4

D. Transportation Routes Map

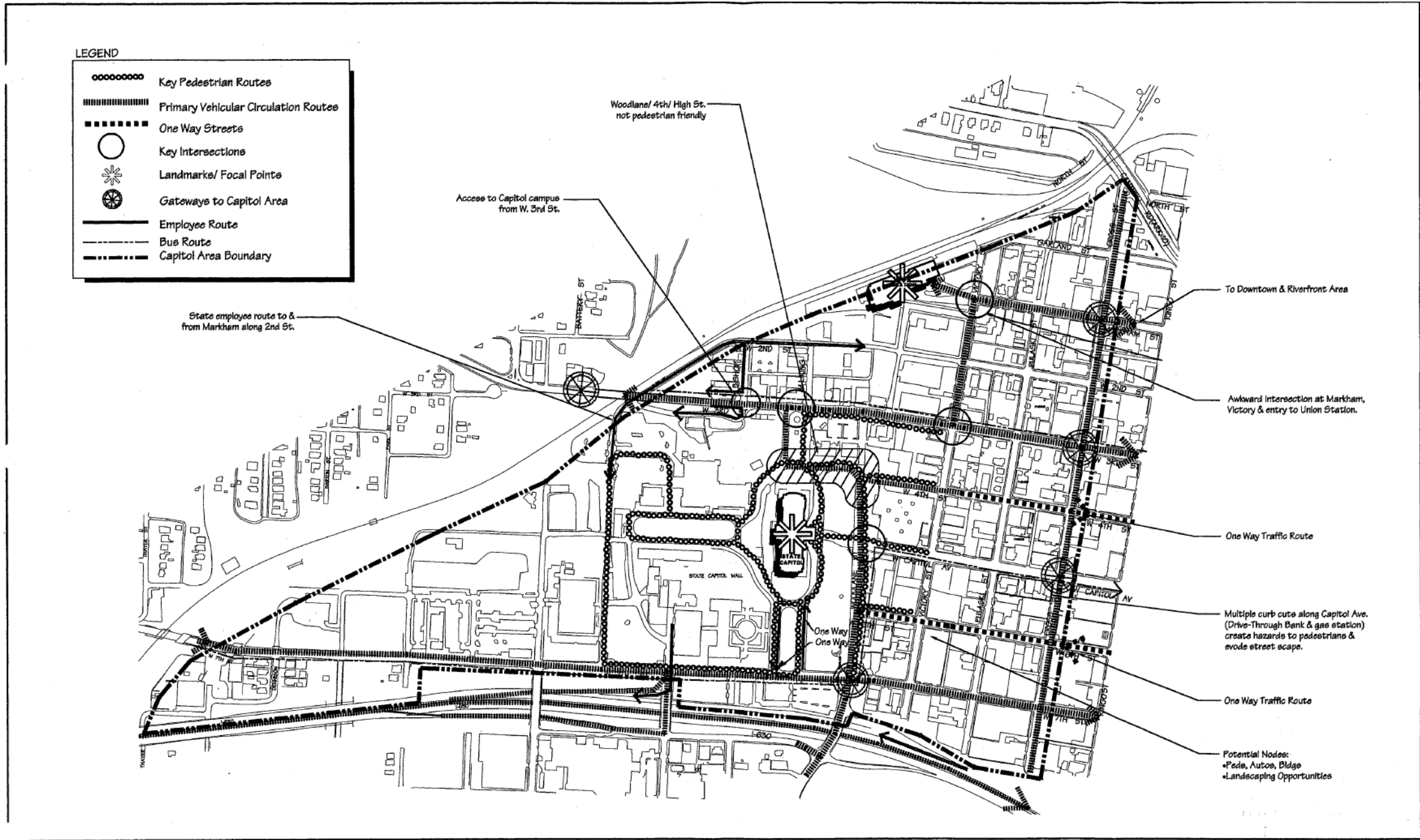

JAMESON
ARCHITECTS P.A.
SUITE 205
2701 KAVANAUGH BOULEVARD
LITTLE ROCK, ARKANSAS 72205
501 646-6600 - FAX 646-5177

CONSULTANTS
Winter & Company
Planning Consultants
ARCHITECTS

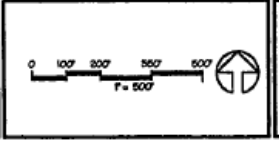

**CAPITOL AREA
AUTO/ PEDESTRIAN
ANALYSIS**

ORDINANCE PROJECT
CAPITOL ZONING DISTRICT
CAPITOL ZONING DISTRICT COMMISSION
LITTLE ROCK, ARKANSAS

DATE: 10 AUGUST 06
JOB NO.: 06-101
FILE: AUTO/AM
REVISIONS:

DRAWING NO.
C-5

ARTICLE SIX

MANSION AREA MASTER PLAN

SECTION 6-101 INTRODUCTION

In 1975, concerned about protecting the character of the environs of the Governor's Mansion, the General Assembly defined a four to five block radius around the executive residence as a place where land use zoning regulations would be administered by the state. It defined land use categories and mandated a design review process to monitor the character of development in the area and also established the Capitol Zoning District Commission to administer the regulations.

The goal of these actions was in part to enhance the character of the Mansion Area neighborhood. They also were motivated by a desire to preserve the historic resources of the neighborhood, which represent some of the finest in the state.

The majority of the area is residential in character and in use. Single family structures dominate the scene, although several of these have been converted into multifamily dwellings. Main and Broadway were defined as commercial corridors, with some portions established to develop in a traditional "main street" context, while other parts were to respect the traditional residential character as they adapted to new uses.

The system served to create a climate for investment in the area. Property owners could be assured that, when they invested in their properties in a manner that was compatible with the historic character, others around them would be compelled to do so as well.

Over the past forty years, the program has been very successful. Property owners have rehabilitated numerous houses throughout the area, and demolition of historic buildings has been substantially diminished. Many homes that had been subdivided into apartments have been returned to single family use.

The success of the program is noticeable on virtually every residential block in the neighborhood. A comparison with photographs taken when the commission was first established dramatically demonstrates improvement in the neighborhood. Original details have been restored and inappropriate alterations have been removed on many houses. Improvements also have occurred in the commercial areas, although perhaps not quite as successfully as in the residential blocks. In these areas, the automobile dominates the scene, with exposed parking and buildings set back from the street.

By 1997, the Commission recognized that the master plan and design guidelines for the area required updating, in part to respond to changing development trends and loss of less significant but historic structures. While basic rehabilitation principles had been the focus of the earlier design guidelines, they did not specifically address many of the restoration issues that property owners raised. Additional clarity was needed in these areas. Increasing interest in new construction made it clear that more specific guidelines for new construction also were needed. With regard to land use, some specific issues had also arisen, such as how to treat historic commercial structures that are located where commercial uses currently would not be permitted.

The Commission also recognized that the original plan had essentially focused on protection strategies that would maintain the traditional character of the neighborhood. Today, it is recognized that a more proactive stance is now needed to help the neighborhood realize its potential as a distinguished foreground for the Governor's Mansion.

The Scope of the Plan

The Master Plan sets out the basic land use policies for the Mansion Area, including the types of uses to be permitted in each zoning category, and establishes a foundation of goals that underlie the accompanying standards. In addition, recommendations for improvements in the public sector are made. These focus on streetscape construction that would enhance the identity and function of the neighborhood and would require cooperation between the state and the City of Little Rock.

SECTION 6-102 The Planning Process

In order to develop the Master Plan, a series of workshops were conducted in the spring and summer of 1998 with local residents, property owners, business owners, elected officials, CZDC staff and advisory committee members to discuss the potential future character for the Mansion Area. The insights provided by the participants assisted the team of consultants and CZDC staff in getting to the root of many development problems facing the area. This helped to develop appropriate policy and design recommendations and provide a framework for future developments. Some of the highlights of the workshops included discussion of the following:

CHARACTER-DEFINING FEATURES

- The Governor's Mansion
- Large collection of restored and preserved historic buildings

NEIGHBORHOOD TRENDS

- Diversity (economic, racial, age)
- Increasing number of renovation and restoration projects
- Increasing amounts of landscaping
- Owner-occupied homes
- Families with children
- Single family use (vs. multi-family)
- Sense of neighborhood

KEY NEIGHBORHOOD ISSUES

- Lack of commercial maintenance
- Lack of neighborhood convenience services
- Recent infill development out of character with neighborhood
- Unprotected front door between Mansion Area boundary and freeway
- Commercial impacts (noise, traffic)
- Inappropriate zoning/uses
- Inappropriate building alterations
- Parking in front yards
- Lack of sidewalk maintenance (who's responsible?)
- Adjacent residential uses to east and west similar in character



The Governor's Mansion was identified as one of the most important character-defining features of the neighborhood.

SECTION 6-103 HISTORIC OVERVIEW

The neighborhood encompassed by the Mansion Area developed during the late 19th and early 20th centuries and is today the second-oldest residential neighborhood in Little Rock that survives largely intact. In recognition of its historical and architectural significance, a large portion of the neighborhood is listed in the National Register of Historic Places as the Governor's Mansion Historic District.

The history of the Mansion Area begins shortly after the Civil War, when Little Rock's population was growing rapidly and new technology was bringing dramatic changes to the daily lives of the city's residents. It was during this era of growth and change that the neighborhood began developing.

Technological advances—paved streets, water and sewer systems, electricity, telephones, streetcars— made life easier and more pleasant for Little Rock residents. Streetcars, in particular, enabled the city to expand by providing residents a cheap and convenient means of transportation from home to work or shopping.

There was no streetcar when Peter Hotze built the oldest house that still stands in the Mansion Area. The “Old” Hotze House at 1620 Main Street was constructed in 1869 at what was then the southernmost edge of Little Rock.

Rosewood and the Blind School

A short distance from the Hotze House was the former country estate of William Savin Fulton, Arkansas’s last Territorial Governor and one of the first two U.S. Senators elected when Arkansas became a state in 1836. The Fulton estate, known as “Rosewood,” stood approximately where the Arkansas Governor’s Mansion does today, at 18th and Center Streets. In the same year that Peter Hotze built his house, Rosewood was acquired by the state as the site for the new “Arkansas Institute for the Education of the Blind.”



This is a 1890s view looking north from the tower of the Blind School. Churches and grand homes dominated the scene in the early years of what is now the Mansion Area and surrounding environs.

Neighborhood Expansion

In the 1880s, significant numbers of new houses began joining the Hotze House to create a residential neighborhood around the Blind School. Most of the first neighboring buildings were modest workers’ cottages, but a few were more substantial two-story frame dwellings. Frequently, these early houses were builders’ versions of the Italianate style.

At the corner of 17th and Spring Streets, one block north and one block west of the Blind School, construction of Trinity Episcopal Cathedral began in 1884. The presence of this attractive and important religious institution may have served to persuade some of Little Rock’s more affluent residents that the neighborhood around the Blind School would be a good place to live. In 1884, real estate broker W.J. Turner hired an architect, Thomas Harding to design a large brick residence in the fashionable Queen Anne style. The house was constructed directly opposite the Blind School, at the northwest corner of 18th and Center Streets.



W. J. Turner's residence

Construction of W. J. Turner's residence was followed by the building of other large, architect-designed homes. By the 1890s, the area around the Blind School was well on its way to becoming Little Rock's "best" neighborhood, the one most frequently selected by prominent and well-to-do families when looking for places to build new homes.

Aiding in the neighborhood's development was expansion of Little Rock's streetcar system, which had started in 1877 with mule- and horse-drawn cars but began using electric cars in 1891. By 1893, the Blind School neighborhood was served by streetcars that carried passengers south on Main Street to 23rd Street. Routes also crossed the neighborhood east to west on 15th and 23rd Streets. Another route ran south on Arch Street from 15th to 23rd. New homes were often built on or near the streetcar lines, and small commercial districts developed at two streetcar stops, one at 15th and Gaines Streets and another at 23rd and Arch Streets.

The neighborhood around the Blind School remained one of Little Rock's best through the 1920s, but by this decade, most of the neighborhood's building lots were occupied, and construction of new middle and upper-middle class houses had moved west and north into the neighborhoods now known as Central High, Hillcrest and the Heights.

Early Decline

In the 1930s and 1940s, many large homes in the Blind School neighborhood were converted to use as apartments or rooming houses, prompted first by the economic hardships of the Depression and then by demand for housing during and immediately after World War II. The Blind School itself left the neighborhood in 1939, eventually to be replaced by the Arkansas Governor's Mansion, first occupied in 1950 by the family of Governor Sid McMath.

Despite the prestige of the Governor's Mansion, most of the neighborhood's remaining middle-class residents moved away, and houses began to deteriorate seriously, often after being divided for multi-family use. Institutional uses also took over some of the neighborhood's largest and most significant historic homes. During the late 1960s and early 1970s, commercial uses led to the demolition of several houses on Broadway. During the same period of time, the Little Rock Housing Authority demolished a block of houses between Broadway and Arch to erect the Fred W. Parris Towers, a high-rise apartment building for the elderly, completed in 1973.

Revitalization

The assault on Broadway proved to be a turning point for the neighborhood. Residents formed the Broadway Neighborhood Association (BNA) in the early 1970s to save the once-lovely thoroughfare from further demolition and commercialization. The Quapaw Quarter Association, a preservation advocacy organization, turned to the Governor and General Assembly for help. In 1975, the state created the Capitol Zoning District Commission with jurisdiction over the Mansion Area, offering encouragement to families who wanted to invest in the rehabilitation of the neighborhood's late 19th and early 20th century houses.

The Quapaw Quarter Association continued to assist in stabilizing and promoting the neighborhood by conducting an architectural survey of the area in 1976 and 1977. As a result, about twenty blocks immediately surrounding the Governor's Mansion were listed in the National Register of Historic Places in 1978 as the Governor's Mansion Historic District. A new survey of the neighborhood in 1987, co-sponsored by the Quapaw Quarter Association, the City of Little Rock and the Arkansas Historic Preservation Program, led to expansion of the historic district, which now comprises about sixty-five square blocks. While the Governor's Mansion Historic District and the Mansion Area are not contiguous, they overlap one another to a considerable extent.

Between historic preservation efforts and stable zoning, the Mansion Area has witnessed enormous improvement since the 1970s. Some 300 of its buildings, mainly houses, have been rehabilitated, representing millions of dollars of private investment in a neighborhood that was once in severe decline. Well-maintained single-family homes are now the rule rather than the exception in the Mansion Area. The Capitol Zoning District Commission and the zoning it administers have been critical factors in this dramatic transformation.



The first Hotze house at 1620 Main Street.



An 1890s view of Center Street, looking south from 16th Street to the Blind School.

SECTION 6-201 MANSION AREA GOALS AND RECOMMENDATIONS

It is important to understand the scope of this Master Plan. It provides a broad view of how a variety of both public and private design and planning improvements may be coordinated such that the benefits of those investments may be maximized. The Master Plan establishes a road map for planning and design work, indicating its general scope and character. It establishes a direction for public and private improvements, but it does not provide specific design solutions. Details of designs for individual plan elements should be refined as each component moves into an implementation phase.

The Mansion Area Master Plan defines urban design policies for the Mansion Area and establishes a framework for implementing specific design improvements that will establish a distinct identity for this vital Little Rock neighborhood. The recommendations foster good design choices and sound development strategies for reinvestment and enhancement of the public nature of the Mansion Area. These recommendations provide for the continued accommodation of current uses and changing land use patterns within the neighborhood.

A. Mansion Area Goals

The Commission holds these planning and design goals for the Mansion Area:

1. To preserve the character of the Mansion Area neighborhood and individual historic buildings

The preservation and restoration of significant buildings in the Mansion Area, as well as the preservation of the overall character of the Mansion Area, is the primary goal of this plan.

2. To revitalize existing housing, to promote new infill housing development and promote diversity among residents

Enhancing the social and economic diversity of the neighborhood is very important to many area residents.

3. To rehabilitate dilapidated historic structures in and around the neighborhood

Protecting the environs of the Governor's Mansion is the primary charge of the CZDC; therefore, the rehabilitation of dilapidated and neglected historic structures is an important goal.

4. To create an improved image and stronger sense of identity

Neighborhood residents already feel a strong sense of identity but wish this image to extend throughout the community of Little Rock.

5. To continue to develop a more family-friendly environment for residents and visitors alike

Providing such elements as landscaping, period lights, trails, parks and medians might help to accomplish this goal.

6. To establish new and to better define existing gateways into the neighborhood

Letting visitors know when they enter and leave the character areas of the Governor's Mansion neighborhood is very important to residents.

7. To create a mixture of uses throughout the neighborhood

Providing convenient neighborhood services is vital to the long-term success of any community.

8. To enhance the pedestrian experience throughout the commercial areas

Streets should be places that are active with pedestrians, where walking is a pleasant experience. The automobile should appear subordinate to other uses. Therefore, parking and circulation requirements should be accommodated in a manner that supports the desired uses for the neighborhood.

9. To establish a sense of visual continuity within the Mansion Area neighborhood

A theme to visually unify the neighborhood is needed. Landscaping should help establish a sense of visual continuity in the area. It should include places for outdoor activities, including plazas and courtyards, as well as visual accents that give identity to individual blocks.

10. To accommodate and promote commercial land uses along Broadway, Roosevelt, and Main Street that complement and preserve the residential character of the neighborhood

An important goal for the Mansion Area is to promote a mix of uses that will support a lively neighborhood. While the predominant use will continue to be residential, compatible commercial uses should be encouraged. Uses along these streets should focus on serving the neighborhood.

B. HISTORIC PRESERVATION

The Mansion Area has experienced substantial rehabilitation in the past forty years.

Building Conditions Surveys

In December 1977, the CZDC promulgated its Zoning Regulations and initiated the activity of issuing zoning and design review permits to property owners wishing to rehabilitate or renovate their properties. Between December 1977 and late summer 1978, the Commission awarded permits for the renovation of approximately 23 residential properties. This level of activity represented only 5% of the residential structures in the Mansion Area, but the important factor was that the procedures had been established, the regulations put into place and the promise for high quality residential rehabilitation had been introduced.

In a survey of Structural Conditions conducted by the Little Rock Comprehensive Planning Department in the late summer of 1978, approximately 350 out of a total of 686 residential structures in the Mansion Area (51%) were in need of rehabilitation and renovation to return them to a structurally standard condition. Out of the 350, 115 of these structures were categorized as dilapidated, substandard or requiring major repair.

Today, those numbers are quite different. A recent mapping effort by the City of building code violations indicates that fewer than a dozen buildings in the area have been reported to be in substandard condition. This success is in part a result of the protections of the design review system.

Historic Significance Surveys

After the preparation of the initial Master Development Plan in 1977, the Quapaw Quarter Association conducted a survey of buildings for historic significance. This survey was designed to identify those structures that were significant either from a historic standpoint or for architectural design. However, in order to be listed as significant, the key character defining features had to be visible; if they were obscured with a non-historic siding material, for example, the property was not rated as significant, even though the structure itself may date from the neighborhood's historic period of significance. Because of this approach, many older buildings in the Mansion Area were rated as having no significance because they had lost their integrity as historic resources.

For those properties listed as significant (only 40%), design alterations were subject to review and proposed demolition could be delayed for 90 days. Many older buildings that did not appear historic were not subject to these provisions, and several were lost to demolition. This approach to survey ratings reflected national standards at the time. Today, however, preservationists recognize that, in many cases, buildings that are altered may be some of the best candidates for restoration. For this reason, current survey methodologies encourage considering the potential of such properties to be restored to their historic appearance.

In spite of the loss of some historic structures, the design review system administered by the CZDC has provided a sheltered climate for investment in the Mansion Area and many structures have been restored. Because rehabilitation is so prevalent, many buildings that were once rated as having no significance should now be considered historically significant.

In 1998, the CZDC commissioned a resurvey of the neighborhood to identify historic resources. All buildings in the neighborhood were to be researched, and individual property forms were to be produced, which included a description of the property, documentation of its construction history and an evaluation of significance. This survey shows a substantial increase in historically significant structures over the earlier percentage. Clearly, the Commission's oversight of their regulations has gone a long way toward preserving the historic qualities of the neighborhood. The combined tools of demolition protection and design review have served to achieve the overall objective of preserving and enhancing the neighborhood's residential character and therefore in protecting the environs of the Governor's Mansion, as the original legislation intended. (In 2001 the General Assembly expanded the Mansion Area's boundaries to the south and west. Another architectural survey, conducted in 2006-2007, was conducted by the City of Little Rock, on behalf of the CZDC, to catalogue properties in this expanded area.)

Recommendations:

1. Provide design review of alterations to all properties in the area.

The Commission should consider the effects that changes will have on the integrity of individual historic structures as well as the neighborhood at large.

2. Continue preservation initiatives.

The Commission should continue its program to identify historic properties and to provide protection to them through the review of proposals for demolition and alteration.

3. Continue to monitor building conditions.

The Commission should, in cooperation with the City of Little Rock, periodically review surveys of building conditions to evaluate the effects of its protection programs as tools for stimulating investment in older buildings in the area.

4. Clarify preservation policies through revised design standards.

In a pair of companion documents, the Commission should provide updated design standards that provide additional information to property owners about appropriate treatment of historic buildings and compatible new construction.

C. Boundary Changes

In 1975, a series of blocks lying along the northern edge of the neighborhood were not included in the boundary of the jurisdiction of the Capitol Zoning District Commission. This area is bounded by 13th Street on the south and Interstate 630 on the north; the half block west of Gaines Street is the western boundary and Cumberland is the eastern limit. This area contains a wide variety of building types and uses from single family residential to warehouse to the Mount Holly Cemetery, with a scattering of vacant sites and parking lots. Investment has not been as intense here as in the Mansion Area itself and some developments have occurred that would be considered incompatible with the revitalization trends to its southern edge.

In the blocks between the Mansion Area and I-630 a collection of eclectic buildings and uses, including new and historic, occupied and abandoned single family homes, multifamily apartment buildings, churches, a car wash, a copy center, warehouses and a recently revitalized neighborhood shopping center.

The area was zoned GB (General Business) and HR (High-density Residential) by the City of Little Rock. These designations reflect redevelopment policies of the 1970s associated with the interstate highway construction that envisioned a high density corridor developing along I-630. However, this is an important "front door" to the neighborhood as one approaches from the north, and in particular establishes the first image of entering the sphere of influence of the Governor's Mansion. (In the early 2000's, these blocks, along with much of downtown Little Rock was rezoned UU – Urban Use).

It is important that regulations in this area be applied in a manner that will assure development to be compatible with the character of the Mansion Area and that will help attract appropriate investment into the area. Therefore, it is recommended the Mansion Area boundary be extended to include these lands, which are to be zoned "N" (see the map in Section).

In 2001 the General Assembly authorized the Commission to expand the Mansion Area's boundaries to include these blocks. In 2011, the Mansion Area Advisory Committee voted to recommend the Commission expand the boundaries of the Mansion Area to the full extent authorized by the 2001 legislation.

D. Conservation Districts

In public workshops held in 1998, residents also indicated interest in expanding the boundaries of the CZDC's Mansion Area to the south, west and east to include additional residential areas. Houses here are relatively similar in character to the Mansion Area, but generally reflect a smaller scale and more modest style of building.

These areas have not enjoyed the intensive level of investment that has occurred within the Mansion Area itself. In part, this may be a result of a lack of design review and demolition protection programs. However, it is important to recognize that the Capitol Zoning District Commission has a very specific focus: To protect and enhance the environs around the Governor's Mansion. With this in mind, it is difficult to rationalize extension of the boundaries of state-administered zoning, even though the goal of promoting preservation in these outlying areas is meritorious. A more appropriate tool would be to apply comparable neighborhood protection programs through the jurisdiction of the City of Little Rock.

A variety of tools may be considered for a city program. These include the use of a zoning overlay that would employ architectural design standards and review of demolition. Similar protections also could be accomplished through a conservation district system, which is similar to a historic district designation but generally provides more flexibility in design review. State enabling legislation would be necessary to implement a conservation district program, but it would be a worthwhile effort because it could have applications elsewhere in the state as well.

At present, a planning effort for the core area neighborhoods is in the works and preliminary recommendations call for some form of design review in those outlying areas. This may provide a more comprehensive approach to addressing preservation objectives in a broader segment of these older neighborhoods within the city. The Commission should seek methods of cooperating with the City of Little Rock to encourage such approaches.

In 2001 the General Assembly expanded the Mansion Area's southern boundary from 23rd Street to Roosevelt Road, and its western boundary, south of Charles Bussey, from State to Chester. The Assembly also authorized the Commission to further expand the Mansion Area's boundaries to include additional areas to the north, east and west. In 2011, the Mansion Area Advisory Committee voted to recommend the Commission expand the boundaries of the Mansion Area to the full extent authorized by the 2001 legislation.

E. LAND USE

This subsection addresses policies for the underlying land uses permitted in the Mansion Area. Three zoning categories are applied. These include zoning for single family residential and commercial uses in a variety of design conditions.

1. Residential: Zone "M"

The land use policies underlying this zoning category are compatible with its traditional development residential patterns and with current revitalization trends. Therefore, the allowed uses of this classification should be continued.

A scattering of individual structures within the "M" zone that historically were commercial storefront buildings that provided neighborhood services. While these buildings can be adapted to residential use, and doing so should be encouraged, it may be difficult to do for some properties. For this reason, alternative commercial uses should be available as a conditional use to historic commercial buildings throughout the neighborhood in order to encourage their rehabilitation.

2. Neighborhood Residential and Commercial: Zone "N"

The Mansion Area includes a special zoning category for commercial and office uses set in a context that was traditionally residential in character. For example, both the portion of Main Street south of 19th Street and the length of Broadway are designated "N," which permits commercial uses in a development pattern similar to that of traditional single family buildings. Historically, these blocks were residential in use but have been adapting to commercial functions over time. While commercial use is the trend in these blocks, it is still important that references to the historic functions be maintained in building and landscape designs.

The land uses permitted in this area should be continued. However, the design guidelines of maintaining a residential heritage should be strengthened. In this setting, commercial uses are to be located in structures that are similar in character to historic residential lots. Front setbacks are to appear as yards, building forms should reflect residential style and commercial displays should be "low key."

New construction and redevelopment should reflect the historic features of the area and help to support the residential character of the neighborhood. New construction in this area should be designed to be compatible with this established context. Mixed use developments that include residential uses are encouraged in this zone and building forms that relate to traditional residential types should be used. Variety in building setbacks is appropriate in this area but should reflect the traditional front yard dimensions and be landscaped. Parking should be located to the side or in the rear of a lot and be screened from view.

The intersection of 23rd and Arch Streets developed historically as a neighborhood commercial center. Buildings here reflect traditional commercial storefront designs and are of historic significance. This area has also been zoned "N". Commercial uses that are compatible with the neighborhood should be considered for this area in order to stimulate revitalization of historic commercial storefront type buildings. For this reason, quiet commercial uses that are compatible with the neighborhood are to be permitted as a conditional use and where preservation of a historic resource is involved. At the same time, special use limitations are to be added to restrict uses to quiet activities that would help to serve neighborhood needs.

3. Traditional Main Street Commercial: Zone "O"

The portion of Main Street north of 19th Street that is zoned "O" was originally developed in a traditional commercial storefront context, where buildings are rectangular and aligned at the sidewalk edge. Many of these buildings survive and form the context for new development here.

In recent years, portions of Main Street in Zone "O" have lost their historic character. Original buildings were demolished and newer ones constructed that emulate building types popular in strip commercial areas. These buildings were set back from the sidewalk edge, with parking lots in front. This development eroded the traditional character of the sidewalk and diminished the sense of visual continuity. These properties do not represent a part of the context that should be repeated in new development.

A few infill buildings have been built in the past 5 years that are out of scale with the residential character of the neighborhood. Some, for example, are set back from the street with parking in front.

This area should continue to develop as a concentration of commercial uses. Development along Main Street in Zone "O" should reinforce the traditional storefront commercial character of the area. Traditionally, this portion of Main Street was animated with commercial activity. Storefronts provided views to goods and services inside ground floor shops, and the sidewalk was active with pedestrians. While variety existed in building designs, there was a general sense of continuity and interesting details established a human scale that invited pedestrian activity.

This commercial activity center attracted pedestrians from nearby neighborhoods, a goal that exists for today. This distinctly different setting should be maintained as a typical Main Street character.

New buildings should respect this established character but should not literally imitate historic building styles. Historically, buildings created a strong edge to the street because they aligned at the front lot line and were usually built the full width of the parcel, to the side lot lines. Patterns were created along the street by the repetition of similarly-sized building elements. For example, uniform facade widths evenly spaced along Main Street create a rhythm that contributes to the visual continuity of the area. At a smaller scale, the repetition of upper story windows across most building fronts also creates a unifying effect. These patterns should be respected in all new construction and redevelopment projects.

Presently, restaurants are permitted by right. At the same time it is important that regulations remain in place that prevent establishments that are incompatible with the neighborhood.



That portion of Main Street north of 19th Street, zoned "O," originally developed in a traditional commercial storefront context, where buildings are rectangular and aligned at the sidewalk edge.



New buildings should respect the established character.



Uniform facade widths evenly spaced along Main Street create a rhythm that contributes to the visual continuity of the area.

F. STREETSCAPE DESIGN

1. Pedestrian Systems

The Mansion Area developed in a period in which walking was a major mode of circulation and street cars provided public transportation. In the early twentieth century, automobiles came on the scene but, even so, remained "in balance" with other modes. Today, the car dominates the scene. Nonetheless, an important goal is to renew the balance of circulation systems. In order to do so, enhancements to pedestrian circulation systems should be considered, and automobile circulation should be planned such that any potentially negative effects upon the neighborhood will be minimized.

a. Sidewalk Repairs

In general, pedestrian systems in the neighborhood consist of a network of sidewalks that flanks all of the streets. These provide a comfortable means of circulation, except that several segments are badly deteriorated. In these cases, broken pavement discourages walking. New sidewalks should be installed in such conditions.

b. Crosswalk Improvements

In addition, crossing some major arterials may be intimidating. Providing enhanced crosswalk designs, which may include delineating the crosswalk with special paving and installing special signs and lighting, should be considered. Prime locations are along Broadway and Main Street.

c. Recommendation: Continue to encourage the City of Little Rock's support and infrastructure investment in the Mansion Area

The Commission should work with the City to develop a long-range plan for upgrading the infrastructure in the Mansion Area.

2. Public Transit Service

Three Central Arkansas Transit Authority routes provide service to the Mansion Area along Main Street. Another route runs down Broadway and a cross-town route provides service along 17th. These services should be continued and enhanced. Installing bus shelters along Main Street that would be convenient for use by neighborhood residents should be considered, for example.

a. Recommendation: Encourage neighborhood residents to continue and increase their use of public transportation.

Increased ridership in the Mansion Area can also bring increased investment from the City and CATA. The Commission should continue to foster this relationship and strongly encourage the neighborhood residents to do the same.



Crossing some major arterials may be intimidating. Providing enhanced crosswalk designs, which may include delineating the crosswalk with special paving and installing special signs and lighting, should be considered.

3. Automobile Circulation

The Mansion Area is linked with downtown Little Rock by Broadway, which is classified as a "Principal Arterial," and by Main Street, which is a "Minor Arterial." 14th and 17th Streets provide the primary east-west routes through the neighborhood and are designated "collectors." The intersections of these major east-west and north south streets are therefore important ones, where motorists make decisions about turning movements. These are also the key points at which visitors turn to approach the front gates of the Governor's Mansion. Center Street runs one-way northbound above 14th Street, thereby significantly reducing the level of southbound traffic on it in the Mansion Area.

a. Recommendation: Traffic impacts on the neighborhood should be minimized to the greatest extent possible.

In general, automobile circulation systems work efficiently in the neighborhood. However, while Main and Broadway do serve as arterials for the city, their traffic impacts on the neighborhood should be minimized. Because of the potential for higher traffic volumes and rates of speed, one-way streets should be discouraged due to their impacts upon pedestrian friendly environments. Other techniques which contribute to traffic calming, such as on-street parking, should also be considered.

4. Parking

While the use of automobiles has certainly increased over the years, on-street parking supply generally remains adequate, and the existing parking requirements for on-site design also are sufficient. In residential areas, the historic treatment of parking was to locate vehicles to the side or rear of a property. In many cases, a garage or carriage house served to enclose cars and screen them from view. However, parking design is a concern along the commercial corridors. In these cases, the visual appearance of parked cars is a major concern since the potential for larger parking lots, which can negatively affect the visual character of the area, exists here.

a. Recommendations:

i. Encourage area residents to develop off-street parking when undertaking rehabilitation or new construction projects.

This concept is reinforced in the Mansion Area Design Standards, and compliance should be strongly encouraged.

ii. Zoning standards that require locating parking away from the street edge should be enforced, and design standards that promote the screening of cars from the public way should be rigorously applied.

G. PUBLIC SPACES

In the Mansion Area, streets and sidewalks form the bulk of the public spaces. Sidewalk designs generally consist of concrete paving, frequently separated from the curb with a planting strip. In addition, a variety of parks and open spaces exist. Mount Holly Cemetery defines the northwest corner of the neighborhood with a green space and provides passive open space opportunities for the neighborhood. Formal public parks lie just north of the interstate highway.

Because the bulk of the public spaces are in the right of way, they are under the jurisdiction of the City of Little Rock. Therefore, most streetscape improvements occur through special assessment programs established by business or property owners. In this case, the Commission's role is a supportive one, in which it should cooperate with city agencies to encourage improvement programs that would enhance the streetscape.

1. The Streetscape

The streetscape design should help to establish a unified image for the Mansion Area. In residential areas, the streetscape design consists of paved detached sidewalks and planting strips. Streetscape designs in commercial areas should include street trees, furniture such as benches and waste receptacles, and construction of planting areas, all coordinated to establish a distinct identity for the area.

Historic development patterns seen in street and alley plans often contribute to the distinct character of the Mansion Area and, therefore, should be preserved. These street plans influence the manner in which primary structures are sited, and they also shape the manner in which secondary structures and landscape features may occur on the site.

The Mansion Area's streetscape design should serve to reflect the characteristics of the neighborhood, establishing a sense of visual continuity throughout. Elements to be considered include: A consistent public landscape palette, distinctive gateway designs, consistent architectural design and special public improvements. The Framework Map for the Mansion Area (Section 6-301) identifies the streetscape design concept, which includes four categories of treatment:

a. Traditional Main Street Corridor Streetscape (Main Street between I-630 and 19th Street)

Within this portion of Main Street, small scale commercial buildings are to be the dominant use. Building fronts generally should be located at the inside edge of the sidewalk. The streetscape should convey an urban character with street trees, decorative street lights, benches and planters. In 1989-1991, property owners established the South Main Street Improvement District and joined in a streetscape improvement program that included installation of many of these features. This design palette should be continued farther south.

b. Residential Commercial Corridor Streetscape (Main Street south of 19th Street and Broadway between I-630 and West 24th Street)

This category applies to those streets that are residential in character but accommodate both commercial and residential uses at a lower density. A front yard serves as a transitional space between the public sidewalk and the private building entry. In many blocks, front yards are similar in depth, resulting in a relatively uniform alignment of building fronts which contributes to the sense of visual continuity. Maintaining the established range of setbacks is therefore preferred. Development along these streets should reflect the existing residential character and be set back from the street according to the historic pattern, with landscaped front yards and canopy street trees evenly spaced in the "tree lawn."

c. Center Street

Center Street should serve as the ceremonial entry to the Governor's Mansion and be more pedestrian in character. The streetscape treatment should include canopy street trees and low-intensity, decorative street lights. The Commission should seek opportunities to enhance the street in cooperation with the City of Little Rock.

d. 17th Street

This east-west street, just north of the Governor's Mansion grounds, provides access from Broadway and Main Street to Center Street, which then feeds directly south into the Governor's Mansion. The streetscape treatment here should include evenly spaced canopy street trees, decorative street lights and specially designed signs.

e. Recommendation: Develop streetscape designs that invite pedestrian activity.

Buildings that relate to their immediate context and streetscapes with street trees, lights, furniture and directional signs all encourage pedestrians to make use of the area and feel safe.

2. Neighborhood Gateways

Key entry points, or "gateways," exist along major streets into the neighborhood. These are points at which motorists may first become aware that they are entering this historic area. To the north, gateways occur at the intersections of the interstate frontage road with Broadway and Main Street.

The experiences at these key gateways are quite different: At Broadway, the tone of the neighborhood is clear. Restored homes and mature landscaping signal a special district. By contrast, the context for the Main Street gateway is a mixed collection of commercial structures. Some retain their historic character, while others are more recent and reflect an auto-oriented culture.

Similarly, gateways exist at the southern boundary of the neighborhood at 23rd and Broadway and 23rd and Main. In each case, it is desirable that the boundary of the neighborhood be identified. This would be particularly valuable along Main Street, where the residential character of the neighborhood is not evident.

a. Recommendation: Develop visual "entry" elements at key intersections around the Mansion Area.

The Commission should seek opportunities to cooperate with the City of Little Rock to enhance the impact of these gateways with landscape improvements.

3. Key Intersections

In addition to the gateway conditions, other key intersections exist where motorists make important turning movement decisions. Two of these key intersections, or "nodes," exist at the intersections along 17th Street at Broadway and Main Streets, where motorists turn to access the Governor's Mansion. At present, however, these are not clearly identified. Conventional metal road signs are positioned at these points, indicating the location of the "Mansion." These nodes should be designed to help identify the location of the "Governor's Mansion."

Gateways into the Mansion Area should be designed with motorists, bicyclists and pedestrians in mind. Some elements, such as flowering ornamental trees or public art, should be large enough in scale to be perceived at a distance by drivers. Information signs should be provided that can be read and easily identified by a motorist or bicyclist who is slowed or stopped at an intersection. Fine-grain detail should be introduced for viewing by pedestrians and by motorists in stopped cars. Examples include; low shrubs, ground covers, and perennial and annual flower beds.

The gateway concepts discussed above also should be incorporated at the intersections along 17th Street at Broadway and Main Streets, providing a ceremonial gateway to the Governor's Mansion. The gateway should include a small corner plaza with well designed signs and colorful landscaping.

a. Interpretive plaza

Another key intersection is located at the north end of Center Street between West 12th Street and I-630, a point at which one can view both the Governor's Mansion and the Old State House. This is not a key intersection from the standpoint of traffic volumes, but it offers a special opportunity for interpreting the history of the area. Because the site provides views to the Governor's Mansion and the Old State House, as well as the rest of downtown Little Rock and the Capitol Area of the CZD, it is in a unique position to serve as an interpretive site where markers could provide information about these historic sites. It would also serve as a northern anchor to the Center Street corridor, with the Governor's Mansion serving as the southern terminus.

b. Recommendations:

i. Develop visual "way-finding" elements at intersections throughout the Mansion Area.

When in the Mansion Area, visitors should always have a sense of direction and know where important features, like the Mansion, are. These elements should be large enough to be seen at a distance but also should incorporate fine details that create interest to pedestrians and bicyclists. The use of colorful landscaping is encouraged.

ii. Develop an interpretive site for the Governor's Mansion and the Old State House.

A site at the northern end of Center Street in the Mansion Area should be considered. The Commission should explore cooperative opportunities with the City and other state agencies to accomplish this objective.

4. I-630 Open Space

As part of the I-630 construction project in the 1980s, open space areas adjacent to the freeway were identified to be improved in a manner compatible with the character of the Mansion Area. Some areas currently owned by Arkansas Highway and Transportation Department may remain available, but administrative obstacles may make improvement difficult, although not impossible. These lands remain an opportunity to create a positive image for the neighborhood as seen from the freeway. The interpretive plaza recommended at the north end of Center Street in the Mansion Area is an example.

a. Recommendation: The Commission should continue to work with the City of Little Rock and Arkansas Highway and Transportation Department to acquire and improve open spaces along the interstate.

5. Public Art

Opportunities to place public art exist in some of the more active areas of the neighborhood, especially at key intersections along the commercial corridors. Art installations can provide a distinct image, promote regional identity, and enhance the neighborhood for residents and visitors. Public art may include individual art objects that are installed at key intersections, along sidewalks and in association with other special public facilities. Other art installations may include decorative painting, murals and modifications to the street furniture along commercial corridors that provide surprise and delight in the urban setting.

a. Recommendation: The Commission should consider an opportunity to install public art as a part of the proposed interpretive park at the north edge of the neighborhood.

The Commission also should work with the City of Little Rock to explore opportunities for installing public art at key intersections on Main and Broadway. Private developments in these areas also should be strongly encouraged to incorporate public art in their improvements.

THIS PAGE INTENTIONALLY LEFT BLANK.

SECTION 6-301 MANSION AREA FRAMEWORK MAP

This map shows the locations of many of the recommendations described in this article. (NOTE: This map represents the Mansion Area's boundaries as they existed in 1998.)

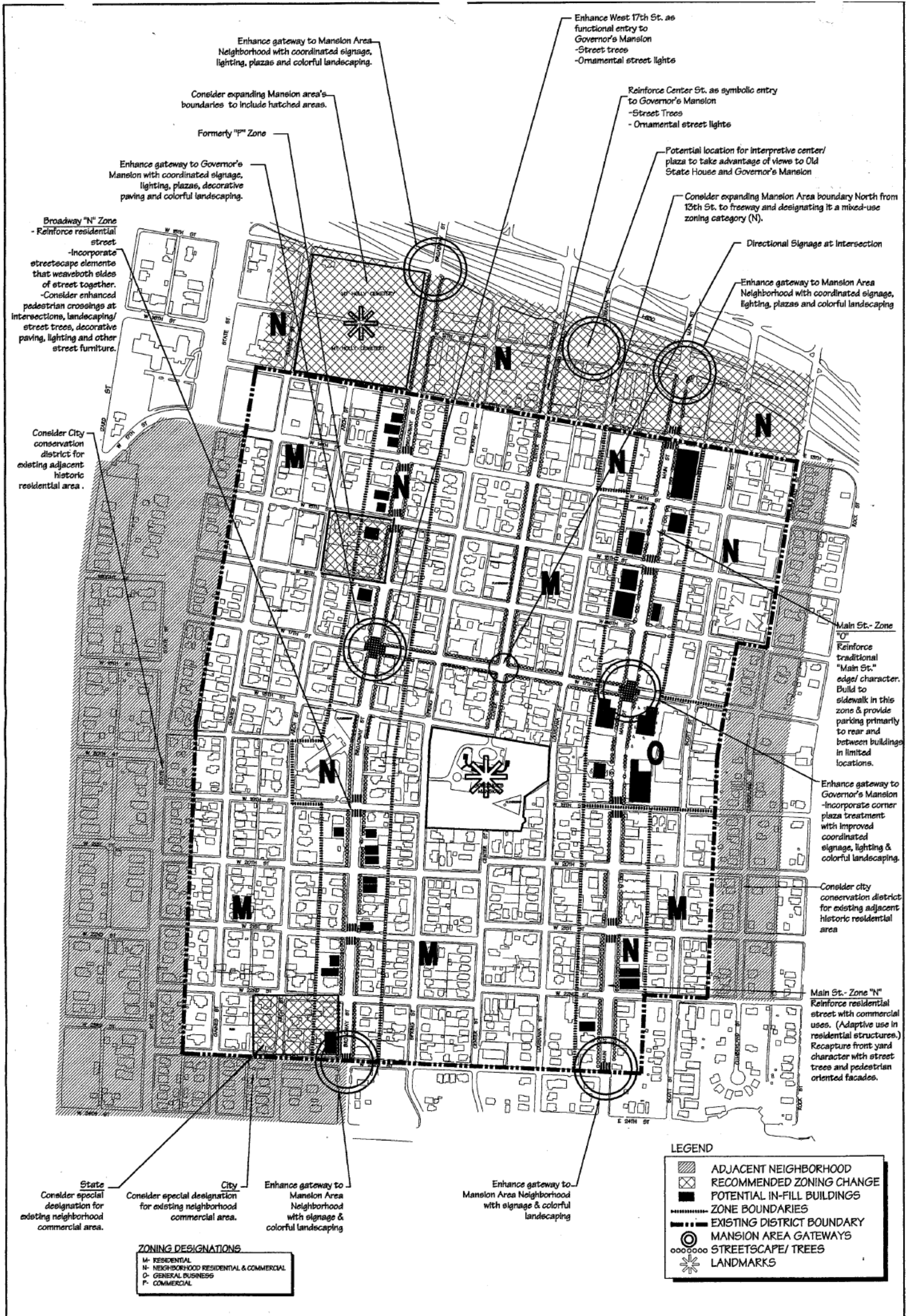

JAMESON
ARCHITECTS P.A.
SUITE 205
2701 KAVANAUGH BOULEVARD
LITTLE ROCK, ARKANSAS 72205
501 666-6600 - FAX 666-5177

CONSULTANTS
Winter & Company
Planning and Development Consultants
MEMPHIS, TENNESSEE

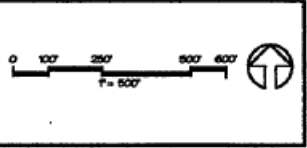

MANSION AREA FRAMEWORK MAP

ORDINANCE PROJECT
CAPITOL ZONING DISTRICT
CAPITOL ZONING DISTRICT COMMISSION
LITTLE ROCK, ARKANSAS

DATE: 12/18/2018
JOB NO.: 02-10
FILE: 02PZ01
REVISIONS:

DRAWING NO.
M-2

THIS PAGE INTENTIONALLY LEFT BLANK.

ARTICLE SEVEN

CAPITOL AREA DESIGN STANDARDS

SECTION 7-101 INTRODUCTION

The following article applies to new construction in the State Capitol Area of the Capitol Zoning District, as well as to work performed on non-historic existing structures and site features. The Standards for Parking Lot Design and landscaping (Sections 7-203 and 7-204) may also be applicable to large parking areas in the Mansion Area.

A. Overall design goals for the Capitol Area

1. Establish a distinct identity for the neighborhood that will continue to serve as a foreground for the Capitol and also enhance it. This means that key view corridors to the building should be defined and preserved. At the same time, other buildings in the area should establish a sense of relating to the Capitol without imitating it architecturally. Certain common way of building should be followed to create a building typology that will contribute to a visual cohesiveness in the neighborhood while also accommodating variety in designs and a mix of uses.
2. Streets should once again be places that are active with pedestrians, where walking is a pleasant experience. The automobile should appear subordinate to other uses and therefore parking and circulation requirements should be accommodated in a manner that supports the desired uses for the neighborhood.
3. Landscaping should help establish a sense of visual continuity in the area. It should include places for outdoor activities, including plazas and courtyards, as well as visual accents that give identity to individual blocks. This should include public art and other unique urban design features.
4. Signs also should be subordinate to the overall neighborhood character. While it clearly is important to identify businesses and signs will continue to be a part of the scene, they should complement building designs, not detract from them and their placement and design should help to convey a sense of order for the area.
5. Within the overall neighborhood, the tradition of establishing subareas with distinct identities should be continued. For example, where historic residential buildings survive in sets, that character should be preserved. Similarly, the distinct character of the neighborhood around Union Station should continue to be reinforced. Most important, Capitol Avenue should develop as the ceremonial approach to the Capitol.

B. CAPITOL AREA NEIGHBORHOODS

The Capitol Area Master Plan recognizes a series of neighborhoods, which should each develop with their own individual identities. These distinct characteristics of individual neighborhoods should be reinforced:

1. State Capitol Foreground (Zone "A")

Capitol Avenue links downtown Little Rock with the State Capitol. It should have the highest density of development in the Capitol Area, with the focus at the western end near the base of the Capitol building itself. Along Capitol Avenue, buildings should frame views to the Capitol and define the edge of the street to provide an attractive pedestrian zone. Medium-scale office buildings with ground floor storefront activities should define the street edge. Parking should be located in the rear. A goal is to have a mix of governmental offices and private professional offices as the dominant uses. These should be supplemented with service businesses, dining and retail.

The rest of this zone should continue to develop as a concentration of governmental offices, and commercial uses, including professional offices and support businesses. Medium scale office structures should be the predominant building types. It is similar in character to Capitol Avenue itself, although initially it may develop at a somewhat lower density. Defining views from major roadways, including Interstate 630, to the Capitol should be special considerations here and pedestrian connections to Capitol Avenue and to the State Capitol should be enhanced. Landscaping of parking lots will be particularly important for this reason.

2. Capitol Area Residential (Zone "B")

These areas retain the greatest number of historic residential buildings, several still in rows that convey the early character of the neighborhood. These should be retained and new construction in this area should be designed to be compatible with this established context. Mixed use developments that include residential uses should be encouraged in this neighborhood and building forms that relate to traditional residential types should be used. Variety in building setbacks is appropriate in this area. Where buildings are set back, the foreground should be landscaped to reflect the tradition of front yards. Parking should be located to the side or in the rear of a lot and screened from view.

3. Union Station Neighborhood (Zone "C")

The land around the Union Station depot should develop with a mix of uses that supports the adaptive reuse of the station itself. A mix of residential, offices, dining and retail should be encouraged. This also should help to serve as a western anchor to specialty retail activities that are emerging along Markham Street. A variety of building types and setbacks is appropriate. Medium density housing should be encouraged to develop in conjunction with commercial uses. It is vitally important that a pleasant pedestrian experience develop here, one that invites "exploration" of the neighborhood. Historic buildings in the area should be preserved and new buildings near them should be compatible in character. New development also should make creative use of the sloping topography here. Stepped terracing of sites, for example, should be considered.

4. Interstate Industrial (Zone "D")

This small zone is located at the southwest corner of the Capitol Area, below the Interstate at the lower end of the Capitol campus. Motorists approaching downtown from the west look across these lands to the Capitol dome. It is zoned for industrial uses, in part because it is relatively remote and access is limited. While it is not a key area in terms of planning for the character of the foreground of the Capitol, it is important that its development within this area be managed such that it does not impede views to the Capitol.

C. CAPITOL AREA STREET CORRIDORS

The Capitol Area Master Plan also describes several types of street corridors. In addition to the overall design goals for the Capitol Area and the character of each neighborhood zone, proposal for new development should also consider the character of the street on which they are located.

1. Commercial Corridors

Streets the "A" Zone are those in which commercial buildings are to be the dominant use and establishing a building line at the sidewalk edge is a goal. Building fronts therefore should be located at the inside edge of the sidewalk. These are located along Capitol Avenue and streets to the south of it.

2. Victory Street Corridor

Victory Street is designated in the Master Plan as a corridor that should link Capitol Avenue with the Union Station area. It should be inviting to pedestrians and convey an "urban" character. Primary uses along the street should be commercial, including professional offices and service businesses as well as retail and dining. Buildings should be located at the sidewalk edge to establish an inviting pedestrian experience. Parking should be located in the rear.

3. Medium Density Mixed Use Corridors

Streets in the Medium Density Mixed Use Corridors are those in which a mix of commercial and residential uses are anticipated at a moderately high density. Defining the street edge with buildings is also a goal in these areas, although some variety in setbacks may occur where residential uses are at street level. The majority of buildings within a block therefore should be built with their fronts at the inside sidewalk edge. These are generally located to the north of Capitol and around Union Station.

4. Low Density Mixed Use Corridors

Streets in the Low Density Mixed Use Corridors are ones where development should blend with established residential scale structures. A mix of uses is anticipated in a setting in which the character of traditional front yards is promoted. Buildings may be set back from the street with landscaping in the foreground. These are generally located in the remaining residential areas.

The Standards in the following sections are preceded by "C," to indicate they are Design Standards for the Capitol Area.

SECTION 7-201 SITE DESIGN STANDARDS

Each site should be developed to help define active spaces for people, to provide pedestrian connections between sites, and to define street edges. The placement of a building on a site should therefore be considered within the context of the block and how the structure will reinforce the broader design goals for the neighborhood.

Alignment of Building Fronts

C1. A building should be oriented to reflect the street grid.

- In general, the front of a building should be parallel with the street.
- An exception exists at the intersection of Capitol and Woodlane Avenues, where two different street grids intersect. This variation may be reflected in building alignments.

C2. In commercial corridors, locate a building front at the sidewalk edge.

- A building in Zone A shall have a zero setback for a minimum of 75% of its facade along the sidewalk edge. Exceptions may be granted only by the CZDC for those conditions where the predominant character of adjacent properties reflects a setback from the sidewalk. In those conditions, the setback from the sidewalk cannot exceed 25'.
- If a portion of the building wall is to be set back from the sidewalk such as to create a courtyard or arcade, continue to define the sidewalk line with planters, columns, railings or similar features.

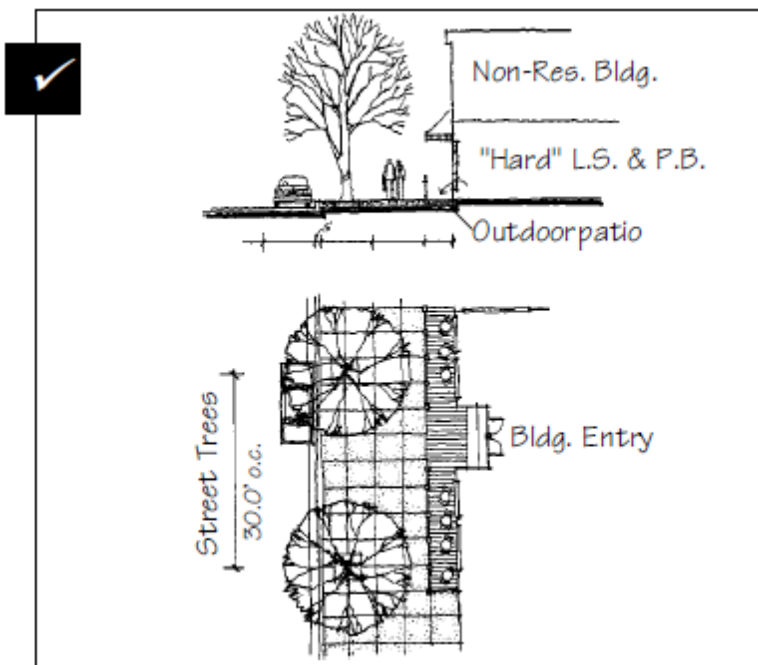

Buildings should be located at the sidewalk edge.

C3. In medium-density mixed use corridors, locating a building front at the sidewalk edge is encouraged.

- A building with a commercial use at the street level should have a minimum of 50% of its facade at the sidewalk edge. If a portion of the building wall is to be set back from the sidewalk such as to create a courtyard or arcade, continue to define the sidewalk line with planters, columns, railings or similar features.
- A building with a residential use at the street level may be set back a maximum of 25 feet from the sidewalk edge. The front setback area should be landscaped.
- Access to parking facilities should be provided from an alley when feasible. (See the standards for parking.)

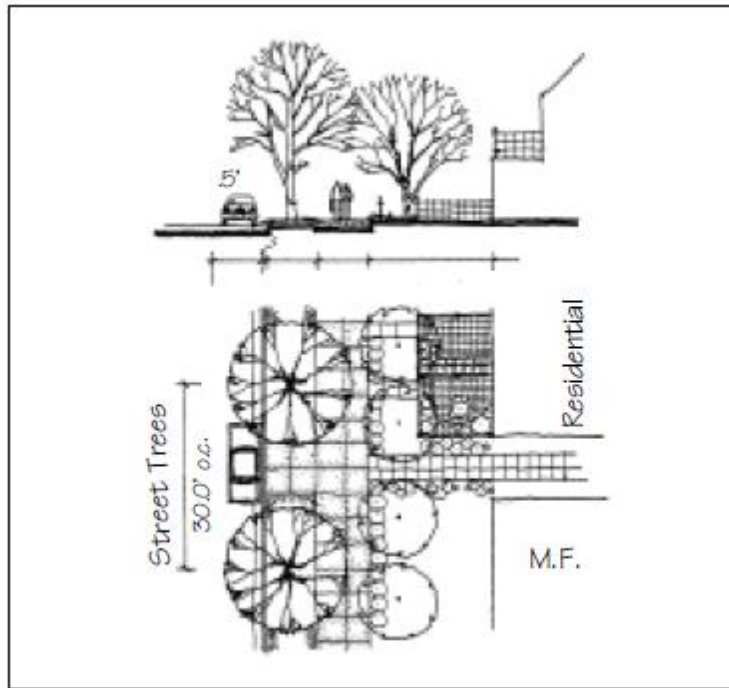

A few exceptions may be granted where a building may be setback from the sidewalk edge.

C4. In low density corridors, maintain the character of residential yards along the street.

- Variety in building setbacks is appropriate.
- A building may be set back a maximum of 25 feet from the sidewalk edge. The front setback area should be landscaped.
- Access to parking facilities should be provided from an alley when feasible. (See the standards for parking.)

View Corridors

A key consideration in the Capitol Area is planning to maintain special views. The primary view objective is to provide dramatic views to the Capitol Building from key points in all directions. In most cases, this can be achieved by keeping an open view shed throughout the area. Keeping the height of buildings below that of the main level of the Capitol Building is the established policy for doing so. In some cases, however, it is more desirable to frame the view by enclosing a view corridor with buildings, and then providing points at which the view may open out to reveal the Capitol. This is the concept for framing views along Capitol Avenue.

In addition to view consideration *to* the Capitol, it is also desirable to establish selected view corridors *from* the Capitol to other features. For example, providing a view corridor from the northern Capitol circle to the bottom lands to the north should be an objective. Views to other landmarks also should be considered. Creating a view corridor to Union Station, for example, is desirable.



Maintain views to the Capitol from major streets and public spaces.

C5. Plan view corridors as a series of vista experiences.

- In many cases, building fronts should align along street edges to frame views, and then provide outdoor areas, such as plazas, to "open up" the view. This will create variety in the view experience.
- In other situations, buildings should be set back from the front property line to provide uninterrupted views.
- Also consider the height of buildings. Building heights should generally remain low. See the Capitol Area Master Plan.

C6. Maintain views to the Capitol from major streets and public spaces.

- Major Streets include Capitol Avenue, Interstate 630, Cantrell Road and Markham Street.
- View corridors from Union Station to the Capitol are also important.

C7. Provide views from outdoor plazas and courtyards to the Capitol when feasible.

- This is particularly important along Capitol Avenue.

C8. Provide views from outdoor plazas and courtyards to area landmarks when feasible.

- Provide views to Union Station, for example.

Plazas and courtyards

The development of plazas and courtyards should be encouraged in order to enhance the street scene as a place for pedestrians. These should be easily accessible and comfortable to use for substantial parts of the year.

C9. Orient open space to views of activities, architectural landmarks or natural land forms that are visually interesting.

- View corridors to the Capitol and Union Station are particularly appropriate locations.

C10. Provide outdoor seating that is usable year-round.

- Use designs that will drain water and that will not collect debris.
- Position seating so it can be buffered from extreme winds.
- Provide for shade in hot months and for sun in winter months. Shading devices may be integrated elements of the architecture, or they may be moveable features such as awnings or umbrellas.

C11. Connect open spaces to major building activities.

- Consider connections to restaurants or outdoor dining areas and to shop or office entrances, especially where the space can be used for product display.

C12. Where feasible, create a sense of enclosure for outdoor seating areas.

- Use buildings, planters, low walls or railings to define and enclose seating areas.

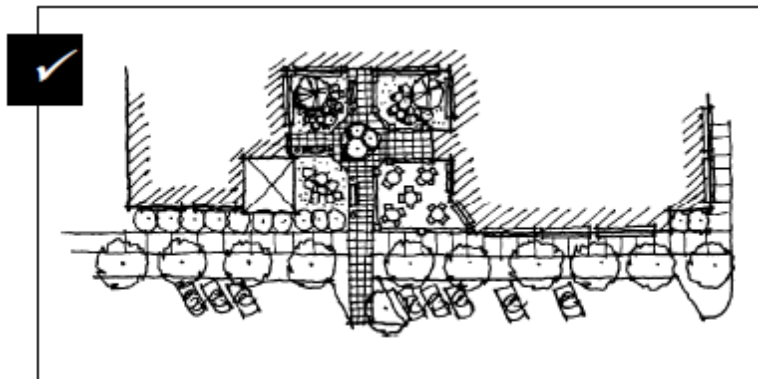

Use buildings, planters, low walls or railings to define and enclose seating areas.

Drop-Off Areas

Passenger drop-off areas should be considered and should be designed to provide safe, convenient use. This applies particularly to higher density developments along Capitol Avenue, where parking lots and structures are to be located to the rear of buildings.

C13. Clearly distinguish drop-off areas from service lanes.

- Provide a separation between a driveway curb cut and a drop-off area to minimize circulation conflicts.
- Provide a clear separation of vehicular traffic between drop-off zones and access to either a parking lot or parking structure.
- Use a textured paving material that is distinguishable from the travel lane at the drop-off.
- Consider using signs to indicate “drop-off zone” or “passenger loading only”.

Pedestrian Connections Through Parking Lots

Walkways that lead pedestrians from parking to building entrances should be planned such that they minimize crossing conflicts with cars and facilitate easy movement. The pedestrian should feel comfortable and in a clearly defined “territory.” This should include a variety of grade separations or other vertical features, such as bollards, lights and trees, which distinguish the pedestrian way from the drive lanes and parking stalls. Also, clearly defined entry ways should be included.

C14. Provide clear, convenient pedestrian routes through parking lots to building entrances.

- Pedestrians should not be required to cross service drives or areas to gain access to major entrances from principal parking lots.
- Where major pedestrian routes within the parking lot will cross roadways and drives, use textures or colored paving that is distinguishable from the road surface to define these pedestrian routes.

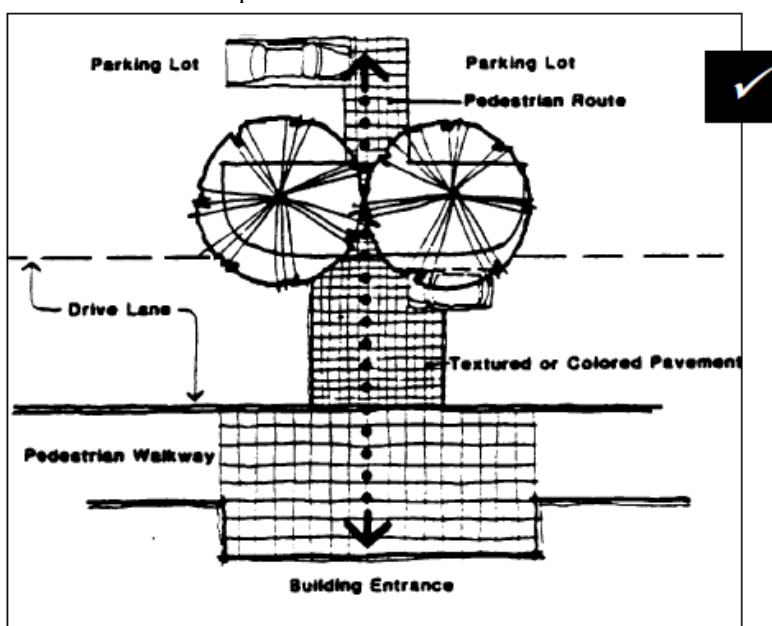

Provide clear, convenient pedestrian routes through parking lots to building entrances.

Service Entrances and Loading Areas

Service areas should be visually unobtrusive and should be integrated with the design for the site and the building.

C15. Orient service entrances, waste disposal areas and other similar uses toward service lanes and away from major streets.

- Coordinate the location of service areas with adjacent developments, so that shared service drives may be feasible.
- Avoid placing service areas where they will be visible from adjacent buildings or where they will impact designated view corridors.

C16. Screen service entrances with walls or landscaping.

Pedestrian Interest at the Street Level

The development of the first floor street level as an area that is interesting to the pedestrian is a primary objective throughout the Capitol Area.

C17. Develop the street level of a building to provide visual interest to pedestrians.

- For buildings located on Capitol Avenue, a minimum of 65% of the linear dimension of the first floor street wall should contain display windows.
- For buildings located on other streets a minimum of 55% of the first floor street wall should contain the following: display windows or outdoor dining places, wall murals or sculpture. Other alternatives include display cases or decorative architectural screens and plant materials.

C18. Provide direct access from a public sidewalk to retail shops.

- Avoid designs that require patrons to enter the internal lobby of a building in order to enter a shop.

C19. Shelter the sidewalk along the street level.

- Use awnings or consider arcades with storefront glass recessed.



Use awnings to shelter the pedestrian.

SECTION 7-202 ARCHITECTURAL DESIGN STANDARDS

Building Scale

Buildings should appear to have a “pedestrian scale.” In general, this is the result of the use of familiar forms and elements that can be interpreted in human dimensions.

C20. Express facade components in ways that will help to establish building scale.

- Compositions that emphasize floor lines or that express rhythms and patterns of windows, columns, and other architectural features are encouraged.

C21. When feasible, align facade elements with others in the block.

- Where feasible, reinforce the general alignment of building heights.
- Express the position of each floor with horizontal elements.
- When feasible, align first floor window heights with others in the block.

Exterior Expression of Floors

The exterior wall design should help pedestrians establish a sense of scale with relation to each building. In the interest of the CZDC's goal of creating a campus-like environment, efforts should be made to prevent the larger buildings from dwarfing the pedestrian. Articulating the number of floors in a building can help to establish a building's scale, for example.

C22. Express the position of each floor in the external skin design of a building.

- Use belt courses or other horizontal trim bands, of contrasting color and materials to define floor lines.
- Also consider articulating structural elements, or changing materials as methods of defining floors.

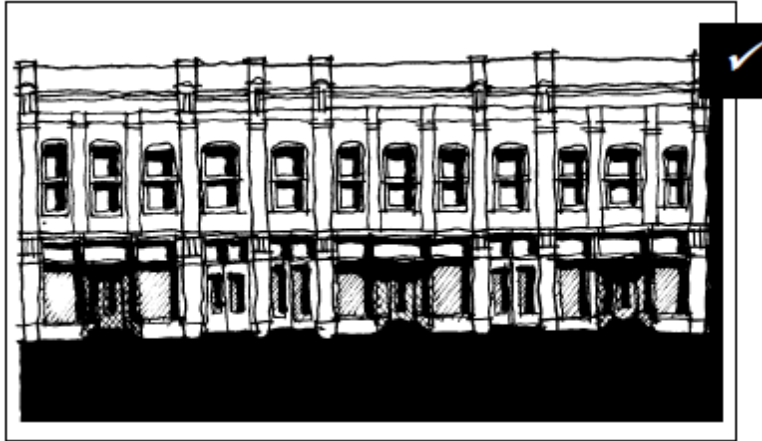

Use belt courses or other horizontal trim bands, of contrasting color and materials to define floor lines.

Horizontal alignment of facade components

Horizontal alignment of architectural features can occur among building fronts in the form of cornices, window sills, and moldings. These lines can enhance the visual continuity of the street, which is to be encouraged.

C23. Align facade elements with others in the block.

- This is particularly relevant along commercial corridors.
- Facades should be articulated to repeat the standard heights of building components, such as floor levels and cornices.

Distinction Between Upper and Lower Floors

Typically, the first floor of commercial buildings is predominantly transparent with a large proportion of void to solid. This distinction helps to define the first floor as more open to the public in general. The line established by uniform storefront heights also helps to establish a sense of scale for pedestrians.

C24. Express the distinction between upper and lower floors in commercial buildings.

- Develop the first floor as primarily transparent.
- On upper floors, consider using windows or other architectural features that will reinforce the typical rhythm of upper story windows found on traditional commercial buildings.

Building Height

A primary concern is that a new building or major additions to an existing building be designed to maintain views of the Capitol building and dome. This particularly includes considerations of placement and also height of any new construction. Allowable building height is limited to 45 feet with a maximum of three stories in the Capitol Zoning District. Upon a Height Review and subsequent approval by the CZDC, additional height of up to 30 feet, but under no circumstances exceeding 75 feet total with a maximum of five stories, can be allowed. The definitions for allowable height and allowances for additional height are included in the General Standards. The criteria by which the CZDC will review a proposal for conformance with these standards follow.

C25. In general, buildings may be no more than 45 feet or three stories in height.

A building fronting Capitol Avenue in Zone A or located in Zone C may exceed this limit if the following conditions are met:

- In Zone C, if the property slopes greater than 10% and no more than five stories are above grade at either end of the site.
- The building will appear compatible height with other buildings in the block.
- Residential uses will be incorporated into any additional height which exceeds the allowable limits within Union Station Neighborhood, Zone C.
- For a building fronting Capitol Avenue, the portion of the façade exceeding three stories or 45 feet must be set back from the Capitol Avenue right-of-way by at least 50 feet.
- Standards for views listed below are met.

C26. A building should appear compatible in height with established buildings in the block.

- If a structure would be markedly taller than adjacent buildings, step down the height to establish a transition in scale with the adjacent structure.

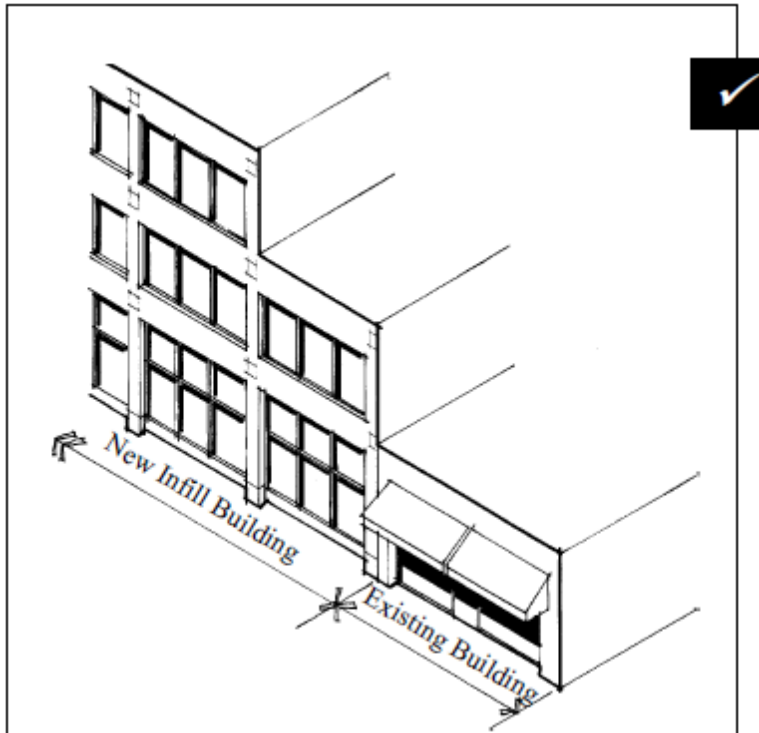

If a structure would be markedly taller than adjacent buildings, step down the height to establish a transition in scale with the adjacent structure.

C27. Although a general similarity in building heights at the sidewalk is encouraged, variety in building form is desirable in large building projects.

- For large projects that occupy several lots, variation of building height within the project is encouraged.
- For smaller projects, consider variation of the overall height in relation to its neighbor.

C28. The placement of any new building or significant addition to an existing building should be evaluated for any potential impacts upon existing views.

Careful consideration regarding the placement of new buildings and major additions to existing buildings should be given particularly upon their impacts to existing views. Three types of views should be considered:

- View Corridors; such as those along Capitol Avenue, should be maintained and frame views as possible.
- Panoramic Views; views from areas such as the I-630 corridor and the western approach from W. 3rd St. should be maintained.
- Vistas; from areas such as the Capitol steps, should be maintained.

Building Materials

Although variety in building styles is anticipated, visual continuity among major building materials is desired throughout the Capitol Area. Materials should be similar in appearance to those that are prevalent on the Capitol campus and with those that were seen historically in the neighborhood. Materials that convey a regional identity are particularly encouraged. Alternative materials that achieve a similar appearance may be considered.

C29. The primary building material should be masonry.

- Brick, stone and concrete are appropriate.
- Stucco should only be used as a secondary material.

C30. Reserve strongly contrasting materials and colors for accents, such as building entrances.

- Avoid the excessive use of many different façade materials.

C31. Avoid using highly reflective surfaces that will generate glare, especially at the pedestrian level.

- Limit reflective glass to an outside daylight reflective factor of 30% or less. Mirror glass is not allowed except in very limited applications.
- When allowed, limit reflective glass to no more than 15 % of the total surface area of the building.

Scale of Building Materials

Perceiving the scale of the building is important in terms of the pedestrian's ability to relate comfortably to buildings, and to relate to walking distances between buildings, amenities, and parking lots. Building materials that are manufactured in units measurable in human proportions should be used because they help people to interpret the size of a building. Brick, tile, and stone are examples.

C32. Use building materials that are similar in their dimensions and that can be repeated in traditional modules.

- This helps to establish a sense of scale.
- Brick and stone are preferred.
- Cast or scored concrete that conveys a sense of proportion similar in scale to traditional materials also may be appropriate.
- Expanses of large featureless surfaces are inappropriate.
- In general, large metal, glass or plastic panels or other non-modular materials used in curtain wall construction are inappropriate unless other architectural features can adequately provide a sense of scale.

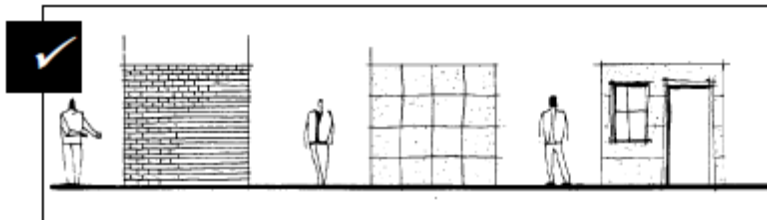

Use building materials that are similar in their dimensions and that can be repeated in traditional modules.

Use of Traditional Facade Components

The repetition of traditional facade components creates patterns and alignments that visually link buildings within a block, while allowing individual identity of each building. These elements are familiar to the pedestrian and help establish a sense of scale. The use of traditional facade components is therefore encouraged, with the understanding that these elements may be reinterpreted in a variety of creative ways.

C33. Consider incorporating traditional facade components in new designs.

- Consider the following elements:
 - Parapet cap or cornice
 - Awning or canopy
 - Transom above display window
 - First floor display window to expose the activity within
 - Recessed entry

Building Form

C34. Simple rectangular forms preferred.

- In Zone B, buildings with sloping roofs that reflect the residential tradition are also appropriate.

Relation of Building Exterior to Pedestrians

Facades with a high level of visual interest both at auto and pedestrian viewpoints, are encouraged. The exterior character of each building should enhance pedestrian activity in the immediate vicinity.

C35. Design walkways that encourage pedestrian use.

- Avoid locating walkways where users will be subjected to harsh glare from building materials, or where they will be subjected to harsh environmental conditions.

C36. Design the ground floor exterior of a building to be “pedestrian-friendly.”

- Decorative wall surfaces and landscape materials are encouraged at this level.
- Windows that can reveal indoor amenities and activities are encouraged.
- Avoid large expanses of blank walls or mirror glass at this level.

Building Entrances

Primary entrances should be easily identifiable and should relate to human scale.

C37. Develop main entrances to be clearly identifiable.

- Design building entrances to contrast with the surrounding wall plane.
- Create a frame around doorways, by changing materials from the primary facade material.
- Entrances should be well-lit.

Multiple Entrances

Many buildings will in fact be “double-fronted,” in that two facades will look out onto highly visible settings. Buildings that face edges along major streets while also facing into parking lots and landscaped spaces in the interior of the block are examples. Although one entrance is dominant, the second entrance is also significant.

C38. When two entrances are required for “double-fronted” buildings use the same standards for primary entrances.

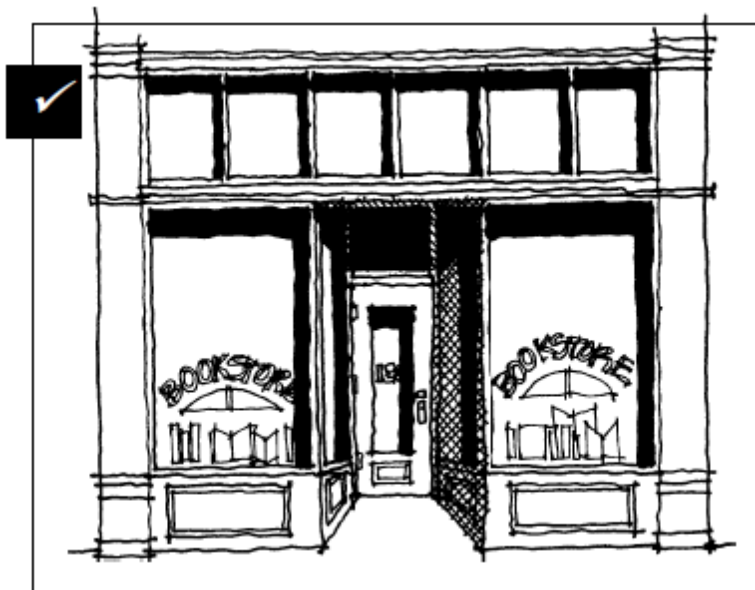

Recessed entrances are encouraged.

SECTION 7-203 PARKING LOT DESIGN STANDARDS

Surface Lots

Parking lots should be located and designed so they will provide efficient vehicular circulation and safe pedestrian circulation within the site, while minimizing the visual impact of cars. In general, parking areas should be a visual asset to the area, and large expanses of pavement should be avoided. On-street parking should be considered to accommodate some parking needs as well.

C39. Provide parking within convenient walking distance of building entrances.

- The maximum recommended walking distance from the farthest parking space to a building is 200 feet for guest parking, and 500 feet for employee parking.
- Greater walking distances may be considered where the pedestrian way is well-designed and encourages walking.

C40. Minimize the negative visual impact of cars parked on site.

- Screen parking areas from view of public ways and designated view corridors with landscaping.
- Divide parking lots into smaller areas with planted buffers between them to minimize the perceived scale of the total field of stalls.
- Locate parking lots behind buildings.

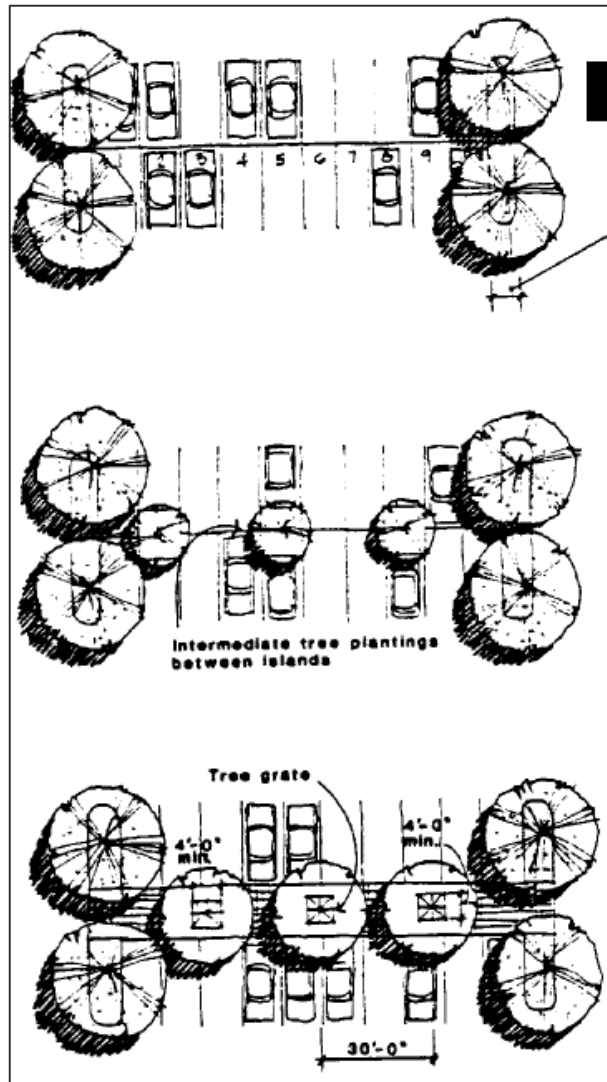

Minimize the negative visual impact of cars parked on site. Divide parking lots into smaller areas with planted buffers between them to minimize the perceived scale of the total field of stalls.

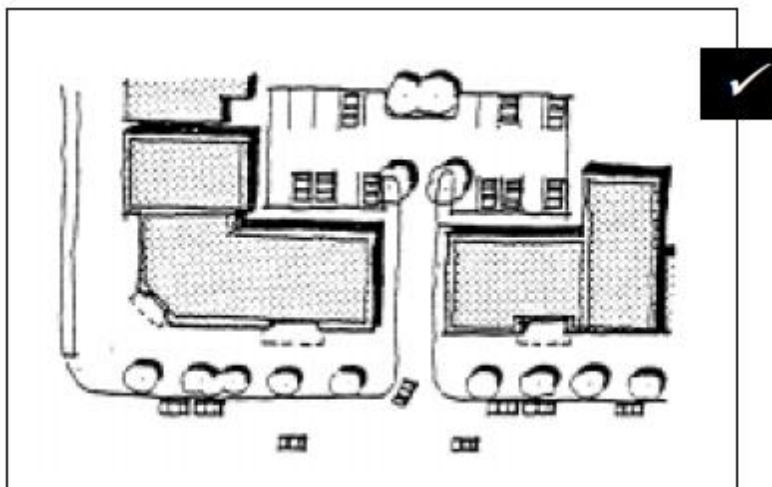

Siting parking lots behind buildings is preferred.

C41. Use those quantitative standards provided in the City of Little Rock's Code of Ordinances for the dimensions of standard and handicapped accessible parking spaces.

C42. Connect parking lots with convenient service ways between lots.

- Consider opportunities for cross-property easements to share driveways and reduce the need for additional curb cuts.

C43. Design parking lots to discourage high speed driving, especially near building entrances.

- Avoid aligning all travel lanes in parking lots in straight configurations that facilitate speeding.

C44. Design parking lots to avoid dead-end aisles.

- Where feasible, provide continuous access to adjacent parking aisles, lots or roads.
- Where dead-end situations are unavoidable, adequate space for unimpeded turnaround must be provided.

C45. Where parking lots are included in sites with steep slopes, minimize the slope of the paved areas.

- Consider terraced parking lot design solutions incorporating retaining walls with landscaping as the transition between levels.
- Paved parking areas should not exceed 7% in slope.

C46. Design parking lots to minimize surface runoff.

- Parking lots constitute a major portion of impervious surface area. Runoff from storms should be controlled to reduce impacts on storm drainage systems.
- The use of innovative state of the art porous paving systems which maximize infiltration of storm water into soils is encouraged. The use of gravel in parking lots shall be limited to lots accommodating 20 or less parking spaces.
- In contrast to large continuous paved lots, development of sets of smaller lots is encouraged, to accommodate infiltration systems.
- Drainage from parking areas should be dispersed in a manner that promotes infiltration and reduces erosion.
- Design drainage to sheet flow from paved areas across grass areas into grass swales.



Where feasible, provide continuous access to adjacent parking aisles, lots or roads.



Screen parking areas from view of public ways and designated view corridors with landscaping.

Special Parking Spaces

C47. Locate special parking spaces for van pool and car pool parking close-in to building entrances to encourage their use.

Parking Structures and Parking Under Buildings

The appearance of parking structures, either freestanding, or attached, should relate to the “parent” buildings and should positively contribute to the character of the site. Structures that are integrated into the main building are preferred.

C48. The general architectural standards shall apply to all parking structures; specifically with regard to mass, scale, and materials.

C49. The ground level of a parking structure should be wrapped by retail, office or some other active use along at least the primary street facade.

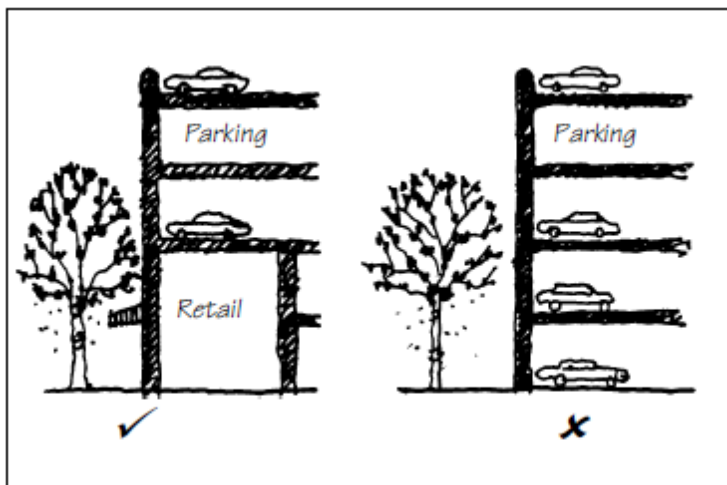

The ground level of a parking structure should be wrapped by retail, office or some other active use along at least the primary street facade.

C50. Screen cars from view from the ground level.

C51. Provide convenient, weather-protected pedestrian connections between parking structures and main buildings, and pickup points.

C52. Where parking levels are integrated into primary buildings, conceal the view of cars, especially at the first floor along the street and alley facades.

- Consider using decorative screens, murals, or plant materials that can provide interest to pedestrians.

C53. Soften the view of the top floor of the parking deck from view of upper floors of adjacent offices with architectural screens or landscaping.

- This is especially critical where deck tops will be visible from upper floors of buildings oriented toward designated view corridors.

SECTION 7-204 LANDSCAPE STANDARDS

Landscaping provides many benefits in an urban setting such as the Capitol Area. Landscaping: **1)** enhances the aesthetics of residential and commercial developments, **2)** creates a pedestrian friendly environment, **3)** breaks up the massing of buildings and expanses of parking areas, **4)** softens architectural materials, **5)** provides screening of service structures, **6)** enhances the streetscape environment, **7)** defines building and parking lot entrances, **8)** provides shade and climate control, **9)** controls airborne particulates, and **10)** provides buffers between incompatible land uses.

Refer to City of Little Rock Landscape Ordinance in addition to the following standards. If conflicts exist, these standards shall govern.

Visual Buffers

Visual buffers are to be used where parking and service areas negatively affect views. Buffers may be architectural, such as walls or fences, or may be composed of plantings.

C54. Use visual buffers to screen parking lots.

- Where a separation in grade is not possible, or when screening a service area, incorporate a hedge, fence, or wall.
- Trees and shrubs may be used separately or together to form an intensive plant screen.
- Use evergreen or deciduous shrubs to create hedges or screens. Deciduous shrubs should have a dense branching structure that begins close to the ground.

Retaining Walls

Retaining walls should be aesthetically pleasing structures in the landscape. Retaining walls offer many possibilities for uses aside from their main function. Stepped, tiered, or terraced retaining walls for instance, can also serve as seating, planting beds or bases for signs.

C55. Construct retaining walls of materials that harmonize with the surroundings in the area where they are built.

- Textured concrete or rock-faced walls are encouraged. Brick may be considered as well.
- Railroad ties and other wood materials are not allowed.

Public Art

Public art should be encouraged throughout the area. Public art can help to establish a strong visual identity for the area in its entirety, and for individual neighborhoods.

C56. Where feasible, provide public art for buildings larger than 40,000 square feet as part of the development of the parcel.

- Adjoining property owners are encouraged to develop shared artwork opportunities (i.e., in a shared plaza area).
- Locate the artwork so that it is reasonably visible or accessible to the public from a major street, or that is located at the building entrance.
- Gateways and special intersections are also excellent locations for public art.

Designing with the Topography

The natural contours of hillsides contribute to the distinct character of the Capitol Area and should be considered in site designs. Site plans should minimize the need for cut and fill. Where it does occur, it should be considered as an opportunity for positive enhancements through creative use of terracing and retaining walls.

C57. Develop site designs to enhance existing contours.

- Where changes in grade occur, design them as positive enhancements.
- Terrace buildings and parking areas to follow the topographic contours.
- Incorporate landscaping and retaining walls to provide transitions between levels.

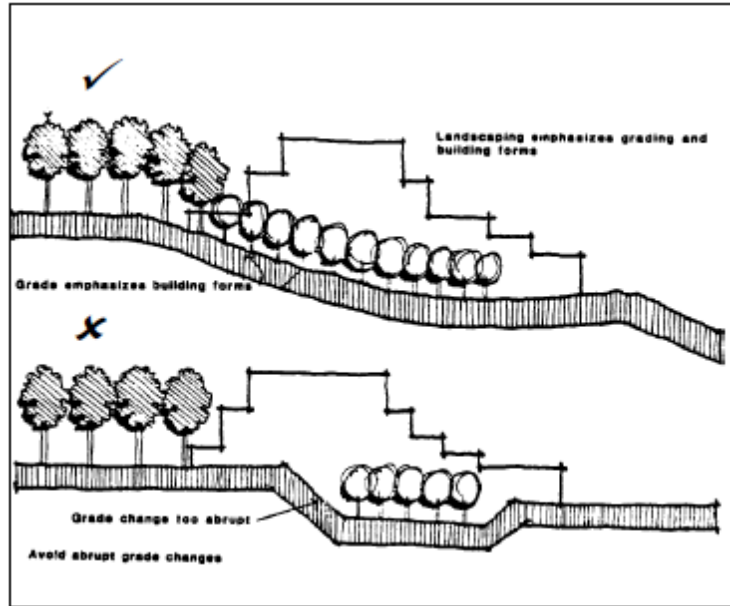

Develop site designs to enhance existing contours.

Plant Materials

C58. Drought tolerant plant species, native to the region and suitable to the climate in Little Rock, should be used.

- Use only recommended plant materials found in the City of Little Rock Landscape Ordinance. These lists identify preferred species that are best suited in the Little Rock area and require the least maintenance.

Landscape Quantity Requirements

C59. The quantitative plant material requirements contained in the City of Little Rock Landscape Ordinance should be followed, with the following exceptions:

- Although parking lots located in front yards are discouraged, there are instances where this condition already exists. In this case, the parking lot should be screened from any adjacent streets with a minimum six foot wide landscaped zone containing one tree per every 30 linear feet of frontage and 3 shrubs per every 10 linear feet of frontage.
- Low walls or fences may also be included in this zone.

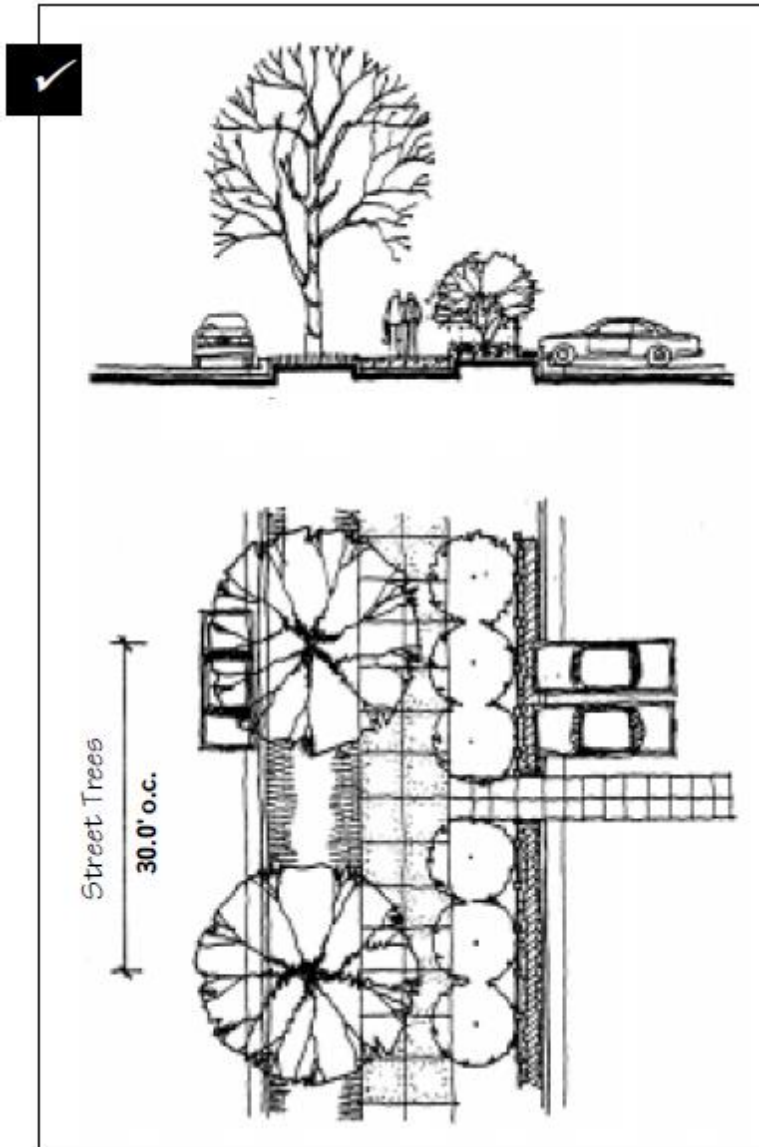

The quantitative plant material requirements contained in the City of Little Rock Landscape Ordinance should be followed.

Parking Lot Landscaping

C60. Parking lots should be designed to blend with each building site's character using landscape plantings and grading.

- Parking lots are necessary features of building sites that can, if not designed properly, visually detract from the overall development character.
- Terrace parking lots on steep slopes.
- For parking lots in excess of 40 spaces, provide a minimum of one tree per 10 spaces within the parking lot.
- Landscape a minimum of ten percent (10%) of each total parking lot (excluding the perimeter landscaping).
- Utilize landscaped islands and medians to provide the definition of circulation patterns, provide shading for parked cars and break up continuous rows of parking.
- The use of innovative, state of the art porous paving systems which maximize infiltration of storm water into soils is encouraged, when appropriate maintenance is assured.
- The use of gravel in parking lots shall be limited to lots accommodating up to 20 parking spaces.

ARTICLE EIGHT

MANSION AREA DESIGN STANDARDS

SECTION 8-101 INTRODUCTION

The following article applies to new construction in the Governor's Mansion Area of the Capitol Zoning District, as well as to work performed on non-historic existing structures and site features.

The Standards numbers in this article are preceded by either an "M" or "O." This signifies that the "M" standards are applicable in the Mansion Area in Zones M and N, and the "O" standards are applicable to projects in Zone O. The "O" standards for parking lot design and landscaping (Section 8-204), however, are applicable to most parking lots in the Governor's Mansion Area, regardless of zone or historic status. The "O" standards will also be applied when evaluating commercial-style new construction on corner lots (adjoining two public streets) in Zone N.



Simple rectangular forms and decorative details are typical features in the Mansion Area. A front porch faces the street.

A. The Basic Approach to Building in the Mansion Area

1. Designing a building to fit within the Mansion Area requires careful thought. First, it is important to realize that, while the Mansion Area conveys a certain sense of time and place associated with its history, it also remains dynamic, with improvements to existing structures and construction of new buildings occurring over time.
2. The Capitol Zoning District Commission strives to assure that, when new building occurs, it will be in a manner that reinforces the visual characteristics of the area. This does not mean, however, that new buildings must *look* old. While imitating historic styles is not discouraged; historians prefer to be able to "read" the evolution of the street, discerning the apparent age of each building by its style and method of construction. They do so by interpreting the age of a building, placing its style in relative chronological order. When a new building is designed to replicate a historic style, this ability to interpret the history of the street can be confused. New construction of historic styles should include materials or features to distinguish it as contemporary.
3. As an alternative to imitating older buildings, a new design may also relate to the historic design characteristics of the neighborhood while conveying the stylistic trends of today. New construction can do so by drawing upon certain building features—such as the way in which it is located on a site; the manner in which it relates to the street; and its mass, form and materials. When these design variables are arranged in a new building to be similar to those seen traditionally, visual compatibility results. Therefore, it is possible to be compatible with the historic context while also producing a design that is distinguishable as being newer than the historic buildings of the area.

Some people may be confused about this concept. For many, the initial assumption is that any new building in the area should appear to be old. On the contrary, the design standards that follow encourage new buildings that can be distinguished as being of their own time. However, they also promote new building designs that relate to the fundamental design features of the neighborhood. Some of these features are described in the section that follows. They are features that should be considered when planning new construction in the neighborhood.

B. Neighborhood Commercial Uses

The Mansion Area includes a special zoning category for commercial uses set in a context that traditionally was residential in character. For example, the portion of Main Street south of 19th Street is designated "N," which permits uses in a development pattern similar to that of traditional single-family buildings.

In this setting, commercial uses are to be located in structures that are similar in character to historic residential lots. Front setbacks are to appear as yards, building forms should reflect residential ones and commercial displays should be "low key."

C. Traditional Main Street Commercial Zone

Note that the northern portion of Main Street developed in a traditional commercial storefront context. Buildings are rectangular and align at the sidewalk edge. This distinctly different setting is to be maintained as a typical "main street" character, and it is zoned "O." A special set of design standards is provided for this area. Those standards are presented in Section 8-203.



The Capitol Zoning District Commission strives to assure that when new building occurs, it will be in a manner that reinforces the visual characteristics of the area.

SECTION 8-102 TRADITIONAL DEVELOPMENT CHARACTERISTICS OF THE MANSION AREA

The following section highlights some of the key features of the Mansion Area that should be respected in new construction.

A. Mansion Area Street Patterns

Historic development patterns seen in street and alley plans often contribute to the distinct character of the Mansion Area, and therefore they should be preserved. These street plans influence the manner in which primary structures are sited, and they also shape the manner in which secondary structures and landscape features may occur on the site.

B. Building Alignment

A front yard serves as a transitional space between the "public" sidewalk and the "private" building entry. In many blocks, front yards are similar in depth, resulting in a relatively uniform alignment of building fronts which contributes to the sense of visual continuity. Maintaining the established range of setbacks is therefore preferred.

C. Site Design

1. When considering the design features of individual building sites, a rich palette appears in the neighborhood. The similar orientation of buildings to the street, the variety of landscape designs, and the intermittent use of fences and rock retaining walls are among those site features that contribute to the character of the neighborhood.
2. Traditionally, a typical building had its primary entrance oriented to the street. This helped establish a "pedestrian friendly" quality, which encouraged walking. In most cases, similar entryways were evenly spaced along a block, creating a rhythm that also contributed to the sense of visual continuity for the neighborhood. This characteristic should be maintained where it exists. Locating the entrance of a new building in a manner that is similar to those seen traditionally is a means of doing so.

D. Mass and Scale

The mass and scale of a building also are important design issues in the Mansion Area. The traditional scale of single family houses dominates the neighborhood, and this similarity of scale also enhances the pedestrian-friendly character of many streets. Similarities in scale among prominent building features, such as porches and cornices, are also important.

E. Building Width

Many buildings were constructed similar in width to nearby structures. This helped to establish a relatively uniform scale for the neighborhood and, when these buildings were evenly spaced along a block, a sense of rhythm resulted. In such a case, the perceived width of a new building should appear similar to that of historic buildings in the neighborhood in order to help maintain this sense of visual continuity. For example, if a new building would be wider than those seen historically, it should be divided into modules that appear similar in width to traditional buildings.

F. Building Form

A similarity of building forms also contributes to a sense of visual continuity. In order to maintain this sense of visual continuity, a new building should have roof and building forms that are similar to those seen traditionally. Overall facade proportions also should be in harmony with the context.

G. Roofs

The character of the roof is a major feature of buildings in the Mansion Area. When repeated along the street, the repetition of similar roof forms also contributes to the sense of visual continuity. In each case, the roof pitch, its materials, size, and orientation are important to the overall character of the building. New construction should not break from this continuity. New structures and their roofs should be similar in character to their neighbors.

H. Solid-to-Void Ratio

A typical historic building appears to be a rectangular solid, with small holes “punched” in the walls for windows and doors. Most such buildings have similar amounts of glass, resulting in a relatively uniform solid-to-void ratio. This ratio on a new building, the amount of facade that is devoted to wall surface as compared to that developed as openings, should be similar to that of historic buildings within the neighborhood.

I. Materials

Building materials of new structures and additions to existing structures should contribute to the visual continuity of the neighborhood. They should appear similar to those seen traditionally to establish this sense of continuity.

J. Architectural Details

Entries are clearly defined on most structures in the neighborhood. Porches, porticos and stoops are elements that typically define entries. These features add a one-story element to the fronts of buildings, helping to establish a uniform sense of human scale along the block. They are essential elements of the neighborhood that should be maintained. Other architectural details also contribute to the sense of character of the street, adding visual interest for pedestrians. Their continued use is strongly encouraged.

K. Windows

The similarity of window size and location contributes to a sense of visual continuity along the street. In order to maintain this sense of visual continuity, a new building should reflect the basic window proportions and placement of openings that were seen traditionally.

L. Doors

The similarity of door size and location contributes to a sense of visual continuity along the street. In order to maintain this sense of visual continuity, a new building should maintain the door proportions and orientation seen traditionally in the neighborhood.

M. Architectural Styles

In the case of new construction, these design standards focus on where a building should be located on a site and what its scale and character should be. They do not dictate the style of the new building or the degree of detail that it should have. (In fact, imitating historic styles may be considered.)

SECTION 8-201 DESIGN STANDARDS FOR NEW CONSTRUCTION IN ZONES “M” & “N”

These Design Standards are for new construction in Zones "M" and "N" in the Mansion Area. These districts developed with a traditional single family residential character, which is to be continued in renovations and new construction. These standards therefore provide criteria for new buildings to be built in a manner that will be compatible with this established context.

Note that, in addition to these standards, General Standards may also apply. For properties that involve a historic structure and/or site features, the Standards for Rehabilitation also apply.

Policy:

Creative new construction that is compatible with the historic character of the neighborhood is strongly encouraged. New buildings need not imitate older styles, and designs that contrast with the existing context simply for the sake of being different are discouraged.

District Street Patterns

M1. Respect historic development patterns.

- Site a new building such that it is arranged on its site in a way similar to historic buildings in the area. This includes consideration of building setbacks and open space.

M2. Maintain the traditional character of alleys.

- Maintain the traditional character and scale of an alley by locating buildings and fences along the alley edges to maintain the narrow width.



The new infill building on the left respects the historic settlement pattern.

Building Alignment

A front yard setback serves as a transitional space between the public sidewalk and the private building entry. When repeated along the street, these yards enhance the character of the neighborhood and provide interest to pedestrians. In many blocks, the relatively uniform alignment of building fronts contributes to a sense of visual continuity that should be preserved.

M3. Locate a new building within the range of setbacks seen traditionally in the block.

- These include:

Front yard setbacks

Side yard setbacks

Rear yard setbacks

- In some areas, setbacks vary but generally fall within an established range. A greater variety in setbacks is appropriate in this context.

Site Design

M4. Provide a front yard similar in depth to neighboring properties.

- See the setback requirements stipulated in the zoning code.

M5. Minimize the amount of hard surface paving for patios, terraces and driveways.

- A grass lawn should be the dominant material of a front yard.
- The use of rock and gravel is discouraged, and if used, should only occur as an accent element.

M6. If it is to be used, a fence should be in character with those seen historically.

- A fence that defines a front yard is usually low to the ground; less than 40 inches.
- Transparent elements, such as wood picket or wrought iron, are appropriate.
- Privacy fences may be used in back yards and along alleys.
- Chain link and solid "stockade" fences are discouraged in front and side yards when they face the street.
- Contemporary interpretations of traditional fences should be compatible with the historic context.
- Note that using no fencing at all is often the best approach.
- See also the standards on fences as found in the Rehabilitation Standards for Historic Properties.

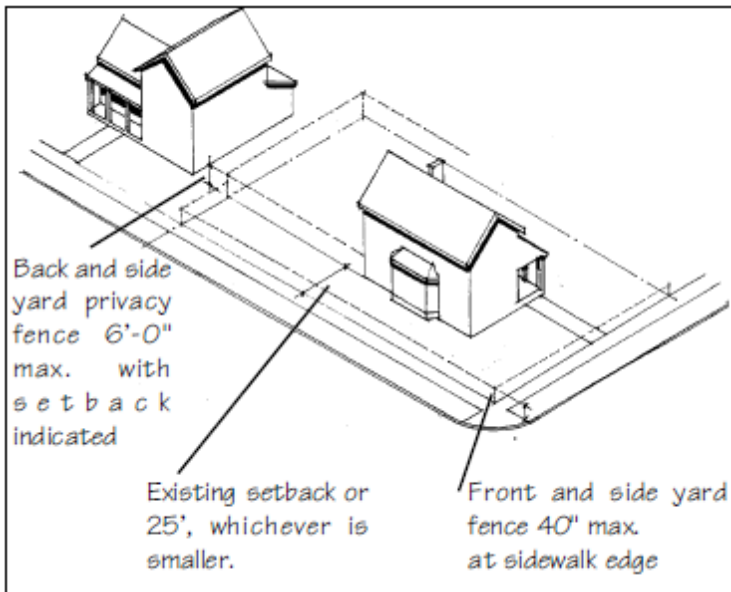

Fence height and setback requirements for a corner lot with an adjacent structure to the rear.



This is a good example of how landscaping further enhances the owner's sense of privacy.

M7. Provide a progression of public-to private spaces when planning a new structure.

- This includes a sequence of experiences, beginning with the "public" sidewalk, proceeding to a "semipublic" walkway, to a "semiprivate" porch or entry feature and ending in the "private" spaces beyond.
- Provide a walkway running perpendicular from the street to the front entry.
- Multi-family housing should address the street in a manner similar to that of traditional single family residences.

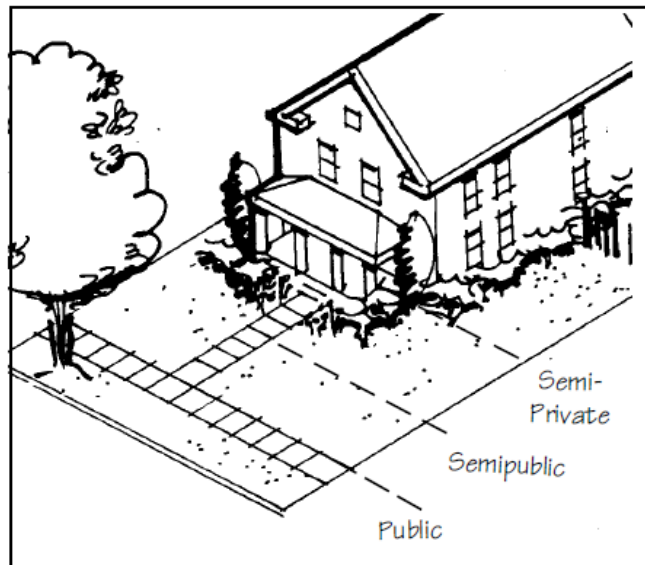

Maintain the established progression of spaces in front of a building. This includes a detached sidewalk, front lawn, walkway and porch.

Building Orientation

M8. Orient the front of a primary structure to the street.

- The building should be positioned parallel to the lot lines, maintaining the traditional grid pattern of the block.

M9. Orient the primary entry of a building to the street.

- In some cases, the front door itself is positioned perpendicular to the street. In addition to the front door the entry should be clearly defined with a walkway and porch that also orients to the street.

M10. Clearly define the primary entrance by using a front porch.

- The front porch should be "functional" in that it is used as a means of access to the entry.

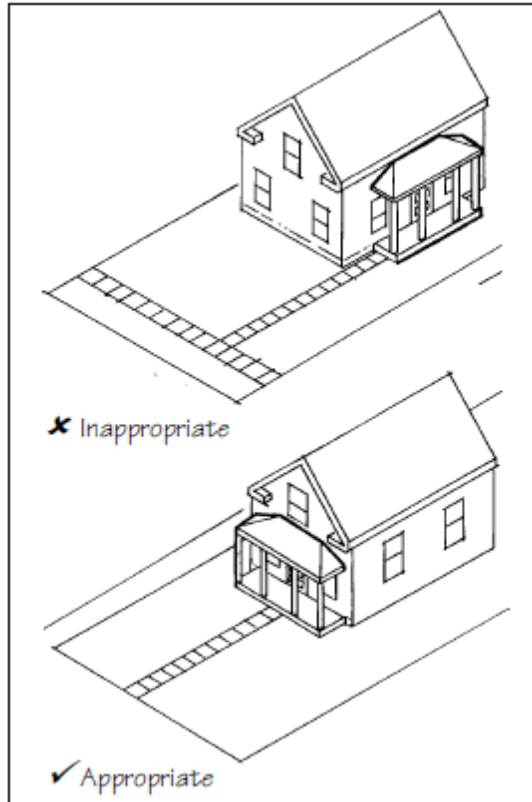

Orient the primary entry of a building to the street. Clearly define the primary entrance by using a front porch.

Mass and Scale

M11. Construct a new building to appear similar in mass and scale to single-family residences seen historically.

- Provide a porch that is similar to those seen traditionally.
- Include landscape elements, such as fences and walkways, similar in scale to those seen traditionally.

M12. On larger structures, subdivide the mass into smaller "modules" that are similar in size to single-family residences seen traditionally.

- Other, subordinate modules may be attached to the primary building form.

M13. The primary plane of the front should not appear taller than those of typical historic structures in the neighborhood.

- No building may exceed two and one-half stories in height.
- Wall heights of one and one-and-one half stories are appropriate along the street in some blocks where this is the established building scale.



This new infill building appears similar in mass and scale to single-family residences seen traditionally.

Building Width

M14. Design a new building to appear similar in width to that of nearby single family structures.

- If a building would be wider overall than structures seen historically, the facade should be divided into subordinate planes that are similar in width to those of the historic context.

Building Form

M15. Use building forms that are similar to those seen traditionally.

- Simple rectangular solids are appropriate.
- Exotic building and roof forms that would detract from the visual continuity of the street are discouraged.

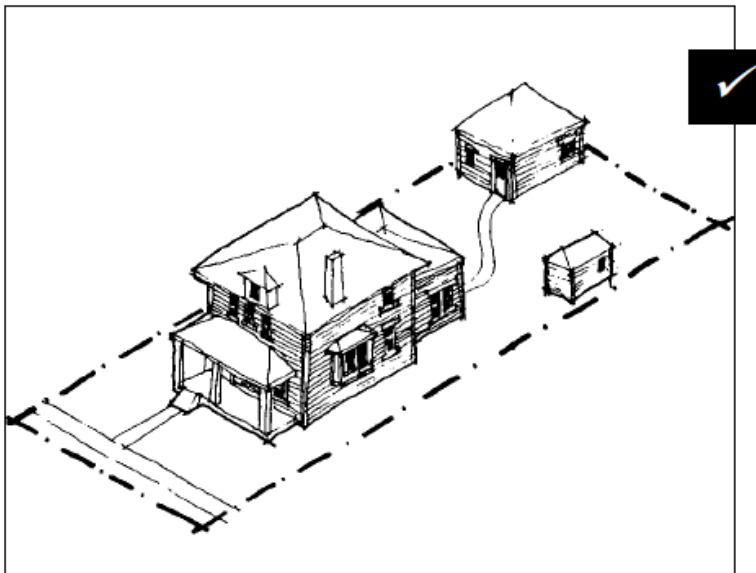

Use building forms that are similar to those seen traditionally.

Roofs

M16. Use roof forms that appear similar to those seen traditionally.

- Sloping roofs such as gable and hip forms are appropriate. The pitch should be similar to those of historic buildings in the area.
- The primary ridge line of a residential roof should not exceed the historic maximum for the block.
- Shed roofs may also be considered for minor rear additions.
- Eave depths should be similar to those seen traditionally in the neighborhood.
- Because they break up the perceived scale of a roof, using dormers is also encouraged.

M17. Roof materials should appear similar in character to those used historically.

- The material should appear similar in scale and finish to those used traditionally. It should be of earth tones and have a matte, non-reflective finish.
- Composition shingles are appropriate. Tile, slate and metal may also be considered.
- Rolled roofing, glossy plastic and other highly reflective finishes are inappropriate.



Commercial uses that are permitted in the "N" zone should also use elements that draw upon the traditions of residential structures seen historically in the area. This includes traditional roof forms.

Solid-to-Void Ratio

M18. Use a ratio of solid-to-void (wall-to-window) that is similar to that found on historic structures in the area.

- Large surfaces of glass are generally inappropriate. Divide large glass surfaces into a smaller set of windows that are similar to those seen traditionally.

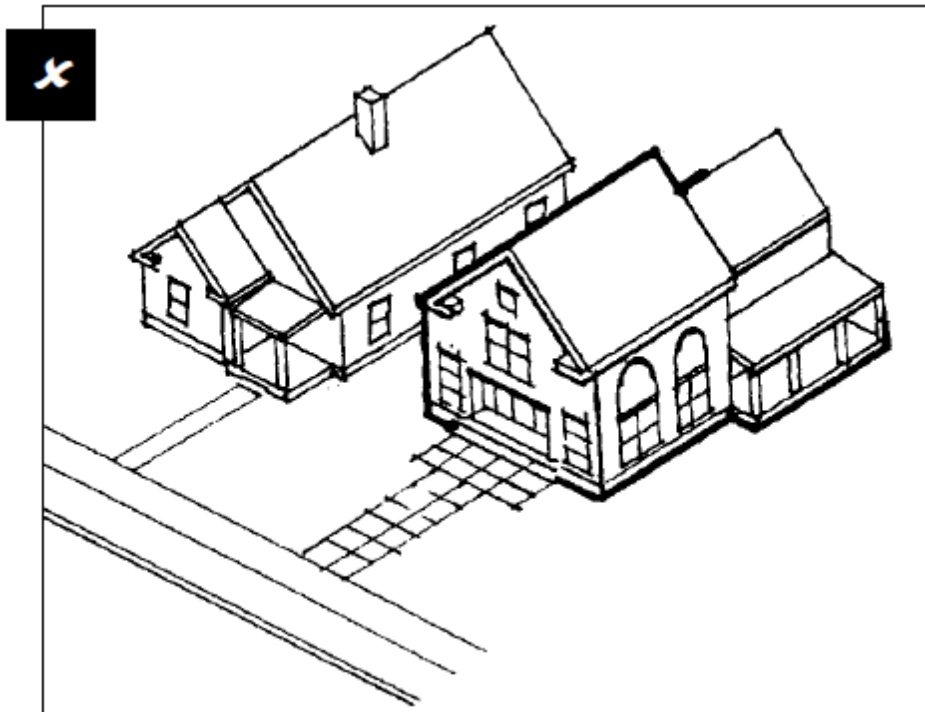

Use a ratio of solid-to-void (wall-to-window) that is similar to that found on historic structures in the district. Large surfaces of glass are generally inappropriate.

Materials

M19. Use building materials that appear similar to those used traditionally.

- Horizontal lap siding is preferred in most applications. All wood siding should have a weather-protective finish.
- Brick should have a modular dimension similar to that used traditionally.
- Stone, similar to that used traditionally, is also appropriate.
- Stucco may be considered as a secondary material, for foundations and subordinate wings.
- Use of highly reflective materials is discouraged.

M20. New materials that are similar in character to traditional ones may be considered.

- Alternative materials should appear similar in scale, texture and finish to those used historically. They also should have a proven durability in similar applications.
- For example, synthetic siding may be considered for a *new* building if the dimension of the exposed lap is similar to that used historically, and the finish, texture and trim elements are also in character.

M21. Use building materials that contribute to the traditional sense of scale of the block.

- This will reinforce the sense of visual continuity in the district.
- Brick units that are similar in size to those used traditionally, for example, help to establish a sense of scale.

Architectural Character

M22. If they are to be used, ornamental elements should to be in scale with similar historic features.

- This includes brackets, porch trim and window frames.
- Thin, fake brackets and strap work applied to the surface of a building are inappropriate uses of these traditional details.

M23. The imitation of older historic styles is will be considered.

- One should take care when imitating historic styles because this can blur the distinction between old and new buildings, and make it more difficult to visually interpret the architectural evolution of the district. A new building designed in a historic style should incorporate materials or features to distinguish it as a product of its own time.
- Drawing upon elements of a traditional style in a manner that will convey a new building as being of its own time while maintaining a sense of compatibility with the historic context, however, is encouraged. See below.

M24. Contemporary interpretations of traditional details are encouraged.

- New designs for window moldings and door surrounds, for example, can provide visual interest while helping to convey the fact that the building is new. Contemporary details for porch railings and columns are other examples.



Contemporary interpretations of trim details and window moldings can provide visual interest while helping to convey the fact that the building is new.



Contemporary interpretations or ornamental details, such as porch trim are encouraged.

Windows

M25. Windows should appear similar in character to those of historic buildings in the area.

- Windows on primary facades should be similar in size and shape to those seen traditionally.

M26. Windows with vertical emphasis are encouraged on primary facades.

- A general rule is that the height of the window should be twice the dimension of the width in most residential contexts.

M27. Frame windows in materials that appear similar in scale, proportion and character to those used traditionally in the neighborhood.

- Double-hung windows with traditional depth and trim are preferred.
- However, other materials may be considered if the appearance is similar to that of the historically significant wood window in dimension, profile and finish.
- Windows should be trimmed in wood. This trim must have a dimension similar to that used historically.
- See also the General Standards for Windows for more information.

M28. Windows should be simple in shape.

- Odd window shapes such as octagons, circles, diamonds, etc., are discouraged.
- On some styles, octagonal and diamond-shaped windows were used as accents in the gable end of a front facade. If appropriate to the building style, ornamental windows may be used sparingly.



Windows should be simple in shape.

M29. Dormers should be in scale with those used traditionally in the area.

- Dormers should be subordinate to the roof itself, and lower than the ridge line.

New Secondary Structures

M30. A secondary structure should be compatible with the primary building.

- While the roof line does not have to match the house, it is best that it not vary significantly.



This new secondary structure is a contemporary interpretation of the traditional building and is compatible with the historic context.

M31. A secondary structure should be similar in character to those seen traditionally.

- Basic rectangular forms, with hip, gable or shed roofs, are appropriate.
- Contemporary interpretations of traditional secondary structures should be permitted when they are compatible with the historic context.

M32. In general, garages should be unobtrusive and not compete visually with the house.

- A detached garage is preferred. This will help reduce the perceived mass of the overall development.
- When the garage must be attached, the percentage of building front allocated to it should be minimized.

M33. Locating a garage such that its visual impacts will be minimized is encouraged.

- Provide access to parking from an alley.
- Locating a garage in the front yard is discouraged.
- If a garage must be accessed from the street, set it back at least ten feet behind the primary building facade.

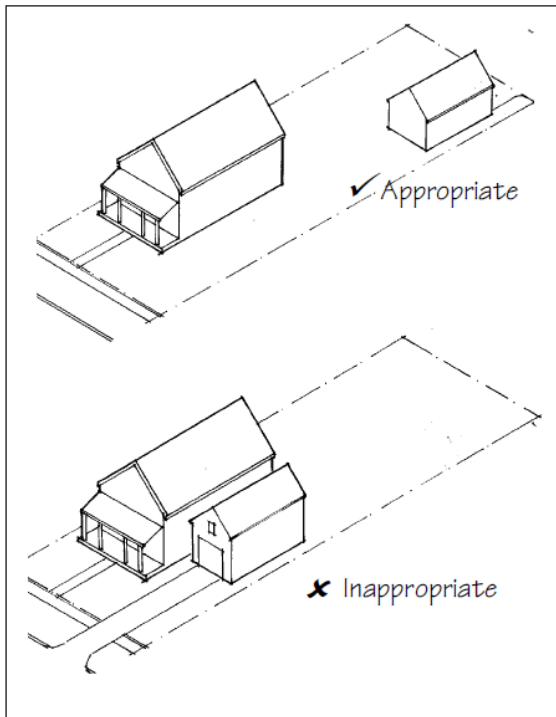

Locate a secondary structure to the rear of the lot.

SECTION 8-202 TRADITIONAL DEVELOPMENT CHARACTERISTICS IN ZONE "O"

Building in Zone "O" should reinforce the traditional storefront commercial character of the area. These design standards focus on those elements of the historic context that reflect this early character.

Traditionally, this portion of Main Street was animated with commercial activity. Storefronts provided views to goods and services inside ground floor shops, and the sidewalk was active with pedestrians. While variety existed in building designs, a general sense of continuity prevailed, and interesting details established a human scale that invited pedestrian activity. This encouraged walking to shops on Main Street from nearby neighborhoods, a goal that exists for today.

New buildings should respect Main Street's established character, but need not literally imitate historic building styles. Instead, contemporary interpretations of historic commercial building types are encouraged.

A. Building Alignment

Historically, buildings created a strong edge to the street because they aligned at the front lot line and usually were built the full width of the parcel to the side lot lines.

B. Mass and Scale

Patterns are created along the street by the repetition of similarly-sized building elements. For example, uniform facade widths evenly spaced along Main Street create a rhythm that contributes to the visual continuity of the area. At a smaller scale, the repetition of upper story windows across most building fronts also creates a unifying effect. These patterns should be respected in all new construction.

C. Building Form

Historically, one of the most prominent unifying elements of Main Street was the similarity of building forms. Commercial buildings were simple rectangular solids, deeper than they were wide. This characteristic is important and should be continued in new projects.

D. Materials

Building materials should contribute to the visual continuity of the neighborhood. They should appear similar to those seen traditionally to establish a sense of visual continuity.



Traditionally, this portion of Main Street was animated with commercial activity. Storefronts provided views to goods and services inside ground floor shops, and the sidewalk was active with pedestrians.

E. Architectural Character

The repetition of similar facade elements greatly contributes to the historic character of the street. In particular, windows, architectural details, ornaments, and cornice moldings reoccur frequently. These details have "depth"; they cast shadow lines and add a three-dimensional feel to the facade.

F. Storefronts

The street level floors of traditional Main Street commercial buildings are clearly distinguishable from the upper floors. First floors are predominantly fixed plate glass with a small percentage of opaque materials. Upper floors are the reverse; opaque materials dominate, and windows appear as smaller openings puncturing the solid walls. These windows are usually double-hung. The street level is generally taller than the upper floors.



The primary entrances to buildings are recessed, providing a shaded area that helps to define doorways and to provide shelter to pedestrians. This feature should be repeated on new infill buildings along Main Street.

G. Entries

Most primary entrances to buildings are recessed, providing a shaded area that helps to define doorways and to provide shelter to pedestrians. Entrance doors were topped with transom windows that enhanced the vertical emphasis of these openings. The repetition of primary entrances along the street contributes to the traditional or human scale of the area, and should be continued in future projects.

H. Responding to Incongruous Changes

In recent years, portions of this part of Main Street lost their historic character. Original buildings were demolished and newer ones sought to emulate building types popular in strip commercial areas. Such buildings were set back from the sidewalk edge, with parking in front. This development eroded the traditional character of the sidewalk and diminished the sense of visual continuity. These properties do not represent a part of the context that should be repeated in new construction. Instead, new development should reflect the historic features of the area and help to reestablish the continuity of the line of commercial storefronts that is the area's heritage.

SECTION 8-203 DESIGN STANDARDS FOR ZONE "O"

Policy: Creative solutions that are compatible with the historic character of the neighborhood are strongly encouraged, while designs that seek to contrast with the traditional context simply for the sake of being different are discouraged.

Pedestrian Activity

O1. Develop the ground floor level of all projects to encourage pedestrian activity.

- Use commercial storefronts to provide pedestrian interest along the street. Commercial storefronts should include traditional elements such as display windows, kickplates, and transoms.
- Large storefront display windows, located at the street level where goods or services are visible from the street, are particularly encouraged.
- Primary building entrances should be at street level.

Building Alignment

O2. Maintain the alignment of facades at the sidewalk's edge.

- Placing the facade of the building at the property line is required by the General Standards and should be modified only in special circumstances. Locating entire building fronts behind the established storefront line is inappropriate.
- Parking should not be located in front of the building.

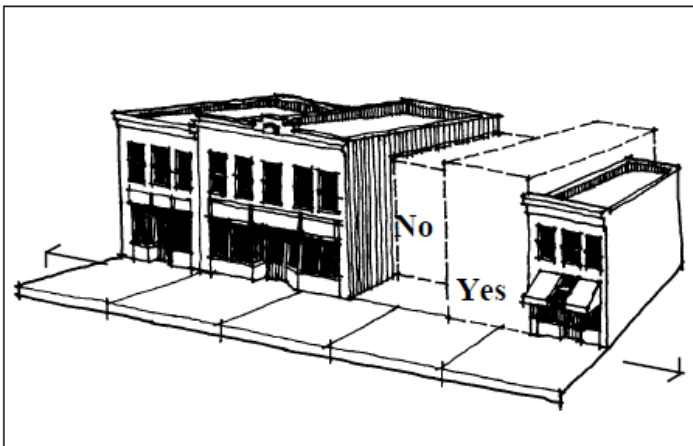

Maintain the alignment of building facades at the sidewalk edge.

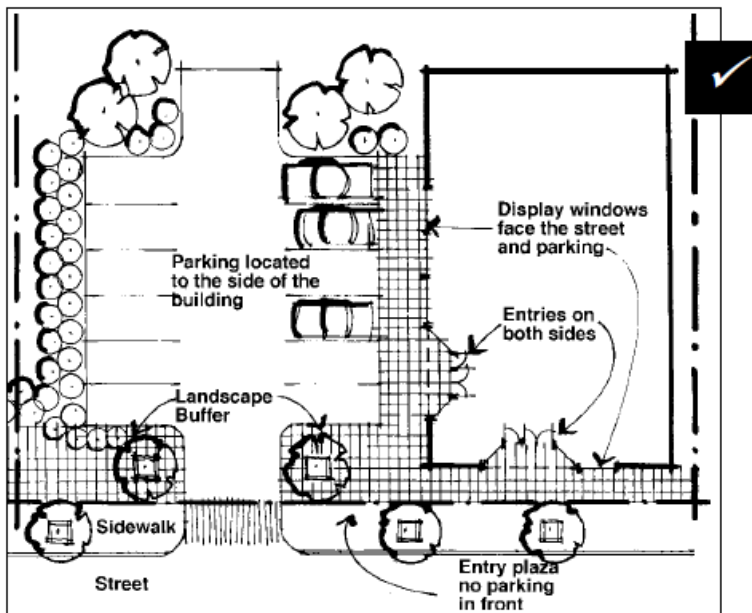

In Zone "O," locate a new building at the sidewalk edge. If parking also is to be provided, locate it in the rear or to the side of the structure, and screen it with landscaping.

Building Mass & Scale

O3. Maintain the average scale of two story buildings at the sidewalk.

- New construction should present a tall one-story or two story façade at the front property line.
- Façade heights of new buildings should fall within the established range of the block and respect the historic proportions of height to width.
- Floor-to-floor heights should appear similar to those of historic buildings in the area.

O4. Traditional spacing patterns created by the repetition of similar building widths should be maintained.

- Building widths typically were between 25 and 50 feet. No facade should exceed 50 feet without a clear expression of this standard module.
- Where buildings are planned to exceed this width, use a change in design features to suggest the traditional building widths. Changes in facade material, window design, facade height, or decorative details are examples of techniques that may be considered.

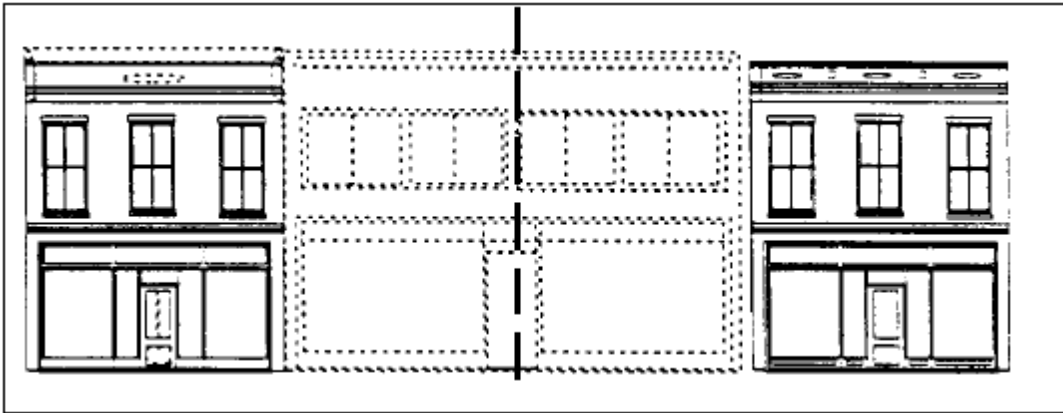

Divide larger buildings into bay widths similar to those found historically. Upper story windows with vertical proportions are also appropriate.

Building Form

O5. The basic building form should be rectangular.

- Rectangular forms should be vertically oriented.
- The facade should appear as predominantly flat, with any decorative elements and projecting or setback "articulations" appearing to be subordinate to the dominant form.



The basic building form should be rectangular and a flat roof should dominate, as shown on this traditional building along Main Street.

Roofs

O6. A flat roof should be the dominant roof form.

- Parapets with horizontal emphasis are appropriate.
- Parapets on side facades should step down towards the rear of the building.

Materials

O7. Use building materials that are similar to those employed historically for all major surfaces.

- Materials should be similar in appearance to those used historically. New materials may be used if their appearances are similar in scale, texture and finish to those of the historic building materials.
- Brick, similar in scale and color to that seen historically, is preferred. Stucco may be considered if detailed to express traditional trim elements and building module dimensions.

Architectural Character

O8. The general alignment of horizontal features on building fronts should be maintained along Main Street.

- Typical elements that align include window moldings, tops of display windows, cornices, copings and parapets at the tops of buildings.

O9. Special features that highlight buildings on corner lots may be considered.

- Develop both street elevations to provide visual interest to pedestrians.
- Corner entrances, bay windows and towers are examples of elements that may be considered to emphasize corner locations.
- Storefront windows, display cases and other elements that provide visual entrances to facades along side streets are also appropriate.

Storefronts

O10. Use traditional storefront components at the street level.

- The first floor of the primary facade should be predominantly transparent glass. Maintain the full height of this area in glass.
- Highly reflective or darkly tinted glass is inappropriate.
- Express the traditional distinction in floor heights between street levels and upper levels through detailing, materials and fenestration. The presence of a belt course is an important feature in this relationship.



The first floor of the primary facade should be predominantly transparent glass. This contemporary interpretation of the traditional storefront includes a transom above the main storefront, which is an appropriate approach. The use of brick is encouraged.



Contemporary interpretations of traditional storefront elements are encouraged. An awning also may be used. The awning fits within the dimensions of the storefront modules, which helps express the proportions of the building. The storefront module helps to keep it in scale with the historic commercial storefronts in the area.

Upper Story Windows

O11. Maintain the traditional spacing pattern created by upper story windows.

- Upper floors should be perceived as being more opaque than the lower floor.
- Also express the proportions of historic windows.
- Headers and sills of windows on new buildings should maintain the traditional placement relative to cornices and belt courses.

Entries

O12. Maintain the pattern created by recessed entry ways.

- Set the door back from the front an adequate amount to establish a distinct threshold for pedestrians.



Provide a recessed entry.

SECTION 8-204 PARKING AREAS AND LANDSCAPING

This section continues the series of “O” standards, but may be applied to most parking areas in the Mansion Area, regardless of zone or whether the property includes a historic structure or site features. For larger parking lots (20+ spaces) in the Mansion Area, the design standards for parking lots and landscape for the Capitol Area may also be applicable. In all cases, the General Standards for parking prescribe the number, size, and location of parking spaces.

Parking Lots

Parking lots should be located and designed so they will provide efficient vehicular circulation and safe pedestrian circulation within the site while minimizing the visual impact of cars. In general, parking areas should be a visual asset to the area, and large expanses of pavement should be avoided. On-street parking should be considered to accommodate some parking needs as well.

O13. Provide parking within convenient walking distance of building entrances.

O14. Minimize the negative visual impact of cars parked on site.

- Screen parking areas from view of public ways and designated view corridors with landscaping.
- Divide parking lots into smaller areas with planted buffers between them to minimize the perceived scale of the total field of stalls.
- Locate parking lots behind buildings.

O15. Parking lots should be designed to blend with each building site's character using landscape plantings and grading.

- Parking lots can, if not designed properly, visually detract from the overall development character.
- Terrace parking lots on steep slopes.
- Utilize landscaped islands and medians to define circulation patterns, provide shade for parked cars and break up continuous rows of parking.
- Low walls or fences may also be included in the landscaped area.

Visual Buffers

Visual buffers are to be used where parking and service areas negatively affect views. Buffers may be architectural, such as walls or fences, or may be composed of plantings.

O16. Use visual buffers to screen parking lots.

- Where a separation in grade is not possible, or when screening a service area, incorporate a hedge, fence or wall.
- Trees and shrubs may be used separately or together to form an intensive plant screen.
- Use evergreen or deciduous shrubs to create hedges or screens. Deciduous shrubs should have a dense branching structure that begins close to the ground.

Public Art

Public art should be encouraged throughout Zone O. Public art can help to establish a strong visual identity for the area in its entirety and the adjacent neighborhoods.

O17. Where feasible, provide public art for buildings larger than 40,000 square feet as part of the development of the parcel.

- Adjoining property owners are encouraged to develop shared artwork opportunities (i.e., in a shared plaza area).
- Locate the artwork at the building entrance or so that it is reasonably visible or accessible to the public from a major street.
- Gateways and special intersections also are excellent locations for public art.

Plant Materials

O18. Drought tolerant plant species, native to the region and suitable to the climate in Little Rock, should be used.

- Use the recommended plant materials listed in the City of Little Rock Landscape Ordinance. These preferred species are best suited in the Little Rock area and require the least maintenance.